

# Operating Manual

Translation of the original operating manual

## MKF (E4)

Alternating climate chambers with program control

Model	Model version	Art. No.
MKF 56	MKF056-230V	9020-0317, 9120-0317
	MKF056-240V	9020-0396, 9120-0396
MKF 115	MKF115-400V	9020-0207, 9120-0207
	MKF115-400V-C	9020-0357 (with voltage and frequency changer)
MKF 240	MKF240-400V	9020-0208, 9120-0208
	MKF240-400V-C	9020-0358 (with voltage and frequency changer)
MKF 720	MKF720-400V	9020-0210, 9120-0210
	MKF720-400V-C	9020-0359 (with voltage and frequency changer)

## MKFT (E4)

Alternating climate chambers with deep temperature with program control

Model	Model version	Art. No.
MKFT 115	MKFT115-400V	9020-0211, 9120-0211
	MKFT115-400V-C	9020-0362 (with voltage and frequency changer)
MKFT 240	MKFT240-400V	9020-0212, 9120-0212
	MKFT240-400V-C	9020-0361 (with voltage and frequency changer)
MKFT 720	MKFT720-400V	9020-0228, 9120-0228
	MKFT720-400V-C	9020-0360 (with voltage and frequency changer)

### BINDER GmbH

- ▶ Address: Post office box 102, 78502 Tuttlingen, Germany ▶ Phone: +49 7462 2005 0
- ▶ Fax: +49 7462 2005 100 ▶ Internet: <http://www.binder-world.com>
- ▶ E-mail: [info@binder-world.com](mailto:info@binder-world.com) ▶ Service Hotline: +49 7462 2005 555
- ▶ Service Fax: +49 7462 2005 93 555 ▶ Service E-Mail: [service@binder-world.com](mailto:service@binder-world.com)
- ▶ Service Hotline USA: +1 866 885 9794 or +1 631 224 4340 x3
- ▶ Service Hotline Asia Pacific: +852 390 705 04 or +852 390 705 03
- ▶ Service Hotline Russia and CIS: +7 495 988 15 16

---

## CONTENTS

<b>1. SAFETY</b> .....	<b>7</b>
1.1 Legal considerations .....	7
1.2 Structure of the safety instructions.....	7
1.2.1 Signal word panel .....	7
1.2.2 Safety alert symbol .....	8
1.2.3 Pictograms .....	8
1.2.4 Word message panel structure.....	9
1.3 Localization / position of safety labels on the chamber .....	9
1.4 Type plate .....	11
1.5 General safety instructions on installing and operating the chamber .....	12
1.6 Intended use .....	14
1.7 Operating instructions .....	14
1.8 Measures to prevent accidents .....	15
1.9 Resistance of the humidity sensor against harmful substances .....	16
<b>2. CHAMBER DESCRIPTION</b> .....	<b>17</b>
2.1 Chamber overview .....	18
2.2 Instrument panel .....	18
2.3 Lateral control panel.....	19
2.4 Main power switch (MKF 56).....	20
2.5 Rear power switch (MKF / MKFT 115, 240, 720) .....	20
2.6 Rear chamber view .....	21
<b>3. COMPLETENESS OF DELIVERY, TRANSPORTATION, STORAGE, AND INSTALLATION</b> .....	<b>23</b>
3.1 Unpacking, and checking equipment and completeness of delivery .....	23
3.2 Guidelines for safe lifting and transportation.....	24
3.3 Storage.....	24
3.4 Location of installation and ambient conditions .....	25
<b>4. INSTALLATION AND CONNECTIONS</b> .....	<b>27</b>
4.1 Wastewater connection for humidifying system.....	27
4.2 Freshwater supply for humidifying system.....	27
4.2.1 Automatic fresh water supply for humidifying system via water pipe .....	28
4.2.2 Manual fresh water supply via external freshwater can (option for MKF 56) .....	28
4.2.3 Manual fresh water supply for humidifying system via internal freshwater can (MKF/MKFT 115, 240, 720).....	28
4.2.4 Water circle: lever for condensate recycling (option for MKF/MKFT 115, 240, 720).....	29
4.3 Connection of cooling water outlet for water cooling (option) .....	29
4.4 Connection of cooling water inlet for water cooling (option) .....	30
4.5 Connection kit for connecting the chamber's freshwater connection to a water pipe.....	30
4.6 Safety kit: Hose burst protection device with reflux protection device for the chamber's freshwater connection (available via BINDER INDIVIDUAL customized solutions).....	31
4.7 Installation of the voltage and frequency changer (chambers with voltage and frequency changer).....	33
4.8 Electrical connection .....	34
4.8.1 Information on connecting the alternating climate chamber .....	34
4.8.2 Connecting the voltage and frequency changer (for chambers equipped with a voltage and frequency changer) .....	35
<b>5. FUNCTIONAL OVERVIEW OF THE MB2 CHAMBER CONTROLLER</b> .....	<b>37</b>
5.1 Operating functions in normal display .....	38
5.2 Display views: Normal display, program display, chart-recorder display.....	39
5.3 Controller icons overview .....	40
5.4 Operating modes.....	42

5.5	Controller menu structure.....	43
5.5.1	Main menu .....	44
5.5.2	“Settings” submenu.....	45
5.5.3	“Service” submenu.....	45
5.6	Principle of controller entries.....	46
5.7	Performance during and after power failures.....	46
5.8	Performance when opening the door.....	47
<b>6.</b>	<b>START UP .....</b>	<b>47</b>
6.1	Turning on the chamber.....	47
6.2	Controller settings upon start up.....	48
6.3	Turning on/off humidity control.....	49
<b>7.</b>	<b>SET-POINT ENTRY IN “FIXED VALUE” OPERATING MODE.....</b>	<b>49</b>
7.1	Set-point entry through the “Setpoints” menu.....	50
7.2	Direct setpoint entry via Normal display.....	51
7.3	Special controller functions via operation lines.....	51
<b>8.</b>	<b>TIMER PROGRAM: STOPWATCH FUNCTION .....</b>	<b>52</b>
8.1	Starting a timer program .....	52
8.1.1	Performance during program delay time .....	53
8.2	Stopping a running timer program .....	53
8.2.1	Pausing a running timer program .....	53
8.2.2	Cancelling a running timer program.....	53
8.3	Performance after the end of the program.....	53
<b>9.</b>	<b>TIME PROGRAMS .....</b>	<b>54</b>
9.1	Starting an existing time program .....	54
9.1.1	Performance during program delay time .....	55
9.2	Stopping a running time program.....	55
9.2.1	Pausing a running time program.....	55
9.2.2	Cancelling a running time program.....	55
9.3	Performance after the end of the program.....	55
9.4	Creating a new time program.....	56
9.5	Program editor: program management.....	56
9.5.1	Deleting a time program .....	57
9.6	Section editor: section management.....	58
9.6.1	Add a new program section .....	59
9.6.2	Copy and insert or replace a program section.....	59
9.6.3	Deleting a program section.....	60
9.7	Value entry for a program section.....	61
9.7.1	Section duration.....	61
9.7.2	Set-point ramp and set-point step.....	62
9.7.3	Special controller functions via operation lines.....	63
9.7.4	Setpoint entry.....	64
9.7.5	Tolerance range.....	65
9.7.6	Repeating one or several sections within a time program.....	66
9.7.7	Saving the time program.....	66
<b>10.</b>	<b>WEEK PROGRAMS .....</b>	<b>67</b>
10.1	Starting an existing week program.....	67
10.2	Cancelling a running week program .....	67
10.3	Creating a new week program .....	68
10.4	Program editor: program management.....	69
10.4.1	Deleting a week program.....	70
10.5	Section editor: section management.....	71
10.5.1	Add a new program section .....	72
10.5.2	Copy and insert or replace a program section.....	72
10.5.3	Deleting a program section.....	73

10.6	Value entry for a program section.....	73
10.6.1	Set-point ramp and set-point step modes.....	73
10.6.2	Weekday.....	74
10.6.3	Start time.....	74
10.6.4	Setpoint entry.....	75
10.6.5	Special controller functions via operation lines.....	75
<b>11.</b>	<b>NOTIFICATION AND ALARM FUNCTIONS.....</b>	<b>76</b>
11.1	Notification and alarm messages overview.....	76
11.1.1	Notifications.....	76
11.1.2	Alarm messages.....	77
11.1.3	Messages concerning the humidity system.....	77
11.2	State of alarm.....	79
11.3	Resetting an alarm, list of active alarms.....	79
11.4	Activating / deactivating the audible alarm (alarm buzzer).....	80
<b>12.</b>	<b>TEMPERATURE SAFETY DEVICES.....</b>	<b>80</b>
12.1	Over temperature protective device (class 1).....	80
12.2	Safety controller (over temperature safety device class 2).....	80
12.2.1	Safety controller modes.....	81
12.2.2	Setting the safety controller.....	81
12.2.3	Message and measures in the state of alarm.....	82
12.2.4	Function check.....	82
12.3	Over/under temperature safety device class 2 (option).....	83
<b>13.</b>	<b>USER MANAGEMENT.....</b>	<b>84</b>
13.1	Authorization levels and password protection.....	84
13.2	Log in.....	87
13.3	Log out.....	88
13.4	User change.....	88
13.5	Password assignment and password change.....	89
13.5.1	Password change.....	89
13.5.2	Deleting the password for an individual authorization level.....	91
13.5.3	New password assignment for "service" or "admin" authorization level when the password function was deactivated.....	92
13.6	Activation code.....	93
<b>14.</b>	<b>GENERAL CONTROLLER SETTINGS.....</b>	<b>94</b>
14.1	Selecting the controller's menu language.....	94
14.2	Setting date and time.....	94
14.3	Selecting the temperature unit.....	96
14.4	Display configuration.....	96
14.4.1	Adapting the display parameters.....	96
14.4.2	Touchscreen calibration.....	97
14.5	Network and communication.....	98
14.5.1	Serial interfaces.....	98
14.5.2	Ethernet.....	99
14.5.3	Web server.....	100
14.5.4	E-Mail.....	101
14.6	USB menu: Data transfer via USB interface.....	102
14.7	Turning off the interior lighting automatically.....	103
<b>15.</b>	<b>GENERAL INFORMATION.....</b>	<b>103</b>
15.1	Service contact page.....	103
15.2	Current operating parameters.....	104
15.3	Event list.....	105
15.4	Technical chamber information.....	105
15.5	Self-test function.....	106



<b>16. CHART RECORDER DISPLAY .....</b>	<b>108</b>
16.1 Views.....	108
16.1.1 Show and hide legend .....	108
16.1.2 Switch between legend pages .....	108
16.1.3 Show and hide specific indications .....	109
16.1.4 History display.....	109
16.2 Setting the parameters.....	112
<b>17. HUMIDIFICATION / DEHUMIDIFICATION SYSTEM.....</b>	<b>113</b>
17.1 Function of the humidifying and dehumidifying system .....	114
17.1.1 Freshwater .....	115
17.1.2 Wastewater .....	116
<b>18. DEFROSTING AT REFRIGERATING OPERATION.....</b>	<b>116</b>
<b>19. ANTI-CONDENSATION PROTECTION VIA OPERATION LINE.....</b>	<b>117</b>
<b>20. ZERO-VOLTAGE SWITCHING OUTPUTS VIA OPERATION LINES .....</b>	<b>118</b>
<b>21. OPTIONS.....</b>	<b>119</b>
21.1 Communication software APT-COM™ 3 DataControlSystem (option).....	119
21.2 RS485 interface (option) .....	119
21.3 Data logger kits (option).....	119
21.4 Analog outputs for temperature and humidity (option).....	120
21.5 Compressed air connection (option) .....	121
21.6 Controlled compressed air dryer (option).....	121
21.7 Water cooling (option).....	123
21.8 Object temperature display with flexible Pt 100 temperature sensor (option) .....	123
21.9 External freshwater and wastewater cans (option for MKF 56) .....	124
21.9.1 Connecting the freshwater can and the pump.....	124
21.9.2 Connecting the wastewater can.....	125
21.9.3 Connecting with wastewater recycling.....	126
21.10 BINDER Pure Aqua Service (option) .....	127
<b>22. MAINTENANCE, CLEANING, AND SERVICE .....</b>	<b>127</b>
22.1 Maintenance intervals, service.....	127
22.2 Cleaning and decontamination .....	128
22.2.1 Cleaning.....	128
22.2.2 Decontamination.....	130
22.3 Sending the chamber back to BINDER GmbH .....	131
<b>23. DISPOSAL .....</b>	<b>132</b>
23.1 Disposal of the transport packing.....	132
23.2 Decommissioning.....	132
23.3 Disposal of the chamber in the Federal Republic of Germany .....	132
23.4 Disposal of the chamber in the member states of the EU except for the Federal Republic of Germany.....	134
23.5 Disposal of the chamber in non-member states of the EU .....	135
<b>24. TROUBLESHOOTING .....</b>	<b>136</b>
<b>25. TECHNICAL DESCRIPTION.....</b>	<b>139</b>
25.1 Factory calibration and adjustment .....	139
25.2 Over current protection .....	139
25.3 Definition of usable volume .....	139
25.4 MKF (E4) technical data.....	140
25.5 MKFT (E4) technical data .....	142
25.6 Equipment and options (extract) .....	144
25.7 Accessories and spare parts (extract) .....	146
25.8 MKF heating-up and cooling-down graphs .....	147
25.9 MKFT heating-up and cooling-down graphs.....	148

---



25.10 MKF heat compensation graphs .....	149
25.11 MKFT heat compensation graphs .....	150
25.12 Dimensions .....	151
<b>26. CERTIFICATES AND DECLARATIONS OF CONFORMITY .....</b>	<b>156</b>
26.1 EU Declaration of Conformity for MKF .....	156
26.2 EU Declaration of Conformity for MKFT .....	159
26.3 Certificate for the GS mark of conformity of the "Deutsche Gesetzliche Unfallversicherung e.V." (German Social Accident Insurance) DGUV .....	162
<b>27. PRODUCT REGISTRATION .....</b>	<b>164</b>
<b>28. CONTAMINATION CLEARANCE CERTIFICATE .....</b>	<b>165</b>
28.1 For chambers located outside the USA and Canada .....	165
28.2 For chambers located in the USA and Canada .....	168

Dear customer,

For the correct operation of the chamber, it is important that you read this operating manual completely and carefully and observe all instructions as indicated. Failure to read, understand and follow the instructions may result in personal injury. It can also lead to damage to the chamber and/or poor equipment performance.

## 1. Safety

This operating manual is part of the components of delivery. Always keep it handy for reference. The device should only be operated by laboratory personnel especially trained for this purpose and familiar with all precautionary measures required for working in a laboratory. Observe the national regulations on minimum age of laboratory personnel. To avoid injuries and damage observe the safety instructions of the operating manual.

	 <b>WARNING</b>
	<p><b>Failure to observe the safety instructions. Serious injuries and chamber damage.</b></p> <ul style="list-style-type: none"> <li>➤ Observe the safety instructions in this operating manual.</li> <li>➤ Carefully read the complete operating instructions of the chamber.</li> </ul>

### 1.1 Legal considerations

This operating manual is for informational purposes only. It contains information for installing, start-up, operation and maintenance of the product. Note: the contents and the product described are subject to change without notice.

Understanding and observing the instructions in this operating manual are prerequisites for hazard-free use and safety during operation and maintenance. In no event shall BINDER be held liable for any damages, direct or incidental arising out of or related to the use of this manual.

This operating manual cannot cover all conceivable applications. If you would like additional information, or if special problems arise that are not sufficiently addressed in this manual, please ask your dealer or contact us directly by phone at the number located on page one of this manual

Furthermore, we emphasize that the contents of this operating manual are not part of an earlier or existing agreement, description, or legal relationship, nor do they modify such a relationship. All obligations on the part of BINDER derive from the respective purchase contract, which also contains the entire and exclusively valid statement of warranty administration. The statements in this manual neither augment nor restrict the contractual warranty provisions.

### 1.2 Structure of the safety instructions

In this operating manual, the following safety definitions and symbols indicate dangerous situations following the harmonization of ISO 3864-2 and ANSI Z535.6.

#### 1.2.1 Signal word panel

Depending on the probability of serious consequences, potential dangers are identified with a signal word, the corresponding safety color, and if appropriate, the safety alert symbol.

 <b>DANGER</b>
<p>Indicates an imminently hazardous situation that, if not avoided, will result in death or serious (irreversible) injury.</p>

**WARNING**

Indicates a potentially hazardous situation which, if not avoided, could result in death or serious (irreversible) injury

**CAUTION**

Indicates a potentially hazardous situation which, if not avoided, may result in moderate or minor (reversible) injury

**CAUTION**

Indicates a potentially hazardous situation which, if not avoided, may result in damage to the product and/or its functions or of a property in its proximity.

### 1.2.2 Safety alert symbol



Use of the safety alert symbol indicates a **risk of injury**.

Observe all measures that are marked with the safety alert symbol in order to avoid death or injury.

### 1.2.3 Pictograms

Warning signs			
Electrical hazard	Hot surface	Explosive atmosphere	Stability hazard
Lifting hazard	High humidity	Scalding hazard	Pollution hazard
Harmful substances	Biohazard	Danger of frost	Risk of corrosion and / or chemical burns
Mandatory action signs			
Mandatory regulation	Read operating instructions	Disconnect the power plug	Lift with mechanical assistance
Environment protection	Wear protective gloves	Wear safety goggles	

Prohibition signs			
Do NOT touch	Do NOT spray with water	Do NOT climb	

	<b>Information</b> to be observed in order to ensure optimum function of the product.
--	---

### 1.2.4 Word message panel structure

<p><b>Type / cause of hazard.</b></p> <p><b>Possible consequences.</b></p> <ul style="list-style-type: none"> <li>∅ Instruction how to avoid the hazard: prohibition</li> <li>➤ Instruction how to avoid the hazard: mandatory action</li> </ul>
--

Observe all other notes and information not necessarily emphasized in the same way, in order to avoid disruptions that could result in direct or indirect injury or property damage.

### 1.3 Localization / position of safety labels on the chamber

The following labels are located on the chamber:

Pictograms (warning signs)	
	Hot surface (on chamber door)      Cold surface (on chamber door)
	Electrical hazard (chamber with voltage and frequency changer: on the voltage and frequency changer)
	Observe the prescribed freshwater quality (next to water inlet on the rear of the chamber; on the optional freshwater can)
	Burning and scalding hazard (chamber rear)
Service label	
<div style="background-color: #ff0000; color: white; padding: 10px;"> <p><b>Service - Hotline</b></p> <p>International: + 49 (0) 7462 / 2005-555            USA Toll Free: + 1 866 885 9794            or: + 1 631 224 4340            Россия и СНГ: + 7 495 98815 17</p> <p>serv.ce@binder-world.com      </p> <p>www.binder-world.com</p> </div>	

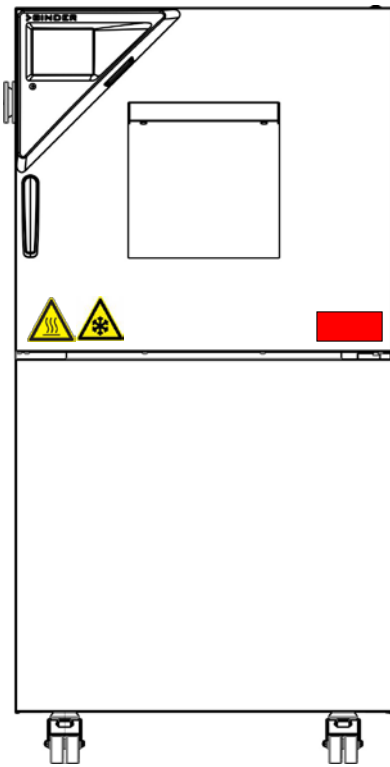

Example: MKF 56

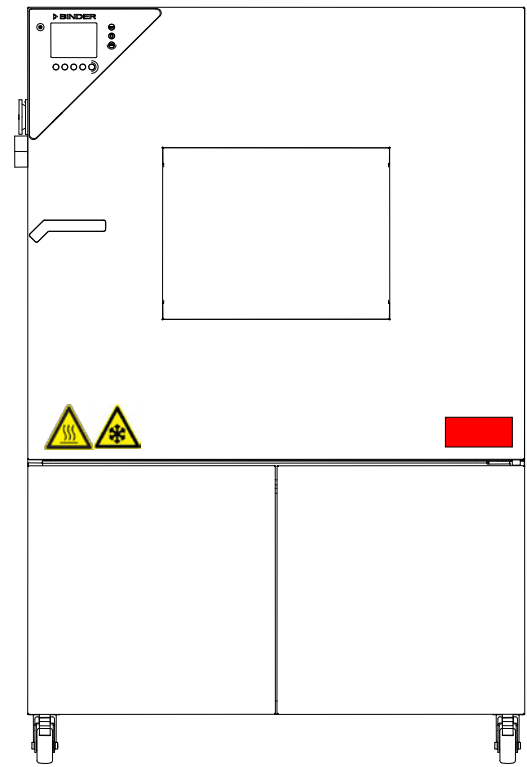

Example: MKF 240

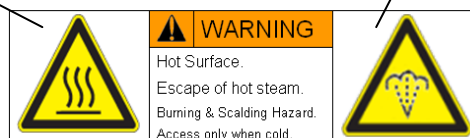
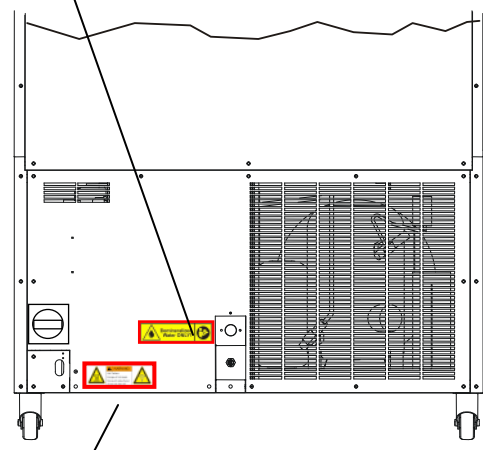
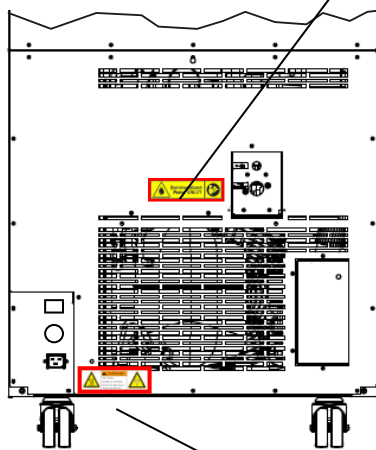

Figure 1: Position of labels on the chamber



Keep safety labels complete and legible.

Replace safety labels that are no longer legible. Contact BINDER service for these replacements.



## 1.4 Type plate

The type plate sticks to the left side of the chamber, bottom right-hand, above the refrigerating and humidity module.

Nominal temp.	180 °C 356 °F	6,50 kW / 12,0 A 400 V / 50 Hz	   	Max. operating pressure 29 bar Stage 1: R 404 A – 2,20 kg Stage 2: R 23 - 0,40 kg Contains fluorinated greenhouse gases covered by the Kyoto Protocol
IP protection	20			
Safety device	DIN 12880	3 N ~		
Class	2.0			
Art. No.	9020-0212			
Project No.				
Built	2018	Alternating climate chamber		
		BINDER GmbH Im Mittleren Ösch 5 78532 Tuttlingen / Germany www.binder-world.com	<b>MKFT 240</b> <b>E4</b>	 <b>Serial No. 00000000000000</b> Made in Germany

Figure 2: Type plate (example of MKFT 240 regular unit)

Indications of the type plate (example)		Information
BINDER		Manufacturer: BINDER GmbH
MKF 56		Model designation
Alternating climate chamber		Device name
Serial No.	0000000000000000	Serial no. of the chamber
Built	2018	Year of construction
Nominal temperature	180 °C 356 °F	Nominal temperature
IP protection	20	IP type of protection acc. to standard EN 60529
Temp. safety device	DIN 12880	Temperature safety device acc. to standard DIN 12880
Class	2.0	Class of temperature safety device
Art. No.	9020-0212	Art. no. of the chamber
Project No.	---	Optional: Special application acc. to project no.
6,50 kW		Nominal power
12,0 A		Nominal current
400 V / 50 Hz		Nominal voltage +/- 10% at the indicated power frequency
3 N ~		Current type
Max operating pressure 29 bar		Max operating pressure in the refrigerating system
Stage 1: R 404A - 2,20 kg		Cooling 1 <sup>st</sup> stage: Refrigerant type, filling weight
Stage 2: R 23 – 0,40 kg		Cooling 2 <sup>nd</sup> stage: Refrigerant type, filling weight
Contains fluorinated greenhouse gases covered by the Kyoto Protocol		

Symbol on the type plate	Information
	CE conformity marking
	Electrical and electronic equipment manufactured / placed on the market in the EU after 13 August 2005 and be disposed of in separate collection according to the Directive 2012/19/EU on waste electrical and electronic equipment (WEEE).
	GS mark of conformity of the "Deutsche Gesetzliche Unfallversicherung e.V. (DGUV), Prüf- und Zertifizierungsstelle Nahrungsmittel und Verpackung im DGUV Test" (German Social Accident Insurance (DGUV), Testing and Certification Body for Foodstuffs and Packaging Industry in DGUV Test).



Symbol on the type plate	Information
	<b>MKF/MKFT 115/240/720:</b> The chamber is certified according to Customs Union Technical Regulation (CU TR) for the Eurasian Economic Union (Russia, Belarus, Armenia, Kazakhstan Kyrgyzstan).

## 1.5 General safety instructions on installing and operating the chamber



With regard to operating the chamber and to the installation location, please observe the DGUV guidelines 213-850 on safe working in laboratories (formerly BGI/GUV-I 850-0, BGR/GUV-R 120 or ZH 1/119, issued by the employers' liability insurance association) (for Germany).

BINDER GmbH is only responsible for the safety features of the chamber provided skilled electricians or qualified personnel authorized by BINDER perform all maintenance and repair, and if components relating to chamber safety are replaced in the event of failure with original spare parts.



To operate the chamber, use only original BINDER accessories or accessories from third-party suppliers authorized by BINDER. The user is responsible for any risk caused by using unauthorized accessories.

	<b>CAUTION</b>
	<p><b>Danger of overheating.</b> <b>Damage to the chamber.</b></p> <ul style="list-style-type: none"> <li>⊘ Do NOT install the chamber in unventilated recesses.</li> <li>➤ Ensure sufficient ventilation for dispersal of the heat.</li> </ul>

Do not operate the chamber in hazardous locations.



	 <b>DANGER</b>
	<p><b>Explosion hazard.</b> <b>Danger of death.</b></p> <ul style="list-style-type: none"> <li>⊘ Do NOT operate the chamber in potentially explosive areas.</li> <li>⊘ KEEP explosive dust or air-solvent mixtures AWAY from the chamber.</li> </ul>

The alternating chamber does not dispose of any measures of explosion protection.



	 <b>DANGER</b>
	<p><b>Explosion hazard.</b> <b>Danger of death.</b></p> <ul style="list-style-type: none"> <li>⊘ Do NOT introduce any substance combustible or explosive at working temperature into the alternating climate chamber.</li> <li>⊘ NO explosive dust or air-solvent mixture in the inner chamber.</li> </ul>



Any solvent contained in the charging material must not be explosive or inflammable. I.e., irrespective of the solvent concentration in the steam room, NO explosive mixture with air must form. The temperature inside the chamber must lie below the flash point or below the sublimation point of the charging material. Familiarize yourself with the physical and chemical properties of the charging material, as well as the contained moisture constituent and its behavior with the addition of heat energy and humidity.

Familiarize yourself with any potential health risks caused by the charging material, a possibly contained moisture constituent or by reaction products that may arise during the conditioning process. Take adequate measures to exclude such risks prior to putting the chamber into operation.

	 <b>DANGER</b>
	<p><b>Electrical hazard.</b> <b>Danger of death.</b></p> <ul style="list-style-type: none"> <li>∅ The chamber must NOT become wet during operation or maintenance.</li> </ul>

The chambers were produced in accordance with VDE regulations and were routinely tested in accordance to VDE 0411-1 (IEC 61010-1).

	 <b>CAUTION</b>
	<p><b>The window, the access ports and the inner chamber will become hot during operation.</b></p> <p><b>Danger of burning.</b></p> <ul style="list-style-type: none"> <li>∅ Do NOT touch the window, the access ports, the inner surfaces or the charging material during operation.</li> </ul>

 	 <b>WARNING</b>
	<p><b>Stability hazard.</b> <b>Danger of injury.</b> <b>Damage to the chamber and the charging material.</b> <b>Housing cover breakaway.</b></p> <ul style="list-style-type: none"> <li>∅ Do NOT climb on the lower housing cover.</li> <li>∅ Do NOT load the lower housing cover with heavy objects while the chamber door is open.</li> </ul>

## 1.6 Intended use

Alternating climate chambers series MKF / MKFT are suitable for temperature drying and heat treatment of solid or pulverized charging material, as well as bulk material, using the supply of heat. They are suitable for harmless materials. A mixture of any component of the charging material with air must NOT be explosive. The operating temperature must lie below the flash point or below the sublimation point of the charging material. Any component of the charging material must NOT be able to release toxic gases.

### Other applications are not approved.



The chambers are specially designed for solving all the problems which occur during material and ageing tests.

**The chambers are not classified as medical devices as defined by the Medical Device Directive 93/42/EEC.**

	Due to the special demands of the Medical Device Directive (MDD), these ovens are not qualified for sterilization of medical devices as defined by the directive 93/42/EEG.
---	---

	Following the instructions in this operating manual and conducting regular maintenance work (chap. 21.10) is part of the intended use.
---	--

The chambers do not dispose of any measures of explosion protection.

 	 <b>DANGER</b>
	<p><b>Explosion or implosion hazard.</b>  <b>Danger of poisoning.</b>  <b>Danger of death.</b></p> <ul style="list-style-type: none"> <li>⊘ Do NOT introduce any substance combustible or explosive at working temperature into the chamber, in particular no energy sources such as batteries or lithium-ion batteries</li> <li>⊘ NO explosive dust or air-solvent mixture in the inner chamber.</li> <li>⊘ Do NOT introduce any substance which could lead to release of toxic gases.</li> </ul>

	The charging material shall not contain any corrosive ingredients that may damage the machine components made of stainless steel, aluminum, and copper. Such ingredients include in particular acids and halides. Any corrosive damage caused by such ingredients is excluded from liability by BINDER GmbH.
---	--

In case of foreseeable use of the chamber there is no risk for the user through the integration of the chamber into systems or by special environmental or operating conditions in the sense of EN 61010-1:2010. For this, the intended use of the chamber and all its connections must be observed.

## 1.7 Operating instructions

Depending on the application and location of the chamber, the operator of the chamber must provide the relevant information for safe operation of the chamber in a set of operating instructions.

	Keep these operating instructions with the chamber at all times in a place where they are clearly visible. They must be comprehensible and written in the language of the employees.
---	--

## 1.8 Measures to prevent accidents

The operator of the chamber must observe the following rule: "Betreiben von Arbeitsmitteln. Betreiben von Kälteanlagen, Wärmepumpen und Kühleinrichtungen" (Operation of work equipment. Operation of refrigeration systems, heat pumps and refrigeration equipment) (GUV-R 500 chap. 2.35) (for Germany).

The manufacturer took the following measures to prevent ignition and explosions:

- **Indications on the type plate**

See operating manual chap. 1.4.

- **Operating manual**

An operating manual is available for each chamber.

- **Overtemperature monitoring**

The chamber is equipped with a temperature display, which can be read from outside.

The chamber is equipped with an additional safety controller (temperature safety device class 2 acc. to DIN 12880:2007). Visual and audible (buzzer) signals indicate temperature exceeding.

- **Safety, measurement, and control equipment**

The safety, measuring, and control equipment is easily accessible.

- **Electrostatic charge**

The interior parts are grounded.

- **Non-ionizing radiation**

Non-ionizing radiation is not intentionally produced, but released only for technical reasons by electrical equipment (e.g. electric motors, power cables, solenoids). The machine has no permanent magnets. If persons with active implants (e.g. pacemakers, defibrillators) keep a safe distance (distance of field source to implant) of 30 cm, an influence of these implants can be excluded with high probability.

- **Protection against touchable surfaces**

Tested according to EN ISO 13732-1:2008.

- **Floors**

See operating manual chap. 3.4 for correct installation

- **Cleaning**

See operating manual chap. 22.2.

- **Examinations**

The chamber has been inspected by the "Deutsche Gesetzliche Unfallversicherung e.V. (DGUV) (German Social Accident Insurance (DGUV))" (German Social Accident Insurance (DGUV), Testing and Certification Body for Foodstuffs and Packaging Industry in DGUV Test) and bears the GS mark.

## 1.9 Resistance of the humidity sensor against harmful substances

The following list of harmful substances refers only to the humidity sensor and does not include any other materials incorporated in the chamber or prohibited substances in relation to explosion protection.

Some gases - especially clean gases - do not have any influence on the humidity sensor. Others do have a very small influence, whereas others may influence the sensor to a larger extent.

- The following gases do not influence the sensor and the humidity measurement: Argon (Ar), carbon dioxide (CO<sub>2</sub>), helium (He), hydrogen (H<sub>2</sub>), neon (Ne), nitrogen (N<sub>2</sub>), nitrous oxide (N<sub>2</sub>O), oxygen (O<sub>2</sub>)
- The following gases do not, or to a minor extent influence the sensor and the humidity measurement: Butane (C<sub>4</sub>H<sub>10</sub>), ethane (C<sub>2</sub>H<sub>6</sub>), methane (CH<sub>4</sub>), natural gas propane (C<sub>3</sub>H<sub>8</sub>)
- The following gases do not, or to a minor extent influence the sensor and the humidity measurement, provided that the indicated loads are not exceeded:

		Maximum work place threshold limit value		Tolerated concentration with permanent load	
Substance	Formula	ppm	mg/m <sup>3</sup>	ppm	mg/m <sup>3</sup>
Ammonia	NH <sub>3</sub>	20	14	5500	4000
Acetone	CH <sub>3</sub> COCH <sub>3</sub>	500	1200	3300	8000
Benzene		300	1200		150000
Chlorine	Cl <sub>2</sub>	0.5	1.5	0.7	2
Acetic acid	CH <sub>3</sub> COOH	10	25	800	2000
Ethyl acetate	CH <sub>3</sub> COOC <sub>2</sub> H <sub>5</sub>	400	1400	4000	15000
Ethanol	C <sub>2</sub> H <sub>5</sub> OH	500	960	3500	6000
Ethylene glycol	HOCH <sub>2</sub> CH <sub>2</sub> OH	10	26	1200	3000
Formaldehyde	HCHO	0.3	0.37	2400	3000
Isopropanol	(CH <sub>3</sub> ) <sub>2</sub> CHOH	200	500	4800	12000
Methanol	CH <sub>3</sub> OH	200	260	3500	6000
Methyl ethyl ketone	C <sub>2</sub> H <sub>5</sub> COCH <sub>3</sub>	200	590	3300	8000
Ozone	O <sub>3</sub>	0.1	0.2	0.5	1
Hydrochloric acid	HCl	2	3	300	500
Hydrogen sulphide	H <sub>2</sub> S	10	15	350	500
Nitrogen oxides	NO <sub>x</sub>	5	9	5	9
Sulphur dioxide	SO <sub>2</sub>	5	13	5	13
Toluol	C <sub>6</sub> H <sub>5</sub> CH <sub>3</sub>	100	380	1300	5000
Xylene	C <sub>6</sub> H <sub>4</sub> (CH <sub>3</sub> ) <sub>2</sub>	100	440	1300	5000

These values are to be considered only as approximate values. The sensor resistance largely depends on the temperature and humidity conditions during the time of exposure to harmful substances. Avoid simultaneous condensation. Tolerated error of measurement: ± 2 % r.H. The maximum work place threshold limit value is the one that can be regarded as harmless for humans.

- Vapors of oil and fat are dangerous for the sensor because they may condensate at the sensor and thus prevent its function (insulating layer). For similar reasons it is not possible to measure smoke gases.

## 2. Chamber description

The alternating climate chamber MKF / MKFT is a specially developed precision cooling/warming cabinet for the domain of industrial material testing and environment simulation, with an unrivalled capacity, which far exceeds the capabilities of normal test cabinets, providing the ideal facilities for solving all the problems which occur during material as well as ageing and stress tests.

The chambers are equipped with a multifunctional microprocessor display controller with 2-channel technology for temperature and humidity plus a digital display accurate to one-tenth of a degree resp. 0.1% r.H. With its comprehensive program control functions, the display program controller MB2 permits the high precision performance of temperature and humidity cycles with rapid heating up and cooling down phases.

With its microprocessor controlled humidifying and dehumidifying system the chamber is a high-precision climatic test chamber. It covers the regular test specifications for temperature and climates corresponding to DIN und IEC standards. Furthermore, it permits simulating exactly and over long periods constant conditions for other applications such as sample conditioning for material testing of paper, textiles, plastics, building materials, etc.

The patented APT.line™ preheating chamber and air conduction technology guarantees excellent spatial temperature and humidity values for the total working area. The chamber provides a powerful refrigerating system with rapid cooling-down speeds. In addition, the chamber provides almost unlimited possibilities for adaptation to individual customer requirements based upon extensive programming options.

A resistance humidifying system humidifies the air. For this purpose, use deionized (demineralized) water. The option BINDER Pure Aqua Service permits using the chamber with any degree of water hardness.

The high-quality housing insulation guarantees both a low noise mode of operation and a consistently low housing temperature. The inner chamber, the pre-heating chamber and the interior side of the doors are all made of stainless steel V2A (German material no. 1.4301, US equivalent AISI 304). When operating the chamber at temperatures above 150 °C / 302 °F, the impact of the oxygen in the air may cause discoloration of the metallic surfaces (yellowish-brown or blue) by natural oxidation processes. These colorations are harmless and will in no way impair the function or quality of the chamber. The housing is RAL 7035 powder-coated. All corners and edges are completely coated.

The efficient program controller is equipped with a multitude of operating functions, in addition to recorder and alarm functions. Programming of test cycles is easily accomplished via the modern touchscreen controller MB2 and is also possible directly with a computer via Intranet in connection with the communication software APT-COM™ 3 DataControlSystem (option, chap. 21.1). The chamber comes equipped with an Ethernet serial interface for computer communication. In addition, the BINDER communication software APT-COM (option) permits networking up to 30 chambers and connecting them to a PC for controlling and programming, as well as recording and representing temperature and humidity data. For further options, see chap. 25.6.

The chambers are equipped with four castors. Both front castors can be easily locked via the attached brakes.

Temperature ranges:

- MKF without humidity: -40 °C / 104 °F up to +180 °C / 356 °F,
- MKFT without humidity: -70 °C / -94 °F up to +180 °C / 356 °F,
- MKF / MKFT in climatic operation: + 10 °C / 50 °F up to +95 °C / 203 °F
- Chambers with optional compressed air dryer in climatic operation: 0 °C / 32 °F up to +95 °C / 203 °F

Humidity ranges:

- 10% up to 98% r.H.
- Chambers with optional compressed air dryer: 5 % r.H. up to 98 % r.H.

**2.1 Chamber overview**

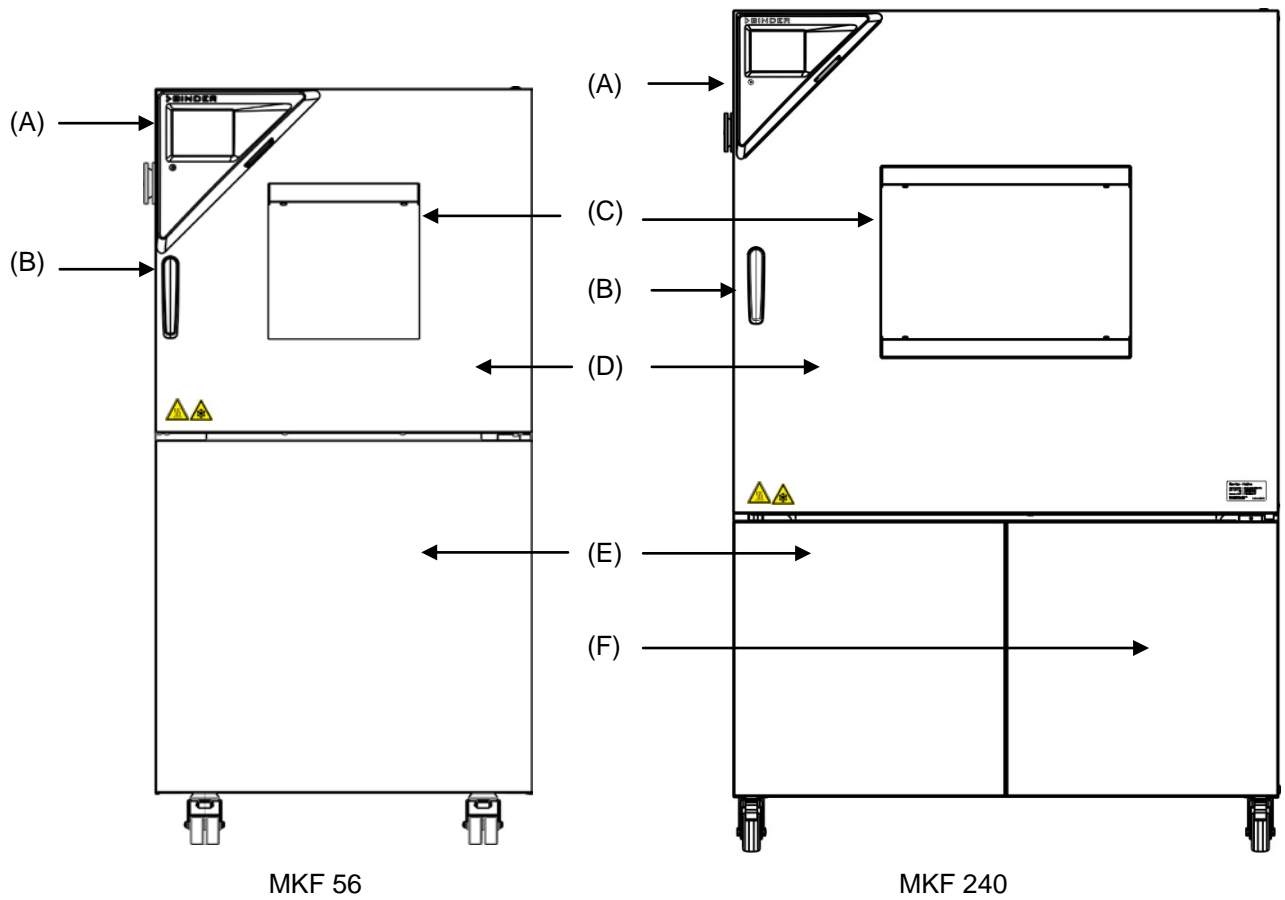

Figure 3: Alternating climate chambers MKF / MKFT

(A) Instrument panel	(D) Door
(B) Door handle	(E) Refrigeration / humidity module
(C) Window	(F) Access to fill the water can

**2.2 Instrument panel**

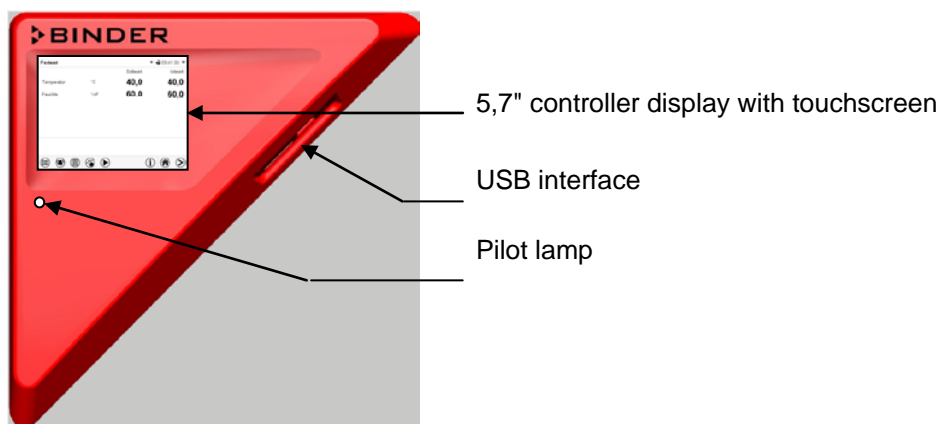

Figure 4: Instrument panel with MB2 program controller and USB interface



## 2.3 Lateral control panel

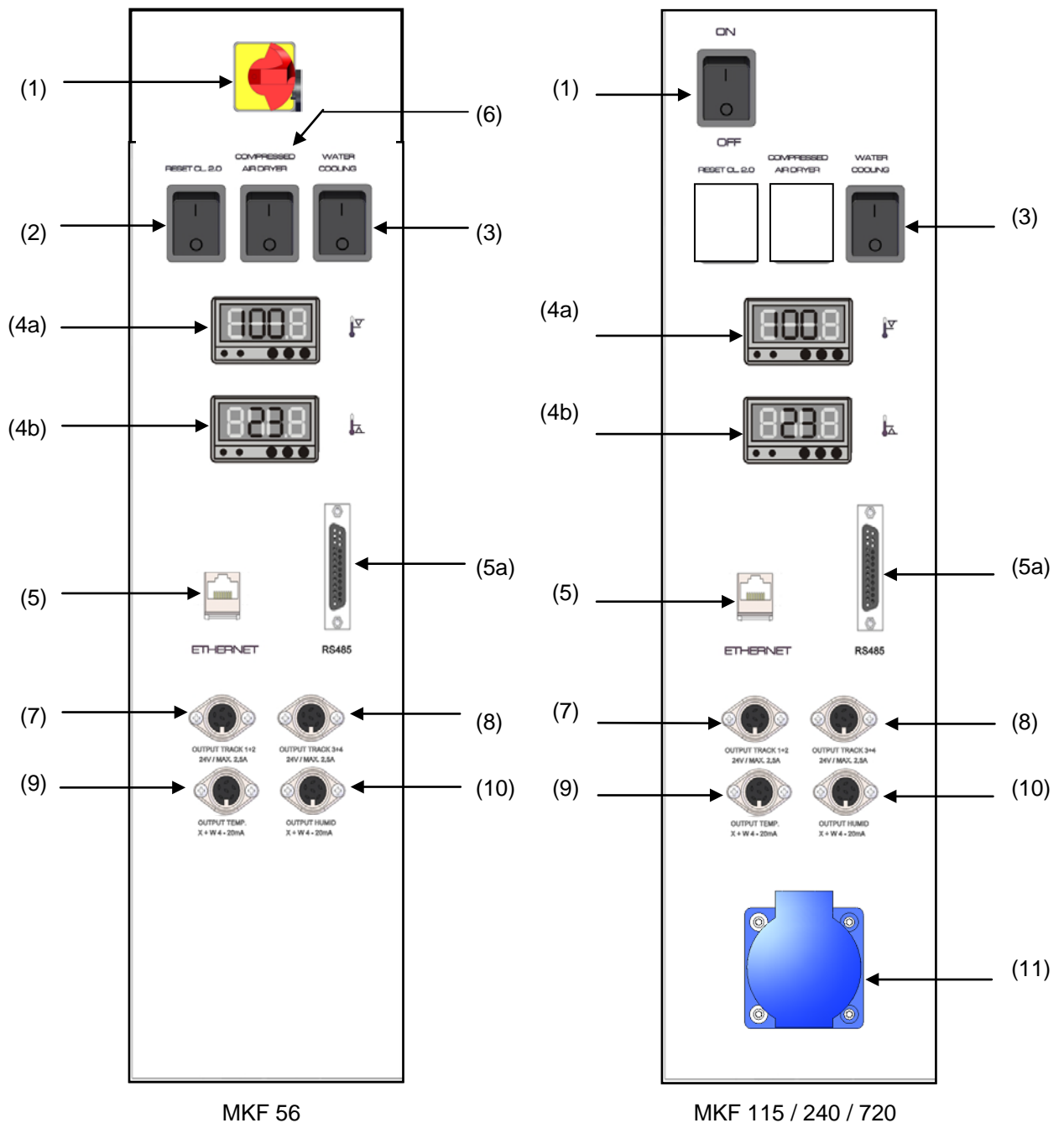

Figure 5: Lateral control panel at the right side of the humidity module with options

(1) Main power switch ON/OFF	(5a) RS485 interface for computer communication (option)
(2) Reset switch for over and under temperature safety device class 2 (option), MKF 56 only	(6) Switch for compressed air dryer (option), MKF 56 only
(3) Switch for water cooling (option)	(7) 2 zero-voltage relay outputs via operation lines
(4) Temperature safety device class 2 for over and under temperature (option): Entry displays for upper (4a) and lower (4b) temperature limit	(8) 2 zero-voltage relay outputs via operation lines
(5) Ethernet interface for computer communication	(9) Analog output for temperature (option)
	(10) Analog output for humidity (option)
	(11) Socket 230 V AC, max. 500 W (MKF/MKFT 115, 240, 720)

## 2.4 Main power switch (MKF 56)

This switch allows completely switching off the chamber (de-energized condition).



Figure 6: Main power switch (1) in the lateral control panel of MKF 56

## 2.5 Rear power switch (MKF / MKFT 115, 240, 720)

This switch allows completely switching off the chamber (de-energized condition).



Figure 7: Rear view MKF/MKFT 115, 240, 720

- |   |
|---|
| <p>(1) Main power switch On / Off</p> <p>(12) Rear power switch</p> |
|---|

## 2.6 Rear chamber view

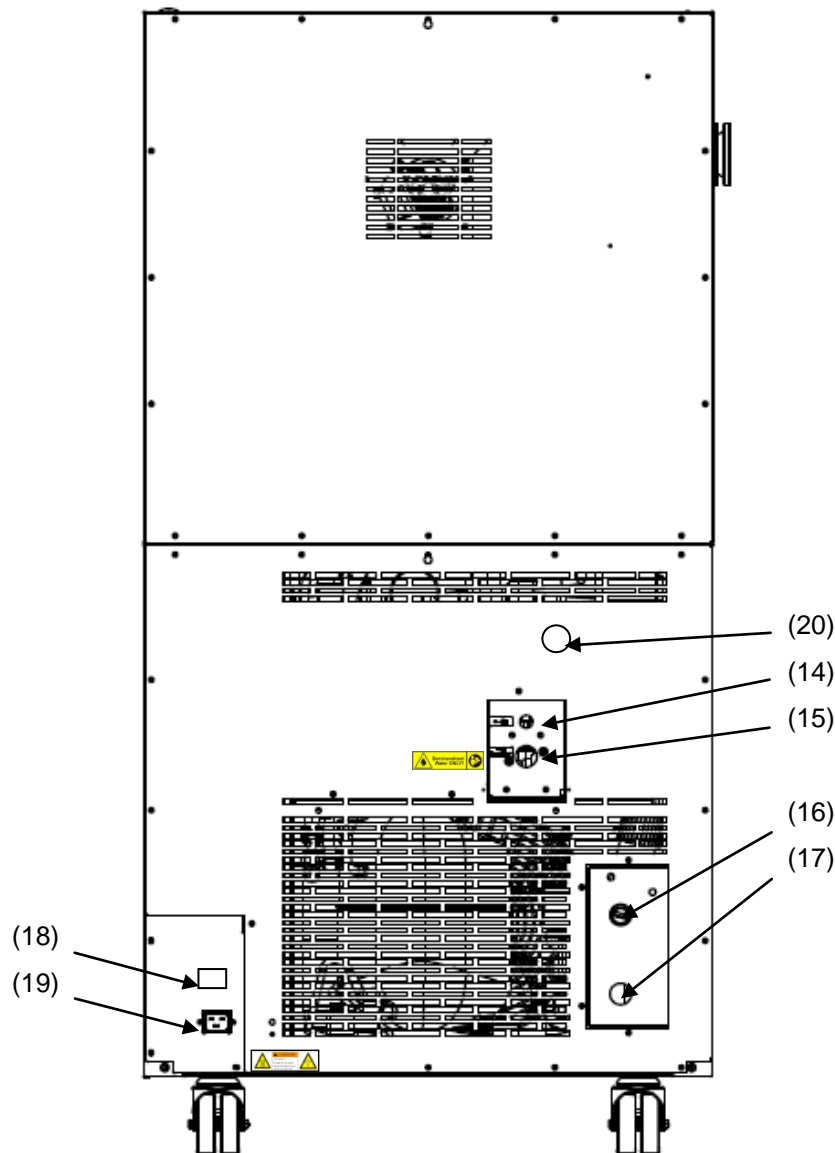

Figure 8: MKF 56 rear view with water connections and the options water cooling and compressed air connection

(14) Wastewater connection "OUT" with hose olive for hose 1/2"	(18) Socket for optional freshwater can (option for MKF 56, chap. 21.9)
(15) Freshwater connection "IN" with screw thread 3/4" for hose 1/2", with union nut	(19) IEC connector plug
(16) Connection "OUT" for cooling water outlet with screw thread 3/4" for hose 1/2", with union nut (water cooling option)	(20) Compressed air connection (option): Coupling connector to connect compressed air or the compressed air dryer (option)
(17) Connection "IN" for cooling water inlet with screw thread 3/4" for hose 1/2", with union nut (water cooling option)	

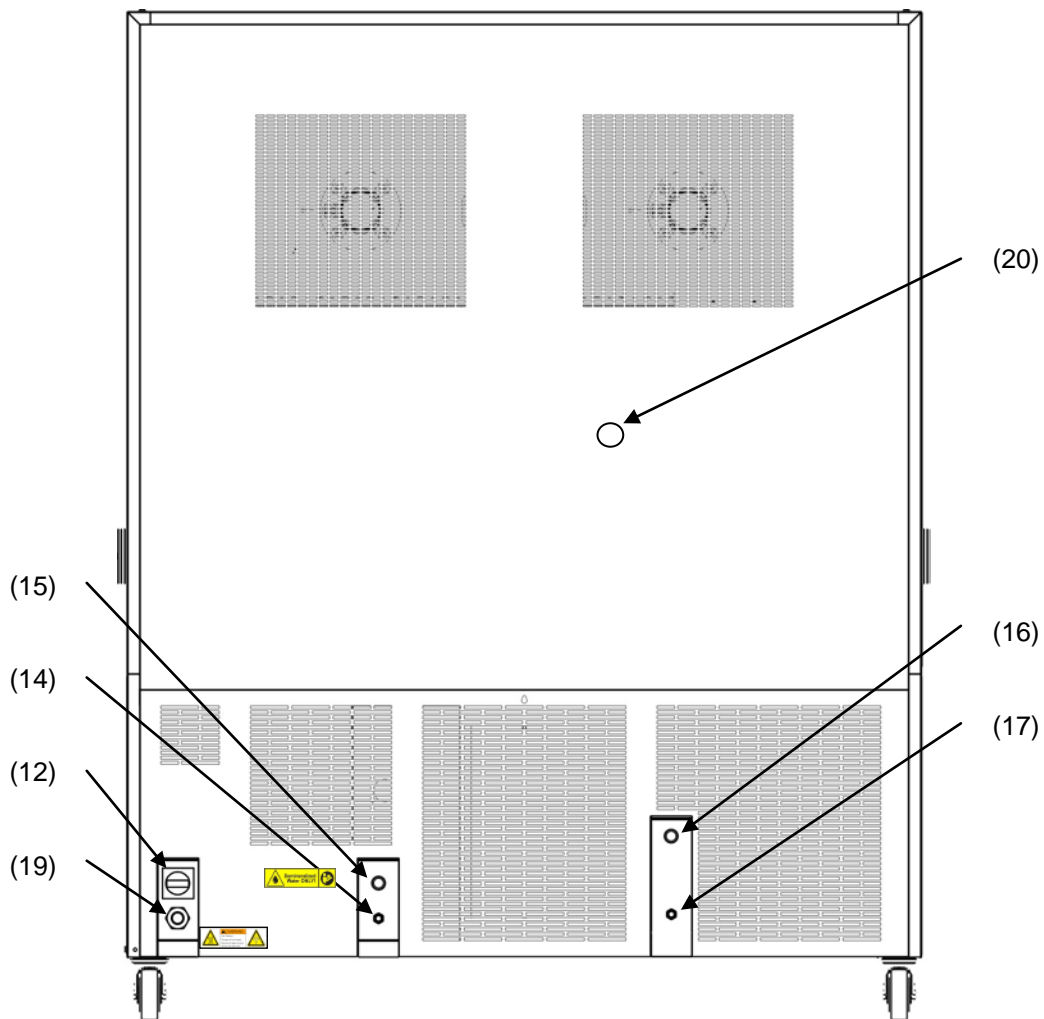

Figure 9: MKF/MKFT 115, 240, 720 rear view with water connections and the options water cooling and compressed air connection (example: MKF 720)

(12) Rear power switch	(17) Connection "IN" for cooling water inlet with screw thread $\frac{3}{4}$ " for hose $\frac{1}{2}$ ", with union nut (water cooling option)
(13) not used	(18) not used
(14) Wastewater connection "OUT" with hose olive for hose $\frac{1}{2}$ "	(19) Power connection
(15) Freshwater connection "IN" with screw thread $\frac{3}{4}$ " for hose $\frac{1}{2}$ ", with union nut	(20) Compressed air connection (option): Coupling connector to connect compressed air or the compressed air dryer (option)
(16) Connection "OUT" for cooling water outlet with screw thread $\frac{3}{4}$ " for hose $\frac{1}{2}$ ", with union nut (water cooling option)	

### 3. Completeness of delivery, transportation, storage, and installation

#### 3.1 Unpacking, and checking equipment and completeness of delivery

After unpacking, please check the chamber and its optional accessories, if any, based on the delivery receipt for completeness and for transportation damage. Inform the carrier immediately if transportation damage has occurred.





The final tests of the manufacturer may have caused traces of the shelves on the inner surfaces. This has no impact on the function and performance of the chamber.

Please remove any transportation protection devices and adhesives in/on the chamber and on the doors and take out the operating manuals and accessory equipment.

Remove the upholstered transport piece (L-type profile) from the lower door locking and keep it for possible later transportation.



Figure 10:  
Door locking with transport piece (state of delivery)

  	 <b>CAUTION</b>
<p><b>Sliding or tilting of the chamber.</b>  <b>Damage to the chamber.</b>  <b>Risk of injury by lifting heavy loads.</b></p> <ul style="list-style-type: none"> <li>⊘ Do NOT lift or transport the chamber using the door handle, the door or the lower housing.</li> <li>⊘ Do NOT lift the chamber by hand.</li> <li>➤ Keep the chamber in upright position.</li> <li>➤ Lift the chamber from the pallet using technical devices (fork lifter). Set the fork lifter only from the rear in the middle of the chamber. Make sure to place all the lateral supports of the chamber on the forks.</li> </ul>	

If you need to return the chamber, please use the original packing and observe the guidelines for safe lifting and transportation (chap. 3.2).

For disposal of the transport packing, see chap. 23.1.





#### **Note on second-hand units (Ex-Demo-Units)**

Second-hand units are chambers that have been used for a short time for tests or exhibitions. They are thoroughly tested before resale. BINDER ensures that the chamber is technically sound and will work flawlessly.

Second-hand units are marked with a sticker on the chamber door. Please remove the sticker before commissioning the chamber.

### 3.2 Guidelines for safe lifting and transportation

The front castors of the chamber can be blocked by brakes. Please move the chambers with castors only when empty and on an even surface, otherwise the castors may be damaged. Mount the upholstered steel L-type profile at the lower door locking. After operation please observe the guidelines for temporarily decommissioning the chamber (chap. 23.2).

  	 <b>CAUTION</b>
<p><b>Sliding or tilting of the chamber.</b>  <b>Damage to the chamber.</b>  <b>Risk of injury by lifting heavy loads.</b></p> <ul style="list-style-type: none"> <li>➤ Do NOT lift or transport the chamber using the door handle, the door or at the lower housing.</li> <li>➤ Do NOT lift the chamber by hand.</li> <li>➤ Transport the chamber only in its original packaging.</li> <li>➤ Secure the chamber with transport straps for transport.</li> <li>➤ Keep the chamber in upright position.</li> <li>➤ Place the chamber using technical devices (fork lifter) on the transport pallet. Set the fork lifter only from the rear in the middle of the chamber. Make sure to place all the lateral supports of the chamber on the forks.</li> <li>➤ Transport the chamber with the original transport pallet. Set the fork lifter ONLY to the pallet. Without the pallet the chamber is in imminent danger of overturning.</li> </ul>	

You can order transport packing and pallets for transportation purposes from BINDER service.

**Permissible ambient temperature range during transport:**

- If the steam humidifying system has NOT been emptied: +3 °C / 37.4 °F to +60 °C / 140 °F.
- After BINDER Service has emptied the steam humidifying system: -10 °C / 14 °F to +60 °C / 140 °F.

With temperatures below +3 °C / 37.4°F, water must be completely removed from the humidifying system.

	<b>CAUTION</b>
<p><b>Transport below +3 °C / 37.4 °F with filled steam humidifying system.</b>  <b>Freezing in the steam generator.</b>  <b>Damage to the chamber.</b></p> <ul style="list-style-type: none"> <li>➤ Contact BINDER Service before any transportation below +3 °C / 37.4 °F.</li> </ul>	

### 3.3 Storage

Intermediate storage of the chamber is possible in a closed and dry room. Observe the guidelines for temporary decommissioning (chap. 23.2).

**Permissible ambient temperature range during storage:**

- If the steam humidifying system has NOT been emptied: +3 °C / 37.4 °F to +60 °C / 140 °F.
- After BINDER Service has emptied the steam humidifying system: -10 °C / 14 °F to +60 °C / 140 °F.

With temperatures below +3 °C / 37.4 °F, water must be completely removed from the humidifying system.

	<b>CAUTION</b>
	<p><b>Storage below +3 °C / 37.4 °F with filled steam humidifying system.</b>  <b>Freezing in the steam generator.</b>  <b>Damage to the chamber.</b></p> <p>➤ Contact BINDER Service before any storage below +3 °C / 37.4 °F.</p>

- **Permissible ambient humidity:** max. 70 % r.H., non-condensing

	<b>CAUTION</b>
	<p><b>Condensation by excess humidity.</b>  <b>Danger of corrosion on the housing after operating at humidity values &gt; 70 % r.H. for a long period.</b></p> <p>➤ Dry the appliance completely before shut-down:</p> <ul style="list-style-type: none"> <li>• Set the humidity to 0 % r.H. To enable dehumidification, the humidifying and dehumidifying system must be activated (deactivated operation line "Humidity off", chap. 7.3 and setting "Control on", chap. 6.3).</li> <li>• Set the temperature set point to 60 °C / 140 °F (Manual mode). Let the chamber operate for approx. 2 hours with closed door. Remove the access port plugs.</li> <li>• Only then, shut down the chamber at the main power switch (1) and close the tap of the water supply.</li> </ul>

	<p>After drying the chamber for decommissioning, the humidity value will approximate ambient humidity.</p>
---	--

When after storage in a cold location you transfer the chamber to its warmer installation site, condensation may form. Before start-up, wait at least two hours until the chamber has attained ambient temperature and is completely dry and the oil in the compressors has warmed up.

In case of a prolonged temporal decommissioning: Leave the chamber door open or remove the access port plugs.

### 3.4 Location of installation and ambient conditions

Set up the chamber on a flat, even and non-flammable surface, free from vibration, and in a well-ventilated, dry location and align it using a spirit level. The site of installation must be capable of supporting the chamber's weight (see technical data, chap. 25.4). The chambers are designed for setting up inside a building (indoor use).

When after storage in a cold location you transfer the chamber to its warmer installation site, condensation may form. Before start-up, wait at least two hours until the chamber has attained ambient temperature and is completely dry and the oil in the compressors has warmed up.

	<b>CAUTION</b>
	<p><b>Danger of overheating.</b>  <b>Damage to the chamber.</b></p> <p>⊘ Do NOT set up chambers in non-ventilated recesses.          ➤ Ensure sufficient ventilation for dispersal of the heat.</p>

- **Permissible ambient temperature range during operation:** +18 °C / 64.4 °F to +32 °C / 89.6 °F. At elevated ambient temperature values, fluctuations in temperature can occur.





The ambient temperature should not be substantially higher than the indicated ambient temperature of +22 °C +/- 3 °C to which the specified technical data relate. For other ambient conditions, deviations from the indicated data are possible.

- **Permissible ambient** humidity: 70 % r.H. max., non-condensing.

When operating the chamber at temperature set-points below ambient temperature, high ambient humidity may lead to condensation on the chamber.

- Installation height: max. 2000 m / 6.6 ft. above sea level.

A water tap (1 bar to 10 bar) is necessary for the installation of the humidification system. If no suitable house water connection is available, you can manually supply water by filling the water can (MKF 56: optional external water can, chap. 4.2.2, 21.9, MKF/MKFT 115, 240, 720: internal water can chap. 4.2.3).



To avoid any possible water damage, provide a floor drain at the location of the device. Select a suitable installation site to avoid any consequential damage by splashing water.

#### Minimum distances:

- Distance between each chamber when placing several chambers of the same size side by side: 250 mm / 9.84 in
- Lateral wall distance: 200 mm / 7.87 in
- Wall distance rear: 300 mm / 11.81 in
- Chambers with optional water cooling (without options compressed air dryer and / or voltage and frequency changer): Wall distance rear 100 mm / 3.94 in.
- Chambers with optional compressed air dryer: Wall distance rear approx. 1 m / 3.28 ft so that it is possible to read the status display of the compressed air dryer on the chamber rear.
- Chambers with voltage and frequency changer: rear wall distance of the alternating climate chamber approx. 1 m / 3.28 ft to set up the voltage and frequency changer
- To completely separate the chamber from the power supply, you must disconnect the power plug. Install the chamber in a way that the power plug is easily accessible and can be easily pulled in case of danger.
- Spacing above the chamber: 100 mm / 3.94 in



### CAUTION

**Danger by stacking.  
Damage to the chambers.**

- ⊘ Do NOT place the chambers on top of each other.

With an increased amount of dust in the ambient air, clean the condenser fan several times a year. We recommend checking the fan grid (behind the left maintenance access flap) every week. In case of visible dirt accumulation, disconnect the chamber and clean the fan grid by suction.

Avoid any conductive dust in the ambience according to the chamber layout complying with pollution degree 2 (IEC 61010-1).

The chamber must not be installed and operated in potentially explosive areas.



### DANGER

**Explosion hazard.  
Danger of death.**

- ⊘ Do NOT operate the chamber in potentially explosive areas.
- ⊘ KEEP explosive dust or air-solvent mixtures AWAY from the vicinity of the chamber.

**MKF 56:** With option "External freshwater and wastewater cans" (chap. 21.9): Install the chamber in a way that the freshwater can is easily accessible for filling.

## 4. Installation and connections

### 4.1 Wastewater connection for humidifying system

Fasten the wastewater hose to the wastewater connection "OUT" (14) on the rear of the chamber (olive  $\varnothing$  14 mm). Observe the following points:

- You can use a part of the supplied tap water hose as a drainage hose. In case another hose is used, it has to be permanently resistant against at least 95 °C / 203 °F.
- Mount the wastewater hose with a maximum positive inclination of 1 m and a maximum total length of 3 m.
- Protect both ends of the drainage hose with two of the four supplied hose clamps.



Wastewater is collected in an internal can with a volume of approx. 0.5 liters. It is pumped off only when required, thus there is no continuous wastewater flow.



Protect the wastewater supply at both sides with the supplied hose clamps.

### 4.2 Freshwater supply for humidifying system



Connect the wastewater pipe **before** connecting the chamber to a freshwater pipe or filling the water can (internal water can: regular with MKF/MKFT 115, 240, 720, external water can: optional for MKF 56).

**MKF 56:** You can supply the chamber with freshwater via a water pipe or by manually filling an external water can (option chap. 21.9).

**MKF/MKFT 115, 240, 720:** You can supply the chamber with freshwater via a water pipe or by manually filling the internal water can. It is not necessary to switch between both possibilities. When connecting to a water pipe, the water can is automatically filled.



Water intake temperature NOT below +5 °C / 41 °F and not exceeding 40 °C / 104 °F.



#### CAUTION

**Calcification of the humidifying system.**

**Damage to the chamber.**

- Operate the chamber with deionized (demineralized) water only.

#### Types of suitable water quality

- Deionized water from a water treatment installation already existing at the customer's site. Conductivity from 1  $\mu$ S/cm up to a maximum of 20  $\mu$ S/cm. (Water, which is in equilibrium with the CO<sub>2</sub> in the air, and has a conductivity below 1  $\mu$ S/cm (ultrapure water), may cause acid corrosion due to its low pH.)
- Tap water treated by the optional water treatment system BINDER Pure Aqua Service (disposable system). A reusable measuring equipment to assess the water quality is included (chap. 21.10).



BINDER GmbH is NOT responsible for the water quality at the user's site.

Any problems and malfunctions that might arise following use of water of deviating quality is excluded from liability by BINDER GmbH.

The warranty becomes void in the event of use of water of deviating quality.

#### 4.2.1 Automatic fresh water supply for humidifying system via water pipe

An enclosure inside the chamber contains the connection kit for water supply and wastewater. Install the water supply connection using either the enclosed water hose or another pressure-resistant one. To accomplish this, remove the cover of the freshwater connection "IN" (15) on the rear of the chamber. Protect both ends of the hose with two of the four supplied hose clamps. Before turning on the chamber, check the connection for leaks. Water supply is automatically effected via the freshwater connection "IN" (15).

	As the chamber only lets in water when required, there is no continuous water flow.
---	---

	<ul style="list-style-type: none"> <li>• Supply pressure 1 to 10 bar when connecting to a water pipe.</li> <li>• Water type: deionized (demineralized) water</li> <li>• Water intake temperature NOT below +5 °C / 41 °F and not exceeding 40 °C / 104 °F.</li> <li>• The water intake shall be provided with a shut-off slide or water-tap.</li> <li>• For the water supply, fix the delivered adapter with hose olive on the thread at the rear of the chamber.</li> <li>• Protect the water supply at one side with the supplied hose clamp.</li> </ul>
---	--

#### 4.2.2 Manual fresh water supply via external freshwater can (option for MKF 56)

If no house water connection with suitable water is available, you can manually supply water by filling a freshwater can (option, volume: 20 liters / 0.71 cu.ft. You can attach the freshwater can on the rear of the chamber or place it next to the chamber (chap. 21.9).

	To guarantee humidification during 24 hours even at high humidity set-points with manual water supply, we recommend filling the freshwater can (option) daily at the end of the day.
---	--

#### 4.2.3 Manual fresh water supply for humidifying system via internal freshwater can (MKF/MKFT 115, 240, 720)

If no house water connection with suitable water is available, you can manually supply water by filling the freshwater can (total volume: 19 liters / 0.67 cu.ft. up to the maximum level mark), which is located behind the right door of the humidity generation module.

The cover of the water inlet valve must be screwed on the freshwater connection "IN" (15). Open the door (F) to access the filler neck of one of the water can. You cannot totally take out the water can because of its fix connections. Fill the water can only up to  $\frac{3}{4}$ , up to the maximum level mark. When filling it too much with the chamber turned on, the alarm message "Freshwater can overflow" is displayed on the controller (chap. 11.1.3). Manually suck off the water, or operate the chamber with high temperature and humidity values until the excess water is consumed. When filling it too much with the chamber turned off, water can escape from the chamber. Thus, ensure not to fill the can by more than the maximum level mark.

	To guarantee humidification during 24 hours even at high humidity set-points with manual water supply, we recommend filling the freshwater can daily at the end of the day.
---	---

#### 4.2.4 Water circle: lever for condensate recycling (option for MKF/MKFT 115, 240, 720)



Figure 11: Lever for condensate recycling (open position) next to the freshwater can behind the maintenance access door

The lever (25) for condensate recycling is located behind the maintenance access door next to the freshwater can.

- Open lever (vertical position): the condensate from the interior is conducted to the freshwater can. Use only with clean interior!
- Closed lever (horizontal position): the condensate is conducted to the wastewater connection. Use this position in case of soiling / contamination of the interior.

	<b>CAUTION</b>
	<p><b>Soiling of the vapor humidification system.</b>  <b>Damage to the chamber.</b></p> <p>➤ Conduct the condensate to the wastewater connection in case of soiling / contamination of the interior (horizontal lever position).</p>

#### 4.3 Connection of cooling water outlet for water cooling (option)

An enclosure inside the chamber contains the connection kit for the cooling water inlet and outlet.

- Fasten the cooling hose to the connection “OUT” (16) on the rear of the chamber (screw thread  $\frac{3}{4}$ ”).
- You can use a part of the supplied tap water hose as a drainage hose. In case another hose is used, it has to be permanently resistant against max. 50 °C / 122 °F.
- Protect both ends of the drainage hose with two of the four supplied hose clamps. Before turning on the chamber, check the connection for leaks.

#### 4.4 Connection of cooling water inlet for water cooling (option)



Connect the cooling water outlet **before** connecting the cooling water inlet.

##### Type of suitable water quality:

- Water intake temperature: max. 10 °C / 50 °F.
- pH value 4-7
- connection pressure: 4 to 10 bar



BINDER GmbH is NOT responsible for the water quality at the user's site.  
Any problems and malfunctions that might arise following use of water of deviating quality is excluded from liability by BINDER GmbH.  
The warranty becomes void in the event of use of water of deviating quality.

##### Connection:

An enclosure inside the chamber contains the connection kit for the cooling water inlet and outlet.

- Fasten the cooling water hose to the connection "IN" (17) on the rear of the chamber (screw thread  $\frac{3}{4}$ ").
- Install the water supply connection using either the enclosed water hose or another pressure-resistant one. To accomplish this, remove the cover of the freshwater connection "IN" (17) on the rear of the chamber.
- The nominal diameter of the supplied water hose is  $\frac{1}{2}$  ", the length is 3m. The hose can be halved for the inlet and the outlet.
- The maximum hose length with nominal width  $\frac{1}{2}$  " is 5m. If a longer hose is necessary, a larger diameter hose must be used
- Protect both ends of the hose with two of the four supplied hose clamps. Before turning on the chamber, check the connection for leaks.

##### Water consumption:

The average water demand is not helpful for the design of the water supply line, since the supply line must provide sufficient dimensions for peak loads.

Peak values occur briefly (<5 min) when temperature rapidly decreases from + 180 ° C to a much lower value. Also the activation of the condensation protection leads to high water consumption.

Max. water flow rate (peak value):

- MKF / MKFT 720: approx. 2 m<sup>3</sup>/h
- MKF / MKFT 240: approx. 1 m<sup>3</sup>/h
- MKF / MKFT 115: approx. 0,8 m<sup>3</sup>/h
- MKF / MKFT 56: approx. 0,6 m<sup>3</sup>/h

#### 4.5 Connection kit for connecting the chamber's freshwater connection to a water pipe

A safety kit against flooding caused by burst water hoses is enclosed with the chamber. It consists of the following:

- Hose burst protection device
- Hose nozzle with screwing
- 4 hose clamps
- 6m water hose, divisible for the feed hose and drain

### Protection principle of hose burst protection:

Whenever a strong water flow of approx. 18 l / min. occurs, e.g. caused by a burst water hose, a valve automatically cuts off the water supply, which can be heard as a clicking noise. The water supply now remains shut until it is manually released.

### Assembly:

Screw the hose burst protection device onto a water tap with a G $\frac{3}{4}$  inch right turning thread connection. The connection is self-sealing. Establish the connection between the safety kit and the chamber with a part of the supplied hose. Protect both ends of the hose by the supplied hose clamps.

We recommend connecting the hose as the last step in order to avoid twisting the hose while screwing on the safety kit.

Open the water tap slowly in order to avoid actuating the hose burst protection device.

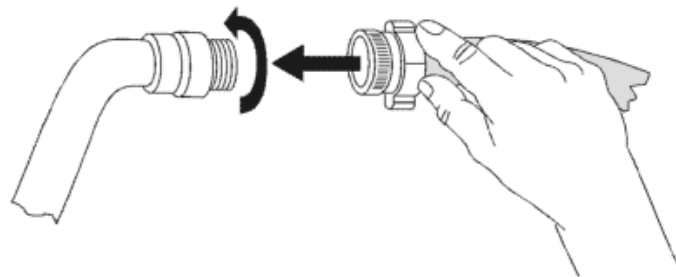



Figure 12: Assembly of the connection kit

### Release of the reflux protection device:

In case the burst protection device has interrupted the water supply, first find the reason and remove it as necessary. Close the water tap. Release the valve by a half left-turn of the upper knurled part. You can hear the release of the valve as a clicking noise. Tighten the burst protection device against the water tap by a right turn. Open the water tap slowly afterwards.

### Maintenance of the assembly of the hose burst protection device:

Calcification can impair valve function. We recommend an annual inspection by a skilled plumber. The plumber should remove the safety kit to check the valve by hand for proper function and calcification or blockage.

	<b>CAUTION</b>
	<p><b>Danger of calcification.</b> <b>Impairment of valve function.</b></p> <ul style="list-style-type: none"> <li>➤ Have a plumber inspect the valve annually.</li> <li>➤ Remove calcifications by citric acid or acetic acid solutions.</li> <li>➤ Continue by testing the function and tightness of the mounted unit.</li> </ul>

Check: Quickly open the water tap while there is no chamber connected – the valve should cut off the water flux without any delay.

## 4.6 Safety kit: Hose burst protection device with reflux protection device for the chamber's freshwater connection (available via BINDER INDIVIDUAL customized solutions)

A safety kit with a reflux protection device is available for protection of the drinking water system and against flooding caused by burst water hoses.

### Protection principles:

Whenever a strong water flow of approx. 18 l / min. occurs, e.g. caused by a burst water hose, a valve automatically cuts off the water supply, which can be heard as a clicking noise. The water supply now remains shut until it is manually released.

A possible endangering of the drinking water system depends on the risk potential of the charging material. Under unfavorable conditions (e.g. decreasing pressure inside the tap water system), drained off charging material could be sucked out of the chamber via the steam generator into the tap water system and therefore contaminate the drinking water. The safety kit with a reflux protection device provides security in case of short-term utilization of substances with low risk potential. When using substances bearing a higher risk potential, install a pipe disconnecter to assure absolute protection. It is the user's responsibility to prevent (according to national standards) any reflux of contaminated water from getting into the drinking water system.

### Assembly:

The standard supplied parts – hose burst protection device, hose nozzle with screwing – are not needed.

Screw the pre-mounted assembly of the hose burst protection and reflux protection devices onto a water tap with a G $\frac{3}{4}$  inch right turning thread connection. The connection is self-sealing. Establish the connection between the safety kit and the chamber with a part of the supplied hose. Protect both ends of the hose with the supplied hose clamps.

We recommend connecting the hose as the last step in order to avoid twisting it while screwing on the safety kit.

Open the water tap slowly in order to avoid actuating the hose burst protection device.

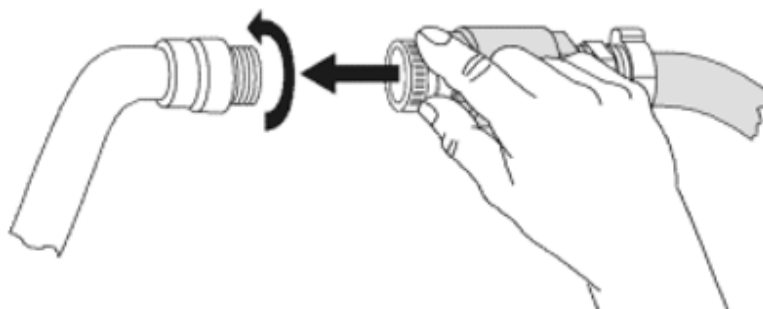



Figure 13: Assembly of the safety kit: hose burst protection and reflux protection devices (option)

### Release of the reflux protection device:

In case the hose burst protection device interrupts the water supply, first find the reason and remove it as necessary. Close the water tap. Release the valve by a half left-turn of the upper knurled part. You can hear the release of the valve as a clicking noise. Tighten the burst protection device against the water tap by a right turn. Open the water tap slowly afterwards.

### Maintenance of the assembly of hose burst protection and reflux protection devices:

Calcification can impair the function of both valves. We recommend an annual inspection by a skilled plumber. The plumber should remove the safety kit with the reflux protection device to check the two valves by hand for proper function and calcification or blockage.





	<b>CAUTION</b>
	<p><b>Danger of calcification.</b>  <b>Impairment of valve function.</b></p> <ul style="list-style-type: none"> <li>➤ Have a plumber inspect the two valves annually.</li> <li>➤ Remove calcifications by citric acid or acetic acid solutions.</li> <li>➤ Continue by testing the function and tightness of the mounted unit.</li> </ul>

Check: Quickly open the water tap while there is no chamber connected – the valve should cut off the water flux without any delay.



## 4.7 Installation of the voltage and frequency changer (chambers with voltage and frequency changer)

The voltage and frequency changer is supplied packed separately together with the chamber.

  	 <b>CAUTION</b>
	<p><b>Sliding or tilting of the voltage and frequency changer.</b>  <b>Damage to the voltage and frequency changer.</b>  <b>Risk of injury by lifting heavy loads.</b></p> <p>⊘ Do NOT lift the voltage and frequency changer by hand.</p> <p>➤ Lift the voltage and frequency changer from the pallet using technical devices (fork lifter). Set the fork lifter only from the rear in the middle of the chamber.</p> <p>➤ Alternatively, the voltage and frequency changer can also be lifted at the eyelets on the top by means of a lifting crane or fork lifter</p>



- (a) Eyelets for lifting with a lifting crane or fork lifter  
 (b) Positions for a fork lifter

Figure 14: Positioning of aids for lifting the voltage and frequency changer

For the installation of the voltage and frequency changer behind the chamber, provide a rear wall distance of the chamber of approx. 1 m / 3.3 ft.

If possible, fix the voltage and frequency changer at the chamber. For this purpose, an Allen key size 4 is required. Connect the slots at the end of the chassis with two M6 screws to the threads provided below on the rear panel of the chamber (see Figure 15).

	<b>CAUTION</b>
	<p><b>Danger of overheating.</b>  <b>Damage to the voltage and frequency changer.</b></p> <ul style="list-style-type: none"> <li>⊘ Do NOT install the voltage and frequency changer in unventilated recesses.</li> <li>➤ Ensure sufficient ventilation for dispersal of the heat.</li> </ul>

The voltage and frequency changer is equipped with four castors. The rear castors can be easily locked via the attached brakes

## 4.8 Electrical connection

### 4.8.1 Information on connecting the alternating climate chamber

The chambers are supplied ready for connection.

**MKF 56:** The chambers come with an IEC connector plug. They are equipped with an internal overload release against excess-current.

**MKF/MKFT 115,240,720:** The chambers come with a fixed power connection cable of at least 1800 mm / 70.87 in in length. They are equipped with three internal overload releases against excess-current.

Model	Power plug	Nominal voltage +/- 10% at the indicated power frequency	Current type	Chamber fuse
MKF 56 (230V)	IEC connector plug (grounded plug)	230 V at 50 Hz	1 N~	16 Amp internal
MKF 56 (240V)	IEC connector plug (grounded plug)	240 V at 50 Hz	2~	16 Amp internal
MKF 115 MKFT 115 MKF 240	CEE plug 5-poles 16 Amp	400 V at 50 Hz	3 N~	16 Amp 3 x internal
MKFT 240	CEE plug 5-poles 16 Amp	400 V at 50 Hz	3 N~	16 Amp 3 x internal
MKF 720 MKFT 720	CEE plug 5-poles 32 Amp	400 V at 50 Hz	3 N~	25 Amp 3 x internal

- The socket must also provide a protective conductor.
- Prior to connection and start-up, check the power supply voltage. Compare the values to the specified data located on the chamber's type plate (left chamber side, bottom right-hand, chap. 1.4)
- When connecting, please observe the regulations specified by the local electricity supply company and as well as the VDE directives (for Germany). We recommend the use of a residual current circuit breaker.
- MKF 56: Only use original connection cables from BINDER
- Pollution degree (acc. to IEC 61010-1): 2
- Over-voltage category (acc. to IEC 61010-1): II

	<b>CAUTION</b>
	<p><b>Danger of incorrect power supply voltage.</b>  <b>Damage to the equipment.</b></p> <ul style="list-style-type: none"> <li>➤ Check the power supply voltage before connection and start-up.</li> <li>➤ Compare the power supply voltage with the data indicated on the type plate.</li> </ul>

See also electrical data (chap. 25.4 and 25.5).



To completely separate the chamber from the power supply, you must disconnect the power plug. Install the chamber in a way that the power plug is easily accessible and can be easily pulled in case of danger.

#### **4.8.2 Connecting the voltage and frequency changer (for chambers equipped with a voltage and frequency changer)**

The voltage and frequency changer is supplied with a fixed power connection cable without a plug. It is protected against excess-current with 3 internal overload releases. The connection is made by the customer.

The socket must provide a protective conductor.

Electrical connection data:

- Input side: 480 V, 60 Hz, 4-wire
- Output side (to the chamber): 400 V, 50 Hz, 5-wire

To establish the electrical connection of the alternating climate chamber with the voltage and frequency changer, proceed in the following order:

1. Connect the chamber to the connection socket (G) of the voltage and frequency changer
2. Establish the power connection of the voltage and frequency changer using the power cable (I)
3. Turn on the voltage and frequency changer at the power switch (H) (position "ON")
4. Turn on the chamber with the main power switch (3) in the lateral control panel

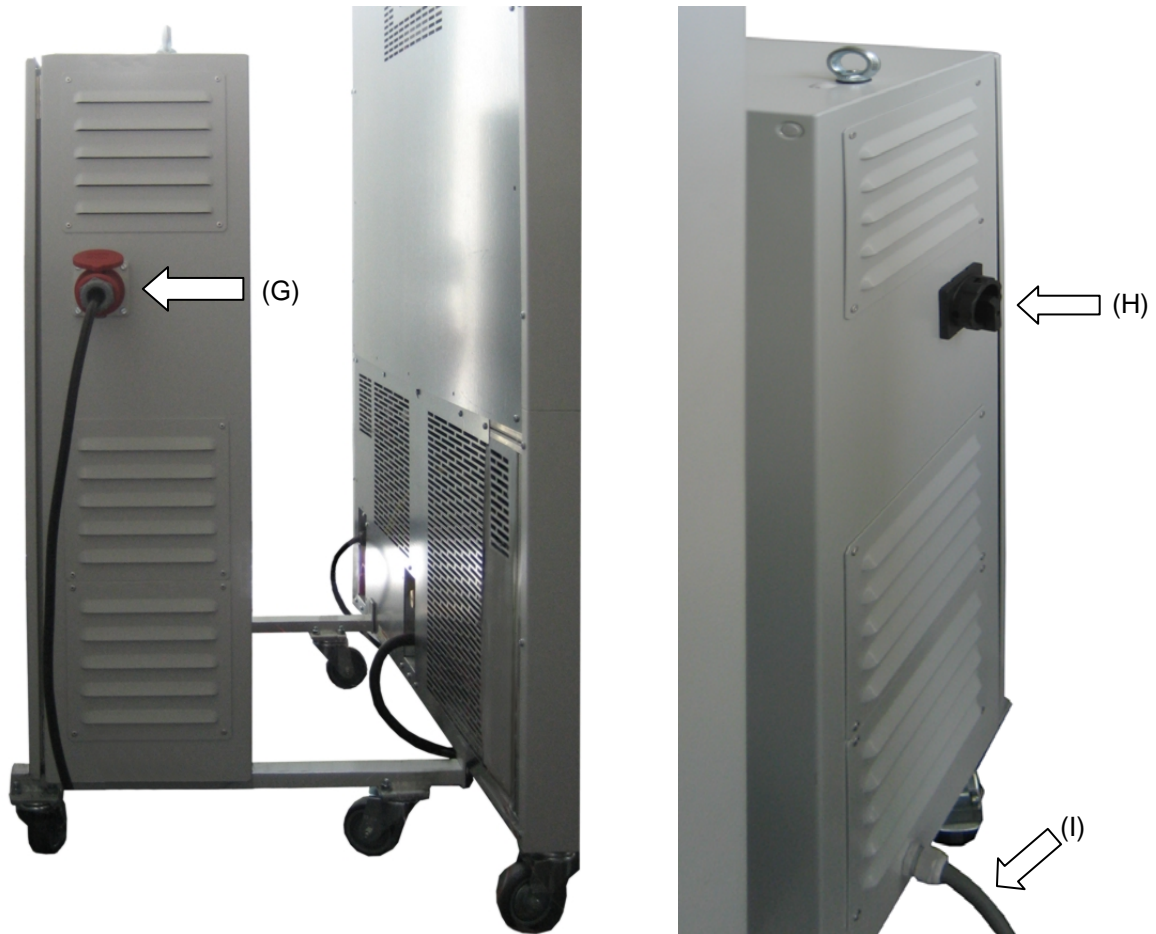

Left side of the voltage and frequency changer with connection socket (G) for the alternating climate chamber

Right side of the voltage and frequency changer with power switch (H) and power cable (I)

Figure 15: Voltage and frequency changer, mounted



Figure 16: Power switch (H) of the voltage and frequency changer in position "ON"

In position "OFF" the switch can be locked, e.g. with a padlock.

## 5. Functional overview of the MB2 chamber controller

The MB2 chamber controller controls following parameters inside the chamber:

- Temperature in °C
- Relative humidity in % r.H.
- Fan speed in %

For the control ranges of temperature and humidity, see climatic diagrams (chap. 17).

You can enter the desired set point values in fixed value operation mode directly on the display surface or via the setpoint menu. For program operation the controller offers programming week and time programs. In addition there is a timer program available (stopwatch function).

The controller offers various notifications and alarm messages with visual and audible indication and remote alarms via e-mail, an event list (trace file) and the graphical display of the measuring values in the in der chart recorder view. The MB2 program controller permits programming temperature and humidity cycles, and specifying the fan speed and special controller functions for each program section. You can enter values or programs directly at the controller or use the APT-COM™ 3 DataControlSystem software (option) specially developed by BINDER.

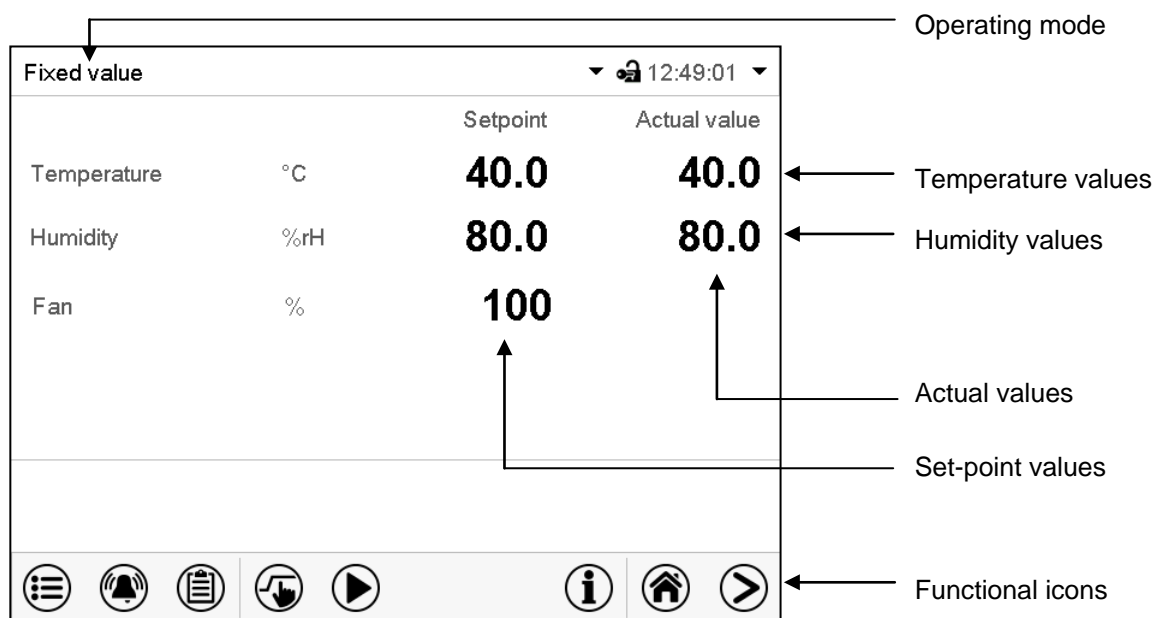

Figure 17: Normal display of the MB2 program controller (sample values)

## 5.1 Operating functions in normal display

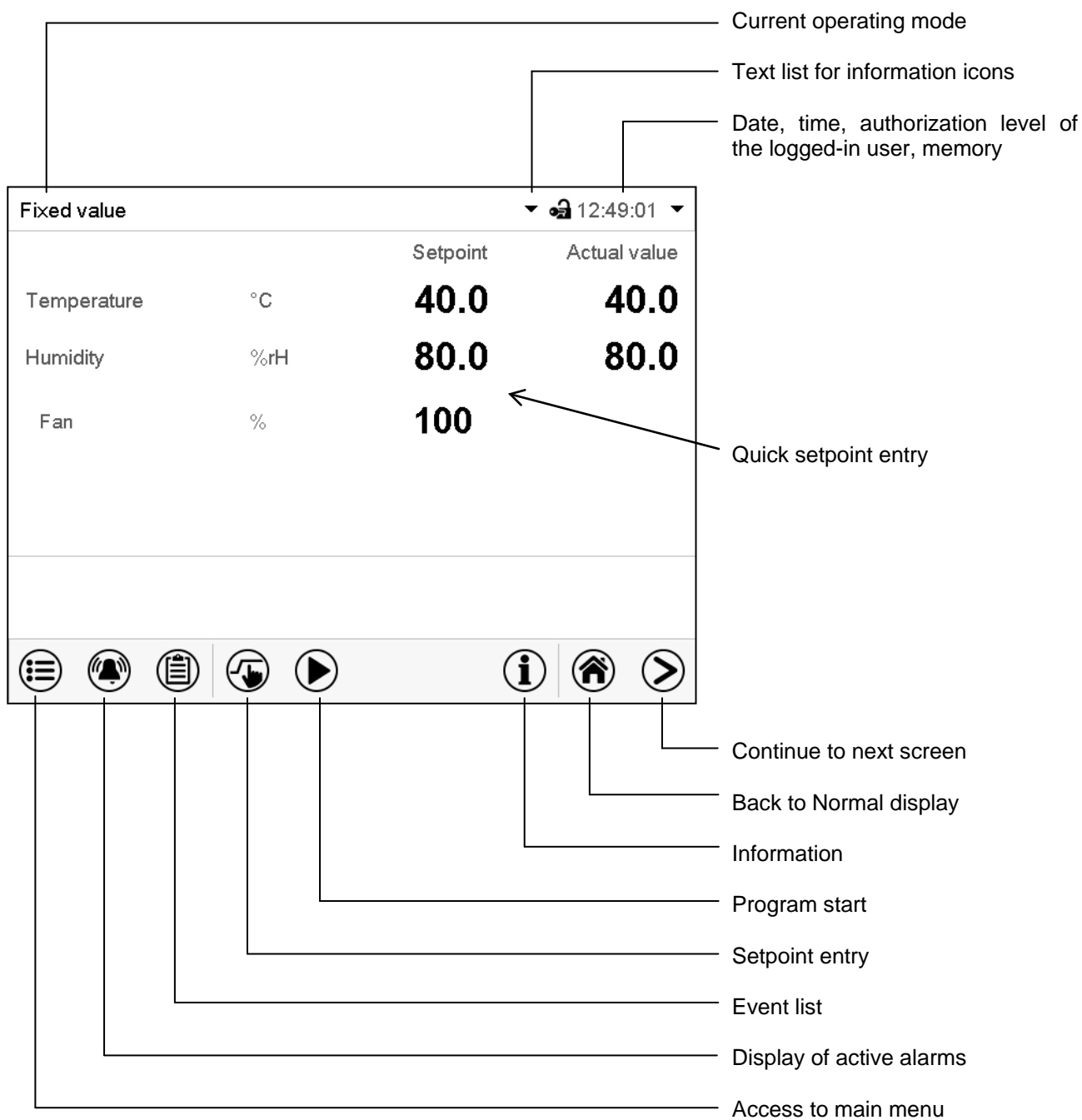

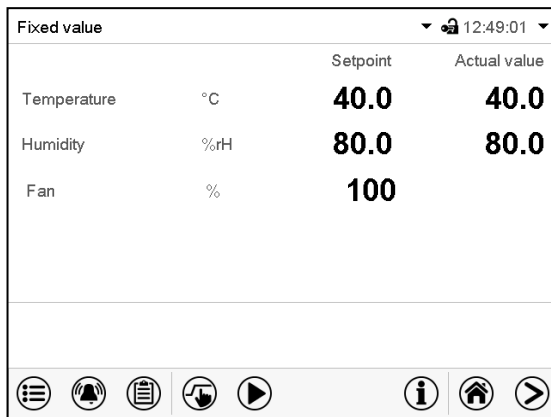

Figure 18: Operating functions of the MB2 controller in normal display (example values)

## 5.2 Display views: Normal display, program display, chart-recorder display

	Press the <b>Change view</b> icon to toggle between normal display, program display and chart-recorder display.
	Press the <b>Normal display</b> icon to return from program display and chart recorder display back to Normal display.



Normal display (actual values / setpoint values)

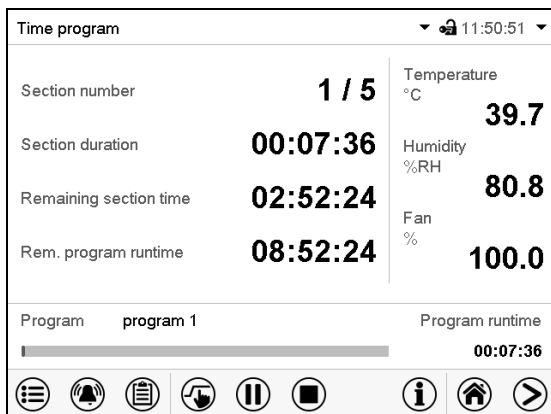

Program display (example: time program)

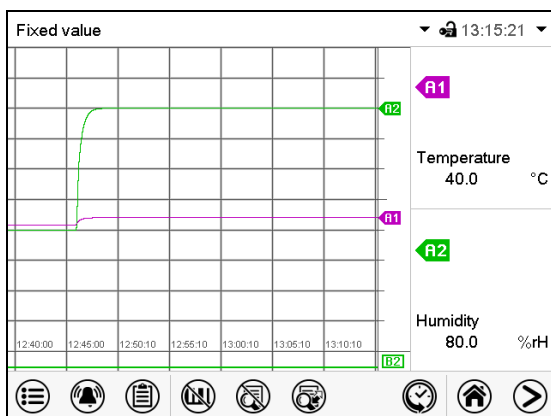



















Chart recorder display

### 5.3 Controller icons overview

#### Navigation icons in Normal display











Icon	Signification	Function
	<b>Main menu</b>	Access from Normal display to the main menu
	<b>Alarm</b>	Access from Normal display to the list of active alarms
	<b>Event list</b>	Access from Normal display to the event list
	<b>Setpoint setting</b>	Access from Normal display to the setpoint entry menu: setpoint entry for Fixed value operation, turning on/off humidity control, safety controller settings
	<b>Program start</b>	Start a previously entered time or week program, continue a paused time program
	<b>Program pause</b>	Pause a running time program
	<b>Program cancelling</b>	Cancel a running time or week program
	<b>Information</b>	Information on program operation, setpoints, actual values, and the safety controller
	<b>Normal display</b>	Return from program display or chart recorder display to Normal display
	<b>Change view</b>	Toggle between Normal display, program display, and chart recorder display
	<b>Interior lighting</b>	Turn on and off the interior lighting

#### Functional icons in individual menus







Icon	Signification	Function
	<b>Back</b>	Return from each menu to Normal display
	<b>Update</b>	Update the event list and alarm messages
	<b>Confirm</b>	Take over the entries and exit the menu / continue menu sequence.
	<b>Close</b>	Exit the menu / cancel menu sequence. Entries are not taken over. When terminating a menu sequence, an information window appears, which must be confirmed.
	<b>Reset alarm</b>	Acknowledge the alarm and mute the buzzer.
	<b>Change keyboard</b>	Change between uppercase and lower case characters, digits and special characters
	<b>Edit</b>	Edit settings of time and week programs



### Functional icons in the chart recorder display

Icon	Signification	Function
	<b>Show legend</b>	Show legend
	<b>Hide legend</b>	Hide legend
	<b>Switch legend</b>	Switch between legend pages
	<b>Show indications</b>	Show indication "Door open" (B1), "Anti-condensat." (B2) and "Compressed air" (B3)
	<b>Hide indications</b>	Hide indication "Door open" (B1), "Anti-condensat." (B2) and "Compressed air" (B3)
	<b>History display</b>	Pause chart recorder and change to history display. Data recording continues.
	<b>Curve selection</b>	Go to "Curve selection" submenu in the history display
	<b>Search</b>	Go to "Search" submenu in the history display to select the required instant
	<b>Zoom</b>	Go to "Zoom" submenu in the history display to select the zoom factor
	<b>Show scroll buttons</b>	Show scroll buttons in the history display to scroll to an instant
	<b>Hide scroll buttons</b>	Hide scroll buttons in the history display to scroll to an instant

### Information icons referring to chamber conditions

Icon	Text information	Condition
	"Idle mode"	Controller is in Idle mode
	"Door open"	Chamber door is open
	"Humidity off"	The humidification / dehumidification system is turned off
	"Preheating phase"	1-hour preheating phase, no cooling or dehumidification function
	"Anti-condensation"	Operation line "Anti-condensation" on: anti-condensation protection activated
	Compressed Air Dryer	Compressed air dryer (option) activated with operation line "Compr. air dryer" (MKF/MKFT 115, 240, 720)

### Information icon for data processing

Symbol	Information
	Waiting symbol: Data processing is running. Remaining time to touch the display when calibrating the touchscreen.

---

## 5.4 Operating modes

The MB2 program controller operates in the following operating modes:

- **Idle mode**

The controller is not functional, i.e., there is no heating or refrigeration and no humidification or dehumidification. The fan is off. The chamber approximates ambient values.

You can activate and deactivate this operating mode with the “Idle mode” control contact in Fixed value operating mode (chap. 7.3), time program operation (chap. 9.7.3) and week program operation (chap. 10.6.5).

- **Fixed value operating mode**

The controller operates as a fixed-point controller, i.e., set-points can be defined, which are then maintained until the next manual change (chap. 7.1).

- **Timer program operation**

Stopwatch function: during an entered duration the controller constantly equilibrates to the setpoints entered in Fixed value operation mode.

- **Time program operation**

An entered time program for temperature and humidity is running. The controller offers 25 program memory places with 100 program sections each. The total number of program sections of all programs is unlimited

- **Week program operation**

An entered week program for temperature and humidity is running. The controller offers 5 program memory places with 100 switching points each. The switching points can be distributed over all days of the week.





## 5.5 Controller menu structure

Use the **navigation icons** in the screen footer in Normal display to access the desired controller functions.

Fixed value		12:49:01	
		Setpoint	Actual value
Temperature	°C	<b>40.0</b>	<b>40.0</b>
Humidity	%rH	<b>80.0</b>	<b>80.0</b>
Fan	%	<b>100</b>	



The available functions depend on the current **authorization level** "Service", "Admin" or "User" (chap. 13.1). This is selected either during login or can be available without password protection.

	<b>Main menu:</b> program settings, further information, "Service" submenu. The "Settings" submenu allows general configuration of the controller.	chap. 5.5.1
	List of <b>active alarms</b>	chap. 11
	Access to the <b>event list</b>	chap. 15.2
	<b>Setpoint entry</b> for Fixed value operation, turning on/off <b>humidity control</b> , <b>safety controller</b> settings	chap. 7, 6.3, 12.2
	Start/ pause/ cancel an already entered, respectively a running <b>time program</b> or start / cancel an already entered, respectively a running <b>week program</b>	chap. 9.1, 9.2, 10.1

Unless noted otherwise, the figures show the functional range, which is available for the user with "Admin" authorization level.

### 5.5.1 Main menu

The main menu provides access to the general configuration of the controller as well as to program entry and the user administration. Additionally there are support functions like a contact page or the display calibration depending on the available angle.

	Press the <b>Main menu</b> icon to access the main menu from Normal Display.
	Press the <b>Back</b> icon to return from each setting menu to Normal Display.

The main menu provides the following functions and submenus.

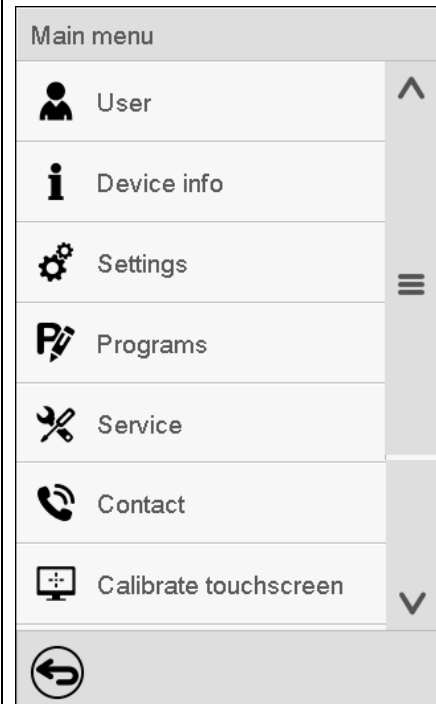
	User management: login and logout, password management	chap. 13
	Chamber information	chap. 15.2
	"Settings" submenu (not visible for user with "User" authorization level)	chap. 14
	Program entry submenu for time and week programs	chap. 9 and 10
	"Service" submenu	chap. 5.5.3
	BINDER Service contact page	chap. 15.1
	Calibrating the touch screen	chap. 14.4.2
	Back to Normal Display	

#### "Settings" submenu

- Settings of many general controller functions and network settings (chap. 14).
- Available only for users with "Service" and "Admin" authorization level

#### "Service" submenu

- Access to service data, controller reset to factory settings (chap. 5.5.3)
- Available only for users with "Service" and "Admin" authorization level. Full functional range only for BINDER Service (users with "Service" authorization level).

#### "Programs" submenu

- Access to the controller's program functions (chap. 8, 9, 10)

### 5.5.2 “Settings” submenu

The “Settings” submenu is available for users with “Service” or “Admin” authorization level. It serves to enter date and time, select the language for the controller menus and the desired temperature unit and to configure the controller’s communication functions.

Path: [Main menu > Settings](#)

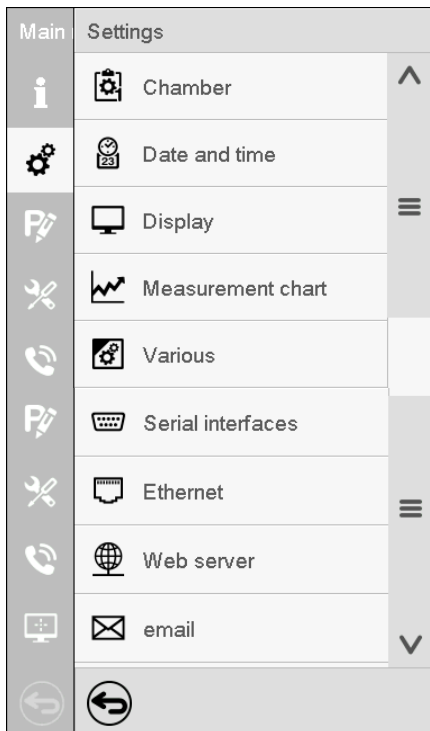
	Settings		
	Chamber	Setting the temperature unit, menu language...	chap. 14.1, 14.2
	Date and time	Setting date and time	chap. 14.2
	Display	Setting the display brightness, continuous operation and screen saver	chap. 14.4
	Measurement chart	Settings for the measurement chart: storage interval, storage values, minimum and maximum values	chap. 16.2
	Various	Turning off the interior lighting automatically	chap. 14.7
	Serial interfaces	Configuration of the optional RS485 interface, setting of the device address	chap. 14.5.1
	Ethernet	Entry of the MAC address and IP address	chap. 14.5.2
	Web server	Password protection for web server access	chap. 14.5.3
	email	Configuration of the e-mail server, assignment of e-mail addresses	chap. 14.5.4
		Back to main menu	

### 5.5.3 “Service” submenu

The “Service” submenu is available for users with “Service” or “Admin” authorization level. When logged-in with “Admin” authorization level the user will find information to tell the BINDER Service in service case.

Path: [Main menu > Service](#)

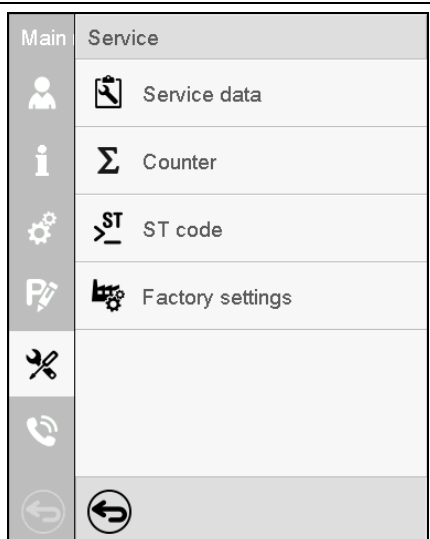
	Service		
	Service data	Serial number of the chamber, setup version of the controller software	chap. 14.2
	Counter	No function	
	ST code	Information for BINDER Service	
	Factory settings	Reset to factory settings	
		Back to main menu	

(view with “Admin” authorization level)

## 5.6 Principle of controller entries

In the selection and entry menus there are icons displayed in the footers which you can use to take over the entry or cancel it.

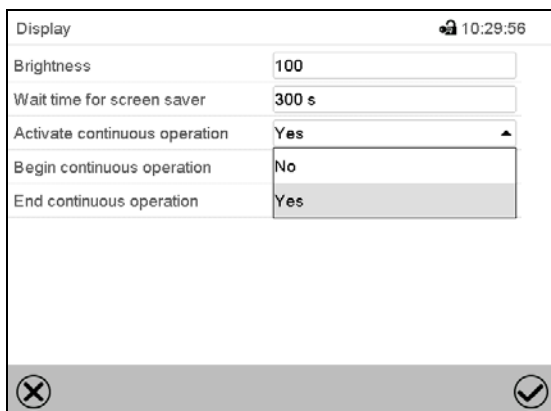

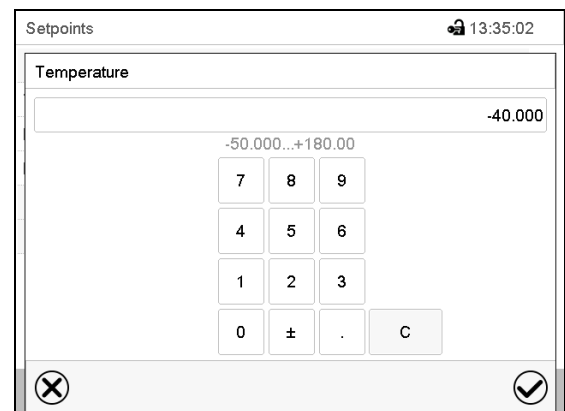

Selection menu (example)



Entry menu (example)

After completing the settings there are the following possibilities:

	Press the <b>Confirm</b> icon to take over the entries and exit the menu or continue the menu sequence.
	Press the <b>Close</b> icon to exit the menu or cancel the menu sequence without taking over the entries. When terminating a menu sequence, an information window appears, which must be confirmed.

## 5.7 Performance during and after power failures

During a power failure, all controller functions are shut down.

After the power returns, all functions return to the same status the chamber had before power failure. The controller continues to function in the original operating mode it was in previously before the power failure occurred.

- Performance after power failure in Idle mode  
Control is deactivated
- Performance after power failure in Fixed value operation mode  
All functions return to the same status the chamber had before power failure. The set-points are immediately resumed.
- Performance after power failure during time program operation  
The program is resumed at the point where the interruption occurred with the latest set-points reached during the program run.
- Performance after power failure during week program operation  
The week program continues with the values corresponding to the current time.

Power failure and power return are noted in the event list (chap. 15.3).

If during power failure an alarm has occurred (tolerance range, safety controller, optional over/under temperature safety device class 2), confirm the alarm. See chap. 11.3.

## 5.8 Performance when opening the door

When you open the door the fan starts running with minimum speed.

After 60 seconds from opening the door, heating, refrigeration, humidification, dehumidification and fan turn off. The compressor continues operating during 5 minutes without cooling function.

After closing the door, heating, refrigeration, humidification, dehumidification and fan turn on again.

## 6. Start up

### 6.1 Turning on the chamber

After connecting the supply lines (chap. 4), you can start up the chamber.

- **MKF 56:** Turn on the main power switch (1) in the lateral control panel at least one hour before operating the chamber.
- **MKF/MKFT 115, 240, 720:** Turn on the main power switch (1) in the lateral control panel and the rear power switch (12) at least one hour before operating the chamber
- The lit pilot lamp shows the chamber is ready for operation. When the chamber has been turned on and yet the controller display is dark, the display is in stand-by mode. Press on the touchscreen to activate it.
- Open the water-tap for supply. Alternatively, fill the freshwater can (internal water can: regular with MKF/MKFT 115, 240, 720, external water can: optional for MKF 56).
- The humidifying and dehumidifying system must be activated (deactivated operation line "Humidity off", chap. 7.3 and setting "Control on", chap. 6.3).

After the first turning on of the humidity or after an interruption of the power supply the relative humidity will increase after a delay of approx. 20 minutes. During this period, the relative humidity can drop considerably.

**MKF 56:** The refrigerating and dehumidification functions are available only one hour after turning on the main power switch (1). This is indicated by the information message "Preheating phase" in the controller display.

**MKF/MKFT 115, 240, 720:** The refrigerating and dehumidification functions are available only one hour after turning on the main power switch (1) and the rear power switch (12). This is indicated by the information message "Preheating phase" in the controller display. After 1 minute the information message "Water can empty" appears on the controller display. You can reset this message only after the 1-hour preheating phase.

Warming chambers may release odors in the first few days after commissioning. This is not a quality defect. To reduce odors quickly we recommend heating up the chamber to its nominal temperature for one day and in a well-ventilated location.



For control reasons the refrigeration machine starts with a delay time. The refrigeration machine also turns off with a 5 minutes delay. This explains why the compressor may remain operating also during positive temperature jumps.

## 6.2 Controller settings upon start up

The window “Language selection” enables the **language selection**, in case that it’s activated in the “Start-up” menu. Afterwards occurs a request of the **time zone** and the **temperature unit**.

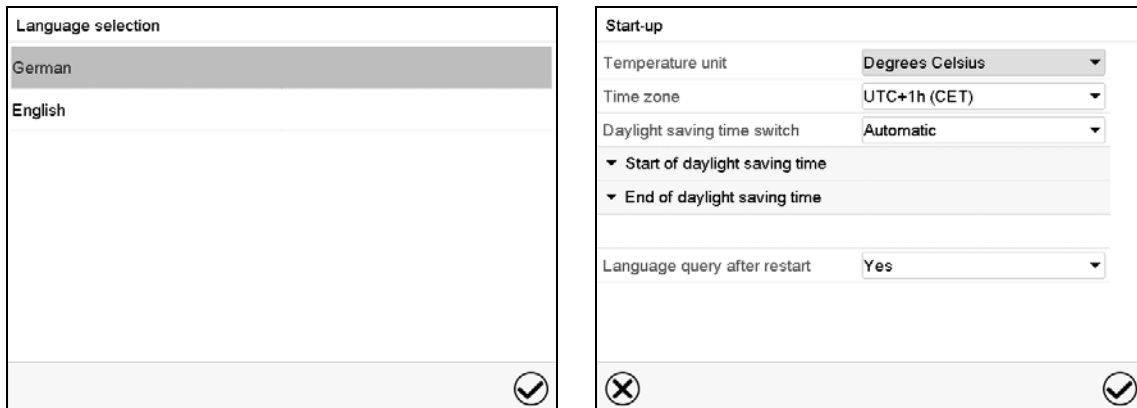

The controller will function in the **operating mode**, which was active before the last shut-down. It controls temperature in fixed value operating mode to the last entered values and in the program mode to the set points achieved beforehand.

### Locked operation

Provided that the user administration has been activated by the assignment of passwords for the different authorization types, the **controller operation** is first locked after turning on the unit, recognizable by the closed lock icon in the header.

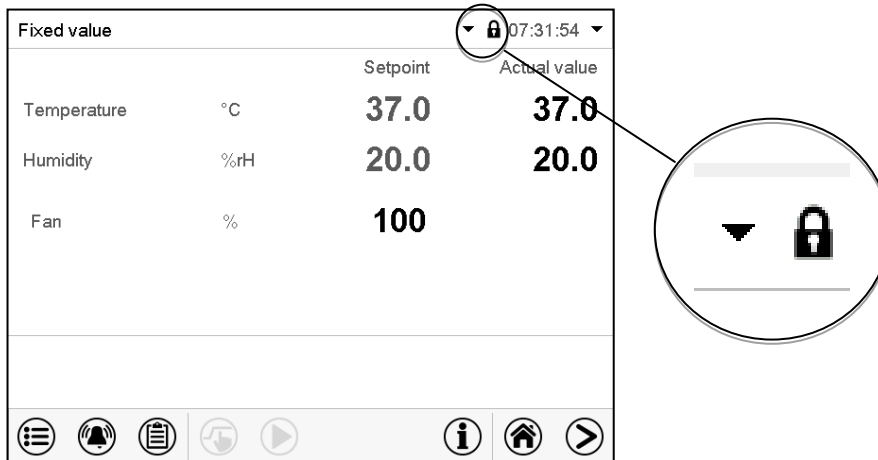

In the locked view the controller provides all display functions. No setting functions are available.

The setpoints are shaded (light grey) in normal display. Changing them by direct entry in the fixed value operating mode is not possible. The functional icons for setpoint entry and program start in the footer are without function.

After turning on the unit, user log-in is required to operate the controller (chap. 13.2).

### Operation without user log-in / without password-protection

If the password function has been deactivated, after turning on the unit without user log-in there are those controller functions available, which correspond to the highest authorization level without a password protection. There is no lock icon in the header.



### 6.3 Turning on/off humidity control

Turning off humidity control is required when operating the chamber without water connection in order to avoid humidity alarms. For further information see chap. 17.

 Press the **Setpoint setting** icon to access the “Setpoint” setting menu from Normal display.

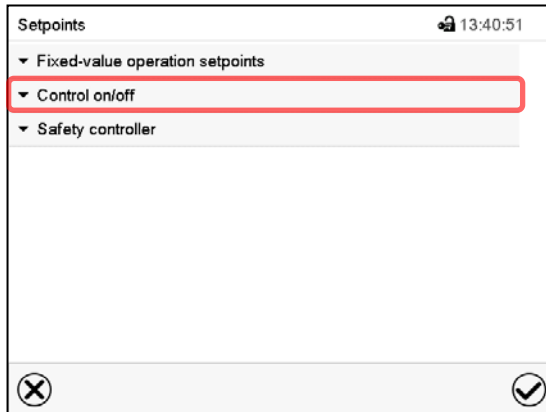

“Setpoints” menu.  
Select “Control on/off”.

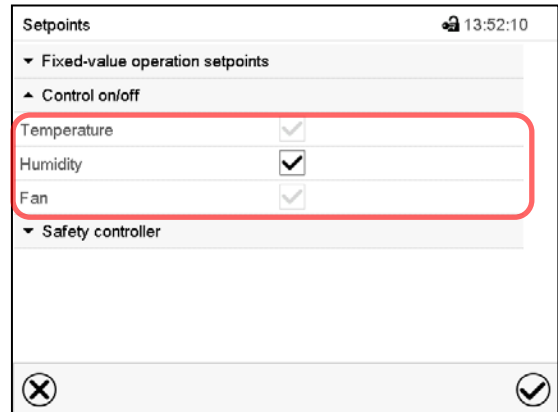

You can turn humidity control (humidification and dehumidification) on or off.  
If the “Humidity” checkbox is marked, humidity control is active. Mark / unmark the checkbox to change the setting.

## 7. Set-point entry in “Fixed value” operating mode

In Fixed value operating mode you can enter a temperature set-point, the fan speed, and the switching-state of up to 16 operation lines.

All settings made in Fixed value operating mode remain valid until the next manual change. They are saved also when turning off the chamber or in case of toggling to Idle Mode or Program Mode.

- **Temperature MKF**

<b>Setting range</b>	-50 °C / -58 °F up to 180 °C / 356 °F	(range -50 °C / -58 °F up to -40 °C / -40 °F not provided for operation)
<b>Control ranges</b>	-40 °C / -40 °F up to 180 °C / 356 °F	without humidity
	+ 10 °C / 50 °F up to +95 °C / 203 °F	in climatic operation
	0 °C / 32 °F up to +95 °C / 203 °F	in climatic operation with optional compressed air dryer

- **Temperature MKFT**

<b>Setting range</b>	-80 °C / -112 °F up to 180 °C / 356 °F	(range -80 °C / -112 °F up to -70 °C / -94 °F not provided for operation)
<b>Control ranges</b>	-70 °C / -94 °F up to 180 °C / 356 °F	without humidity
	+ 10 °C / 50 °F up to +95 °C / 203 °F	in climatic operation
	0 °C / 32 °F up to +95 °C / 203 °F	in climatic operation with optional compressed air dryer

- **Humidity**

<b>Setting range</b>	0% r.H. up to 100 % r.H.	
<b>Control ranges</b>	10 % r.H. up to 98 % r.H.	
	5 % r.H. up to 98% r.H.	with optional compressed air dryer

- **Fan speed**

<b>Setting range</b>	30 % up to 100 %	
----------------------	------------------	--

See temperature / humidity diagrams in chap. 17

	<p>Reduce the fan speed only if required, because the spatial temperature distribution of will also be reduced.</p> <p><b>Technical data refers to 100% fan speed.</b></p>
---	--

For the control range of temperature and relative humidity, see the temperature / humidity diagram (chap. 17).

	<p>With set-point type “<b>Limit</b>”, adapt the safety controller (chap. 12.2) or the over/under temperature safety device class 2 (option, chap. 12.3) always when you changed the temperature set-point. Set the safety controller set-point or the set-point of the over/under temperature safety device class 2 (option) by approx. 2 °C to 5 °C above the controller temperature set-point.</p> <p>Recommended setting: Set-point type “<b>Offset</b>” with safety controller set-point 2 °C.</p>
---	---

## 7.1 Set-point entry through the “Setpoints” menu

	Press the <b>Setpoint setting</b> icon to access the “Setpoint” setting menu from Normal display.
---	---

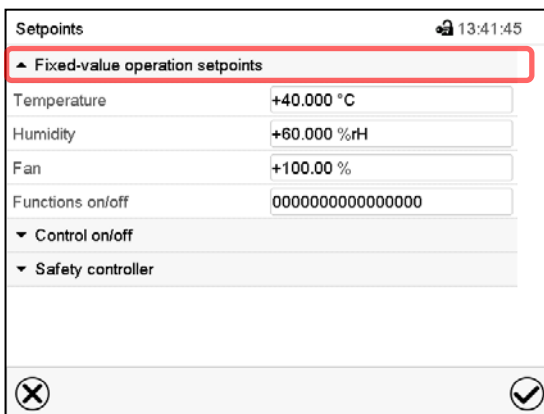

“Setpoints” menu.

Select “Fixed value operation setpoints” to access the individual parameters.

- Select the field “Temperature” and enter the desired temperature setpoint.  
Setting range: -50 °C up to 180 °C. Confirm entry with **Confirm** icon.
- Select the field “Humidity” and enter the desired humidity setpoint.  
Setting range: 0% r.H. up to 100% r.H. Confirm entry with **Confirm** icon.
- Select the field “Fan” and enter the desired fan speed setpoint.  
Setting range: 30% up to 100% fan speed. Confirm entry with **Confirm** icon.

	<p>When entering a value outside the setting range, the message: “Value outside of limits! (Min: xxx, Max: xxx)” appears (xxx is a wildcard for the limits of the respective parameter). Press the <b>Confirm</b> icon and repeat the entry with a correct value.</p>
---	---

After completing the settings, press the **Confirm** icon to take over the entries and exit the menu, **or** press the **Close** icon to exit the menu without taking over the entries.

## 7.2 Direct setpoint entry via Normal display

Alternatively you can also enter the setpoints directly via Normal display.

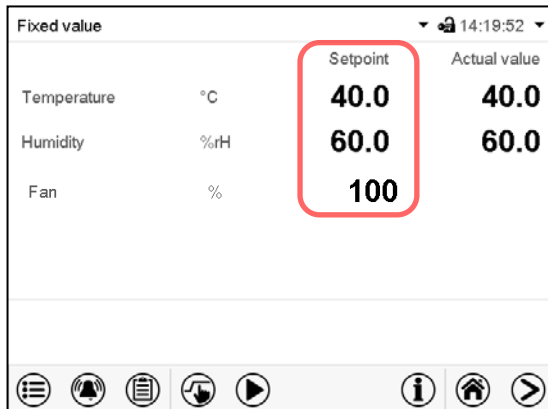

Normal display.

Select the setpoint you want to change.

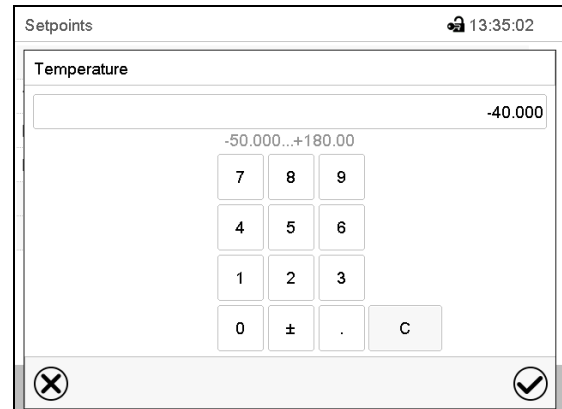

Example: "Temperature" entry menu.

Enter the desired setpoint and confirm entry with **Confirm** icon

## 7.3 Special controller functions via operation lines



Press the **Setpoint setting** icon to access the "Setpoint" setting menu from Normal display.

You can define the switching state of up to 16 operation lines (control contacts). They are used to activate / deactivate special controller functions.

- Operation line "Humidity off" serves to turn off the humidity.
- Operation line "Idle mode" activates / deactivates the operating mode "Idle mode".
- Operation lines "Switching output 1" up to "4" can be used to turn on and off any equipment connected to the zero-voltage switching outputs (DIN sockets (7) and (8) (chap. 20).
- MKF/MKFT 115, 240, 720: Operation line "Compr. air dryer" serves to activate the compressed air dryer (option, chap. 21.6).
- Operation line "Compressed air valve" serves to open the solenoid valve of the compressed air connection (for options compressed air connection, chap. 21.5, or compressed air dryer, chap. 21.6)
- Operation line "Anti-condensation" serves to switch the anti-condensation protection (chap. 19).

The other operation lines are without function.

Use the “Setpoints” menu to configure the operation lines.

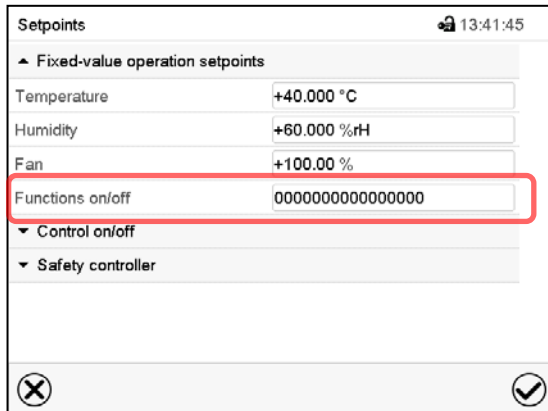

“Setpoints” menu.  
Select the field “Functions on/off”.

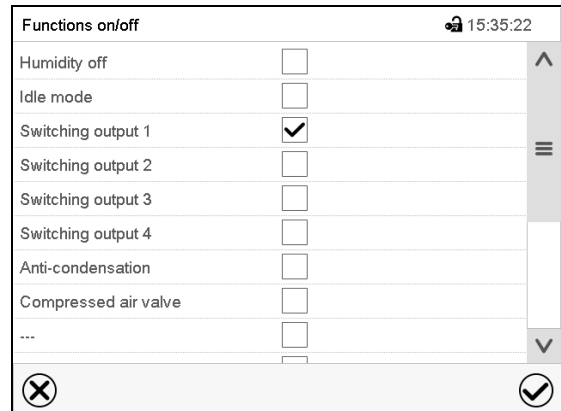

“Functions on/off” entry menu (example: MKF 56).

Mark / unmark the checkbox to activate / deactivate the desired function and press the **Confirm** icon

Activated operation line: switching status “1” (On)

Deactivated operation line: switching status “0” (Off)

The operation lines count from right to left.

**Example:**

Activated operation line “Humidity off” = 0000000000000001

Deactivated operation line “Humidity off” = 0000000000000000

## 8. Timer program: stopwatch function

During an entered duration the controller constantly equilibrates to the setpoints entered in Fixed value operation mode (temperature, humidity, fan speed, configuration of the operation lines). This duration can be entered as a “Timer program”. During the program runtime, any setpoint changes do not become effective; the controller equilibrates to the values which were active during program start.

### 8.1 Starting a timer program

In Normal display press the **Program start** icon to access the “Program start” menu.

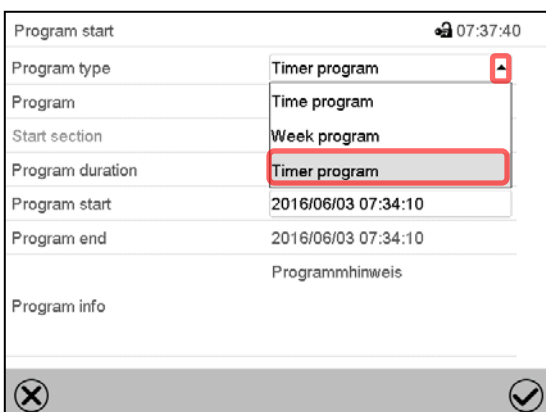

“Program start” menu

- In the field “Program type” select “Timer program”.
- Select the field “Program duration” and enter the desired program duration. Press the **Confirm** icon.
- Select the field “Program start” and enter the desired start time of the program in the “Program start” entry menu. Press the **Confirm** icon. The program delay time until program start begins.

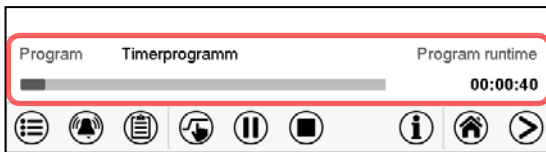

Normal display.

Information on the bottom of the screen indicates the currently running program and the time already passed. The grey bar shows how much time of the whole time is elapsed.

### 8.1.1 Performance during program delay time

During the configured program delay time until program start, the controller equilibrates to the current setpoints of Fixed value operation mode. Modifications of these setpoints are possible but become effective only after the timer program is finished. When the configured moment for program start is reached, the program delay time ends and the program starts running. The controller equilibrates to the values which had been active during program start.



## 8.2 Stopping a running timer program

### 8.2.1 Pausing a running timer program

	Press the <b>Program pause</b> icon to interrupt the program.
---	---

The program is paused. The program runtime stops running down, the time display flashes.

There are the following options:

	Press the <b>Program start</b> icon to continue the program
	Press the <b>Cancelling</b> icon to cancel the program

### 8.2.2 Cancelling a running timer program

	Press the <b>Program cancelling</b> icon to cancel the program.
---	---

A confirmation prompt is displayed. Press the **Confirm** icon to confirm that the program shall really be cancelled.

After confirming the message the controller changes to Fixed value operation mode. Temperature and humidity will then equilibrate to the setpoints of Fixed value operation mode.

## 8.3 Performance after the end of the program

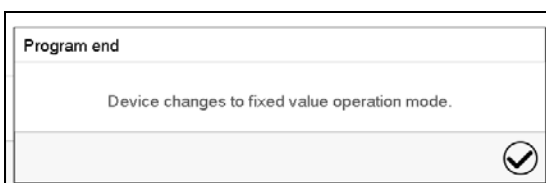

After the end of the program the message “Device changes to fixed value operation mode” appears on the screen.

Press the **Confirm** icon.

After confirming the message the controller changes to Fixed value operation mode. Temperature and humidity will then equilibrate to the setpoints of Fixed value operation mode.

## 9. Time programs

The MB2 program controller permits programming time programs with real-time reference. It offers 25 program memory positions with up to 100 program sections each.

For each program section you can enter a temperature set-point, the humidity set-point, the fan speed, section duration, type of temperature and humidity transition (ramp or step) and the tolerance range.

	If the safety controller has been set to "limit" mode, check the setting of the safety controller when changing the temperature set-point (chap. 12.2).
---	---

	Reduce the fan speed only if required, because the spatial distribution of temperature and humidity will also be reduced. <b>Technical data refers to 100% fan speed.</b>
---	--

Programming remains saved in case of a power failure or after turning off the unit.

Path: [Main menu](#) > [Programs](#) > [Time program](#)

### 9.1 Starting an existing time program

	In Normal display press the <b>Program start</b> icon to access the "Program start" menu.
---	---

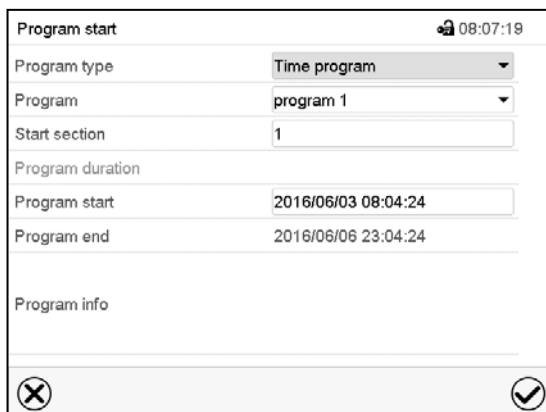

"Program start" menu

- In the field "Program type" select the setting "Time program".
- In the field "Program" select the desired program.
- Select the field "Program start" and enter the desired program start time in the "Program start" entry menu. Press the **Confirm** icon. The program delay time until program start begins.

The program end is adapted automatically depending on the entered program duration.

After completing the settings, press the **Confirm** icon to take over the entries and exit the menu. The program starts running.

If instead you press the **Close** icon to exit the menu without taking over the entries, the program will not start.



Normal display. Information on the bottom of the screen indicates the currently running program and the time already passed. The grey bar shows how much time of the whole time is elapsed. If program duration has been set to infinite, the grey bar is not displayed.

### 9.1.1 Performance during program delay time

During the configured program delay time until program start, the controller equilibrates to the current setpoints of Fixed value operation mode. Modifications of these setpoints are effective. When the configured moment for program start is reached, the program delay time ends and the program starts running.



## 9.2 Stopping a running time program

### 9.2.1 Pausing a running time program

	Press the <b>Program pause</b> icon to interrupt the program.
---	---

The program is paused. The program runtime stops running down, the time display flashes.

There are the following options:

	Press the <b>Program start</b> icon to continue the program
	Press the <b>Cancelling</b> icon to cancel the program

### 9.2.2 Cancelling a running time program

	Press the <b>Program cancelling</b> icon to cancel the program.
---	---

A confirmation prompt is displayed. Press the **Confirm** icon to confirm that the program shall really be cancelled.

After confirming the message, the controller changes to Fixed value operation mode. Temperature and humidity will then equilibrate to the setpoints of Fixed value operation mode.

## 9.3 Performance after the end of the program

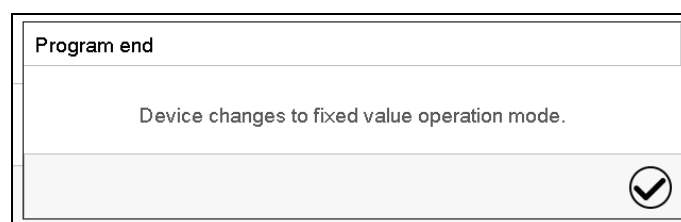

After the end of the program the message "Device changes to fixed value operation mode" appears on the screen.

Press the **Confirm** icon.

As long as the message has not been confirmed, the setpoint of the last program section remains effective. Program the last section as desired. If e.g. heating, refrigeration, humidification and dehumidification shall turn off, activate operation line "Idle mode" in the last program section.

After confirming the message the controller changes to Fixed value operation mode. Temperature and humidity will then equilibrate to the setpoints of Fixed value operation mode.

## 9.4 Creating a new time program

Path: [Main menu](#) > [Programs](#) > [Time program](#)

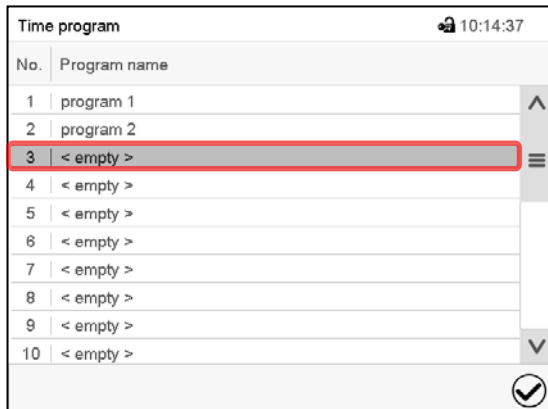

“Time program” menu:  
overview of the existing programs.  
Select an empty program place.

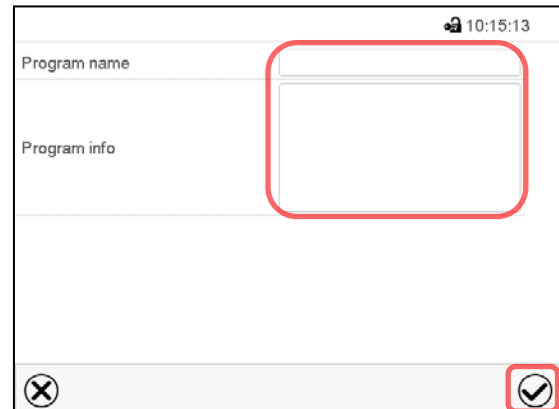

Enter the program name and, if desired, additional program information in the corresponding fields.

Press the **Confirm** icon.

The program view opens (chap. 9.5).

## 9.5 Program editor: program management

Path: [Main menu](#) > [Programs](#) > [Time program](#)

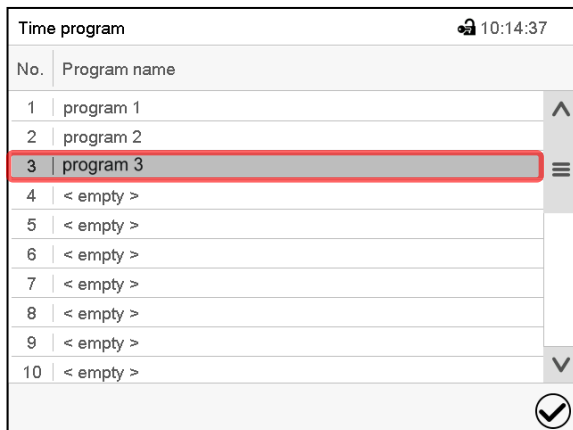

“Time program” menu:  
overview of the existing programs.  
Select an existing program (example: program 3) or create a new program (chap. 9.4).  
The program view opens.

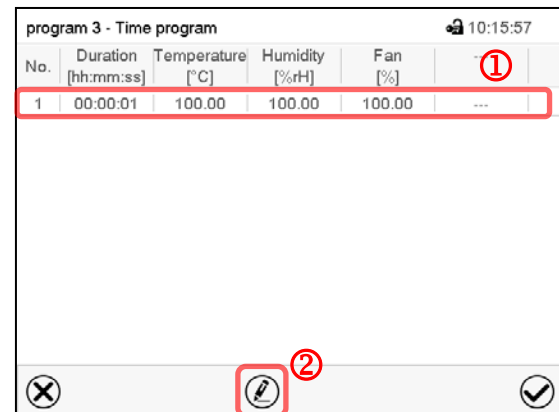

Program view (example: program 3).

If a new program has been created, there is just one program section.

There are the following options:

- ① Select a program section to open the section editor (chap. 9.6)
- ② Press the **Edit** icon to open the program editor



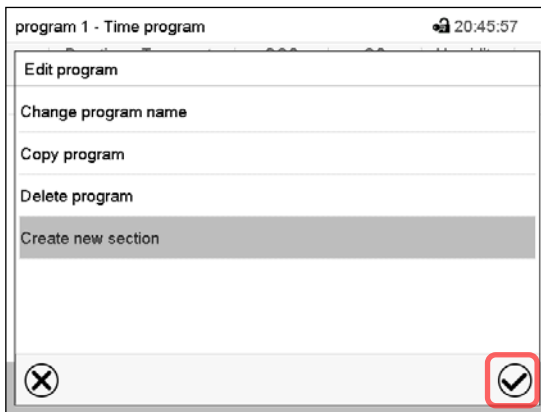

Program editor: "Edit program" menu

Select the desired function and press the **Confirm** icon.

The program editor offers following options:

- Change the program name
- Copy program
- Replace program: Replacing an new or an existing program with the copied program. This menu point is visible only after a program has been copied.
- Delete program
- Create new section

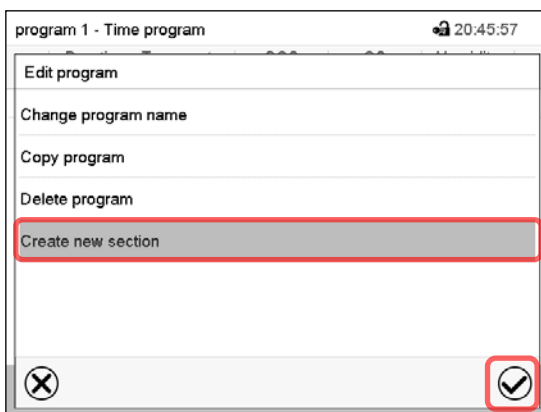

To add a new section, select "Create new section" and press the **Confirm** icon.

The program view opens.

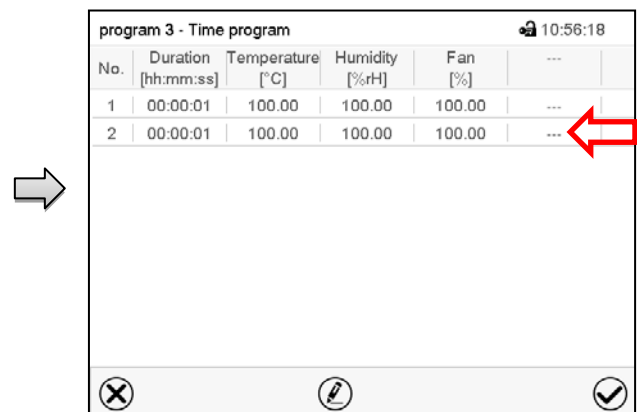

Program view.

A new section is always added at the very bottom (example: section 2).

### 9.5.1 Deleting a time program

Path: [Main menu](#) > [Programs](#) > [Time program](#)

In the "Time program" menu select the program to be deleted. The program view opens.



In the **program view** press the **Edit** icon to open the program editor



In the **program editor** select "Delete program" and press the **Confirm** icon.

The program is deleted. The controller returns to the program view.

## 9.6 Section editor: section management

Path: [Main menu](#) > [Programs](#) > [Time program](#)

Select the desired program.

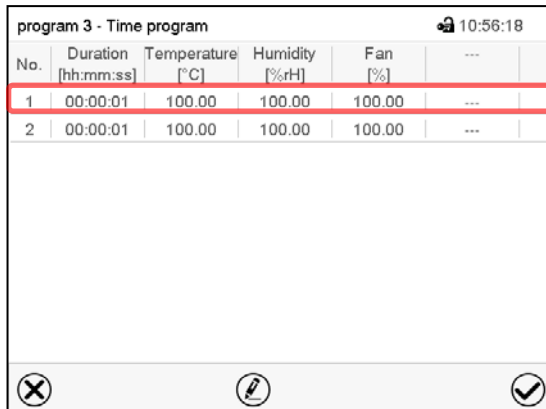

No.	Duration [hh:mm:ss]	Temperature [°C]	Humidity [%RH]	Fan [%]	...
1	00:00:01	100.00	100.00	100.00	...
2	00:00:01	100.00	100.00	100.00	...

Program view.

Select the desired program section  
(example: section 1)

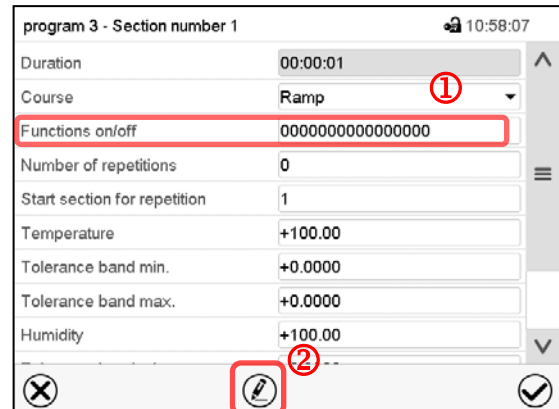
Section view (example: section 1).

There are the following options:

- ① Select a parameter to enter or modify the according value (chap. 9.7)
- ② Press the **Edit** icon to open the program editor

Section editor: "Edit section" menu

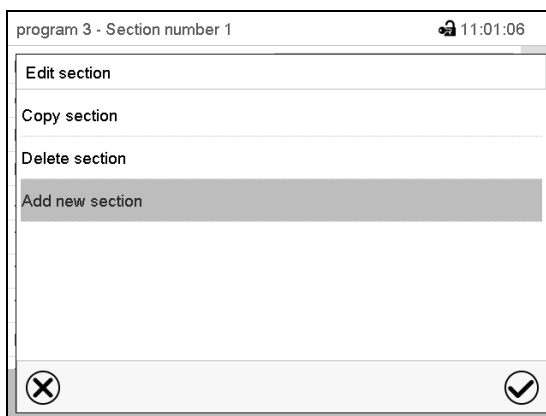
Select the desired function and press the **Confirm** icon.

The section editor offers following options:

- Copy section
- Replace section: Replacing an existing section with the copied section. This menu point is visible only after a section has been copied.
- Insert section: Adding the copied section. This menu point is visible only after a section has been copied.
- Delete section
- Add new section

### 9.6.1 Add a new program section

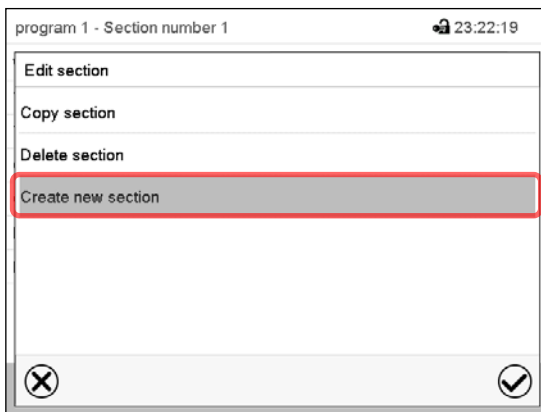

Section editor: “Edit section” menu.

Select “Create new section” and press the **Confirm** icon.

Then select whether to insert the new section before or after the current section.

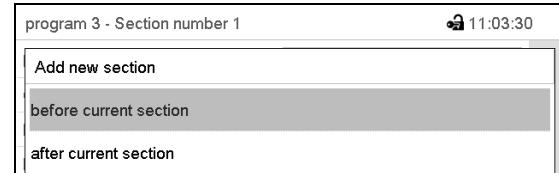

Press the **Confirm** icon. The new section opens.

### 9.6.2 Copy and insert or replace a program section

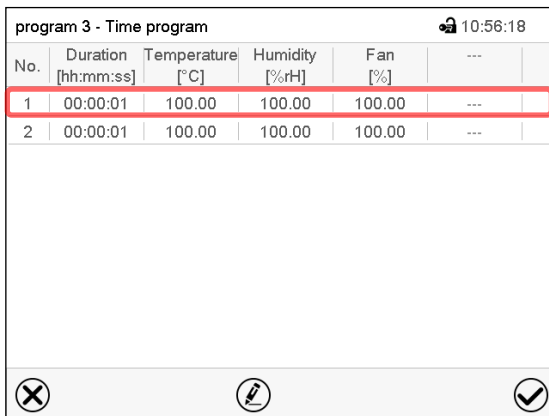

Program view.

Select the program section to be copied (example: section 1)

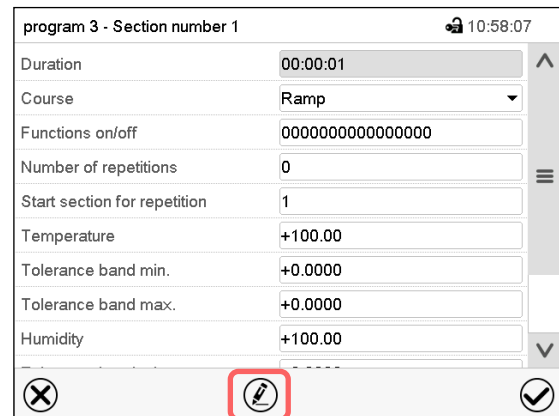

Section view (example: section 1).

Press the **Edit** icon to open the section editor.

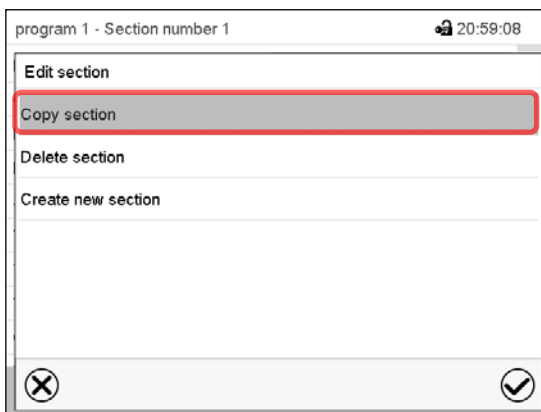

Section editor: “Edit section” menu

Select “Copy section” and press the **Confirm** icon.

The current section (example: section 1) is copied.

The controller returns to the section view.

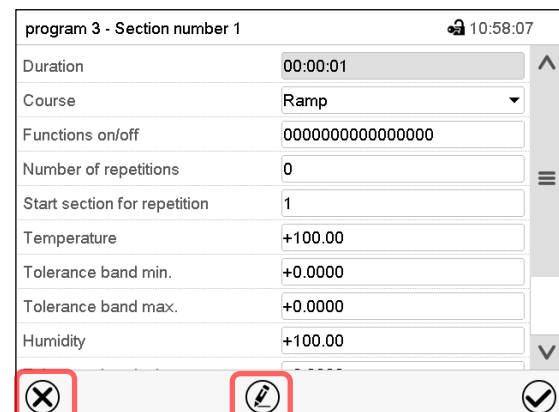

Section view (example: section 1).

Press the **Close** icon to change to the program view, if you want to select another section to be replaced or before or after which the copied section shall be inserted...

or

Press the **Edit** icon to open the section editor if you want the current section to be replaced or the copied section to be inserted before or after it

No.	Duration [hh:mm:ss]	Temperature [°C]	Humidity [%rH]	Fan [%]	...
1	00:00:01	100.00	100.00	100.00	...
2	00:00:01	100.00	100.00	100.00	...

Program view.

Select the section to be replaced or before or after which the copied section shall be inserted (example: section 2) and press the **Confirm** icon.



Duration	00:00:01
Course	Ramp
Functions on/off	0000000000000000
Number of repetitions	0
Start section for repetition	1
Temperature	+100.00
Tolerance band min.	+0.0000
Tolerance band max.	+0.0000
Humidity	+100.00

Section view (example: section 1).

Press the **Edit** icon to open the section editor



- Edit section
- Copy section
- Replace section
- Insert section
- Delete section
- Create new section

Section editor: "Edit section" menu

Select "Replace section" to replace the selected section with the copied section

or

Select "Insert section" to additionally add the copied section.

In this case select whether to insert it before or after the selected section.

- Insert section
- before current section
- after current section

Press the **Confirm** icon

### 9.6.3 Deleting a program section

In the **program view** select the program section to be deleted. The section view opens.



In the **section view** press the **Edit** icon to open the section editor



In the **section editor** select "Delete section" and press the **Confirm** icon.  
The section is deleted. The controller returns to the section view.

## 9.7 Value entry for a program section

Path: [Main menu > Programs > Time program](#)

Select the desired program and section.

The section view gives access to all parameters of a program section. You can enter or modify the values.

	<table border="1"> <tr> <th colspan="2">Program name and section number</th> </tr> <tr> <td>Section duration</td> <td></td> </tr> <tr> <td>Type of setpoint transition: ramp or step</td> <td></td> </tr> <tr> <td>Operation lines</td> <td></td> </tr> <tr> <td colspan="2">Repeating one or several sections within a program</td> </tr> <tr> <td>Temperature setpoint</td> <td></td> </tr> <tr> <td colspan="2">Temperature tolerance range: minimum and maximum</td> </tr> <tr> <td>Humidity setpoint</td> <td></td> </tr> <tr> <td colspan="2">Humidity tolerance range: minimum and maximum</td> </tr> <tr> <td>Fan speed</td> <td></td> </tr> </table>	Program name and section number		Section duration		Type of setpoint transition: ramp or step		Operation lines		Repeating one or several sections within a program		Temperature setpoint		Temperature tolerance range: minimum and maximum		Humidity setpoint		Humidity tolerance range: minimum and maximum		Fan speed	
Program name and section number																					
Section duration																					
Type of setpoint transition: ramp or step																					
Operation lines																					
Repeating one or several sections within a program																					
Temperature setpoint																					
Temperature tolerance range: minimum and maximum																					
Humidity setpoint																					
Humidity tolerance range: minimum and maximum																					
Fan speed																					

The setting and control ranges for the individual parameters are the same as for “Fixed value” operating mode (chap. 7).

### 9.7.1 Section duration

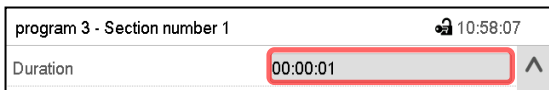

Section view (partial view).  
Select the field “Duration” indicating the time.

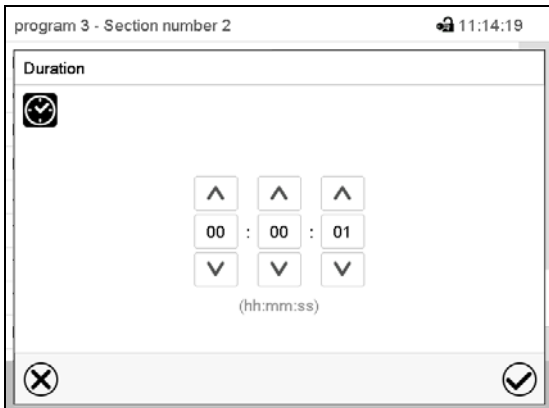

“Duration” entry menu.  
Enter the desired section duration with the arrow keys and press the **Confirm** icon.  
Setting range: 0 up to 99 hours 59 min 59 sec.

## 9.7.2 Set-point ramp and set-point step

You can define the type of temperature and humidity transitions for each individual program section.

### “Ramp” mode: Gradual changes of temperature and humidity

The set-point of a given program section functions as the section’s start temperature. During the section’s duration, the set-point gradually passes to the set-point of the subsequent program section. The actual value follows the continually changing set-point.

If the last program section is in “ramp” mode and the setpoint shall change within this section, then you must program an additional section (with the shortest possible section duration) to provide the target temperature of the last program section. Otherwise, the setpoint would remain constant during the section’s duration.

Programming in the “ramp” mode allows all kinds of temperature and humidity transitions:

- Gradual changes of temperature and humidity  
The setpoint changes its value gradually during the entered section duration. The actual value follows the continually moving set-point at any time.
- Program sections with constant temperature and humidity  
The setpoints (initial values) of two subsequent program sections are identical; so the temperature and humidity remain constant during the entire duration of the first program section.
- Sudden changes of temperature and humidity  
Steps can be programmed in ramp mode as temperature or humidity changes (ramps) that occur during a very short interval. If the duration of this transitional program section is very short (minimum entry 1 sec), the temperature or humidity change will proceed rapidly within the minimum amount of time.

### “Step” mode: Sudden changes of temperature and humidity

The set-point of any program section functions as the section’s target value. At the start of the program section, the unit heats up or cools down and humidifies/dehumidifies the chamber with the maximum speed to reach the entered value; and then it holds it for the remaining section time. Therefore the set-point temperature remains constant for the section’s duration. These changes occur rapidly within the minimum amount of time (minimum entry: 1 second).

Programming in the “step” mode allows only two kinds of temperature and humidity transitions:

- Programming gradual changes of temperature and humidity (ramps) is impossible in the “step” mode
- Program sections with constant temperature and humidity  
The setpoints (target values) of two subsequent program sections are identical; so the temperature and humidity remain constant during the entire duration of the first program section.
- Sudden changes of temperature and humidity  
The entered setpoint of the section is reached as fast as possible and then held constant for the remaining section duration.

### Selecting the setting “Ramp” or “Step”

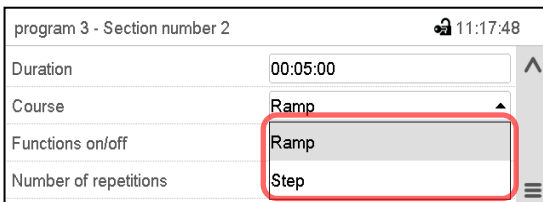

The screenshot shows a control interface for 'program 3 - Section number 2' at 11:17:48. It features a table with the following fields: Duration (00:05:00), Course (Ramp), Functions on/off (Ramp), and Number of repetitions (Step). A red box highlights the 'Course' dropdown menu, which is currently set to 'Ramp' and has 'Step' as an alternative option.

Section view (partial view).  
In the field “Course” select the desired setting “Ramp” or “Step”.

### “Ramp” and “Step” mode example (representation of a temperature course)

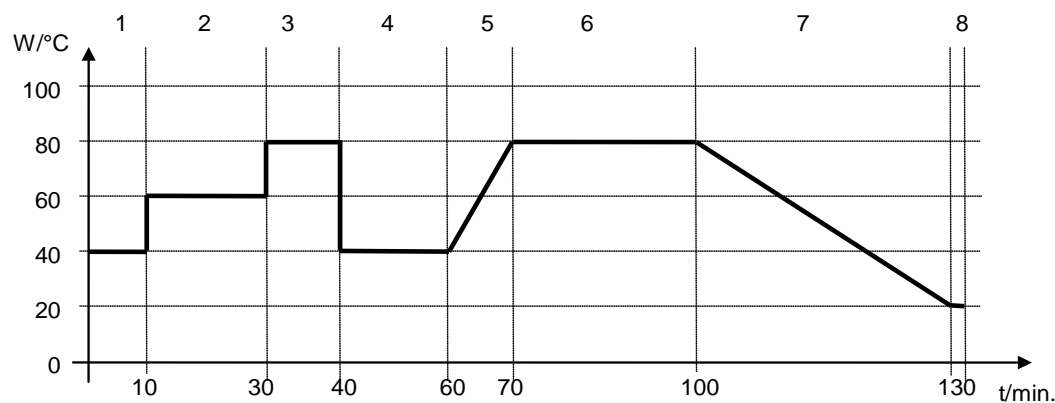

#### Corresponding program table

Section No.	Duration [hh:mm:ss]	Temperature [°C]	Humidity [% rH]	Fan [%]	Ramp or Step
1	00:10:00	40.0	xxxx	xxxx	Step
2	00:20:00	60.0	xxxx	xxxx	Step
3	00:10:00	80.0	xxxx	xxxx	Step
4	00:20:00	40.0	xxxx	xxxx	Step
5	00:10:00	40.0	xxxx	xxxx	Ramp
6	00:30:00	80.0	xxxx	xxxx	Ramp
7	00:30:00	80.0	xxxx	xxxx	Ramp
8	00:00:01	20.0	xxxx	xxxx	Ramp

### 9.7.3 Special controller functions via operation lines

You can define the switching state of up to 16 operation lines (control contacts). They are used to activate / deactivate special controller functions.

- Operation line “Humidity off” serves to turn off the humidity.
- Operation line “Idle mode” activates / deactivates the operating mode “Idle mode”.
- Operation lines “Switching output 1” up to “4” can be used to turn on and off any equipment connected to the zero-voltage switching outputs (DIN sockets (7) and (8) (chap. 20).
- MKF/MKFT 115, 240, 720: Operation line “Compr. air dryer” serves to activate the compressed air dryer (option, chap. 21.6).
- Operation line “Compressed air valve” serves to open the solenoid valve of the compressed air connection (for options compressed air connection, chap. 21.5, or compressed air dryer, chap. 21.6)
- Operation line “Anti-condensation” serves to switch the anti-condensation protection (chap. 19).

The other operation lines are without function.

Use the Section editor to configure the operation lines.

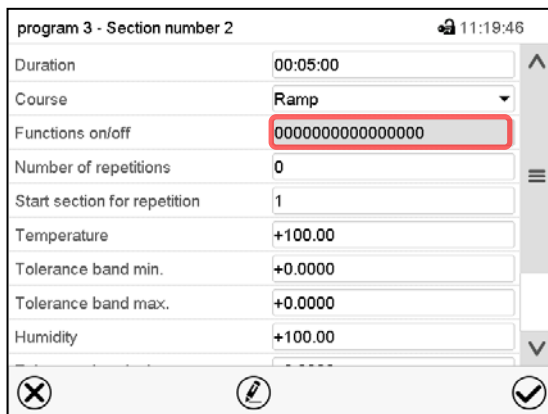

program 3 - Section number 2 11:19:46

Duration 00:05:00

Course Ramp

Functions on/off 0000000000000000

Number of repetitions 0

Start section for repetition 1

Temperature +100.00

Tolerance band min. +0.0000

Tolerance band max. +0.0000

Humidity +100.00

Section view.

Select the field "Functions on/off".

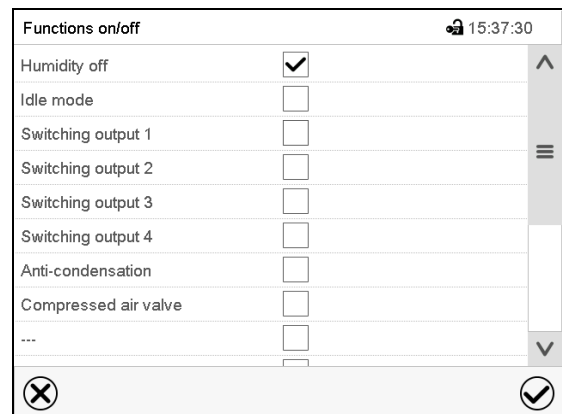
Functions on/off 15:37:30

Humidity off

Idle mode

Switching output 1

Switching output 2

Switching output 3

Switching output 4

Anti-condensation

Compressed air valve

...

"Functions on/off" entry menu.

Mark / unmark the checkbox of the desired function to activate / deactivate it and press the **Confirm** icon.



The controller returns to the section view.

Activated operation line: switching status "1" (On)

Deactivated operation line: switching status "0" (Off)

The operation lines count from right to left.

#### Example:

Activated operation line "Humidity off" = 0000000000000000**1**

Deactivated operation line "Humidity off" = 0000000000000000**0**

### 9.7.4 Setpoint entry

- Select the field "Temperature" and enter the desired temperature setpoint.  
Setting range: -50 °C up to 180 °C.  
Confirm entry with **Confirm** icon. The controller returns to the section view.
- Select the field "Humidity" and enter the desired humidity setpoint.  
Setting range: 0% r.H. up to 100% r.H.  
Confirm entry with **Confirm** icon. The controller returns to the section view.
- Select the field "Fan" and enter the desired fan speed setpoint.  
Setting range: 30% up to 100% fan speed.  
Confirm entry with **Confirm** icon. The controller returns to the section view.



### 9.7.5 Tolerance range

You can specify a temperature and humidity program tolerance range for each program section with different values for the tolerance minimum and maximum. When the actual value exceeds the given threshold, the program is interrupted. This is indicated on the display (see below). When the actual temperature is situated again within the entered tolerance limits, the program automatically continues. Therefore, the duration of the program may be extended due to the programming of tolerances.



Programming of tolerances may extend program duration.

An entry of “-99999” for the tolerance minimum means “minus infinite” and an entry of “999999” for the tolerance maximum means “plus infinite”. Entry of these values will never lead to program interruption. The entry of “0” for the tolerance minimum and/or maximum deactivates the respective tolerance function.

When requesting rapid value transitions, we recommend not programming tolerance values in order to enable the maximum heating-up, cooling-down, humidification or dehumidification speed.

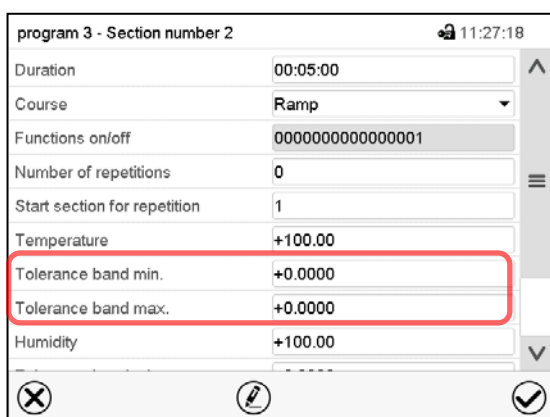

Section view, showing the temperature tolerance band

- Select the field “Tolerance band min” and enter the desired lower tolerance band value. Setting range: -99999 to 99999. Confirm entry with **Confirm** icon. The controller returns to the section view.
- Select the field “Tolerance band max” and enter the desired upper tolerance band value. Setting range: -99999 to 99999. Confirm entry with **Confirm** icon. The controller returns to the section view.

Set the tolerance ranges for other parameters accordingly, if desired.

If one of the actual values (temperature and/or humidity) is outside the program tolerance range the whole program course is interrupted. During this program interruption time the controller equilibrates to the set-points of the current section.

The screen header indicates “Program pause (tolerance band)”. The program runtime indication flashes and does not proceed any further.

When the temperature or humidity values are back within the entered program tolerance range, the program continues automatically.

### 9.7.6 Repeating one or several sections within a time program

You can repeat several subsequent sections together. It is not possible to define the start section the same time also as the target section, therefore you cannot repeat a single individual section.

Enter the desired number of repetitions in the field „Number of repetitions“ and the number of the section to start the repetition cycle with in the field “Start section for repetition” To have sections repeated infinitely, enter the number of repetitions as “-1”.

The selected sections are repeated as many times as selected. Then the program continues.

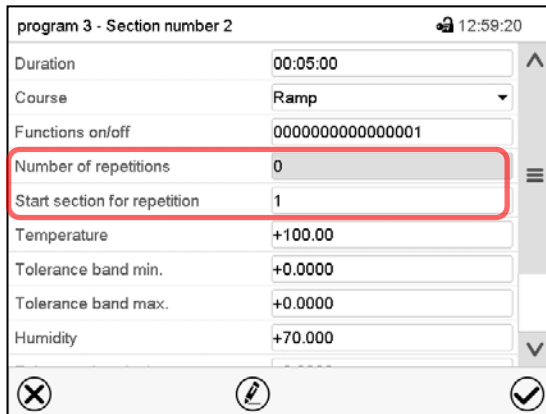

Section view, showing the repetition function.

- Select the field “Number of repetitions” and enter the desired number of repetitions. Setting range: 1 to 99, and -1 for infinite. Confirm entry with **Confirm** icon. The controller returns to the section view.
- Select the field “Start section for repetition” and enter the section number, at which the repetition should start. Setting range: 1 up to the section before the currently selected section. Confirm entry with **Confirm** icon. The controller returns to the section view.

### 9.7.7 Saving the time program

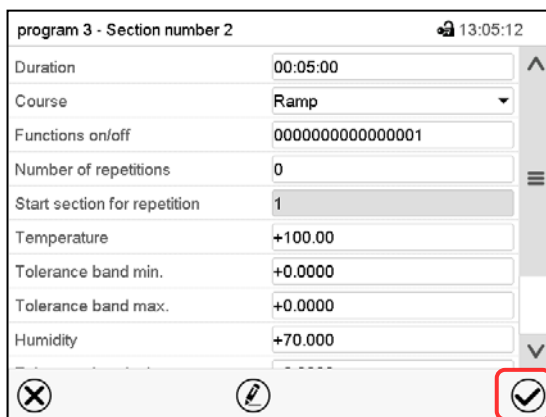

Section view.

After the all desired values of the program section have been configured, press the **Confirm** icon to take over the programming. The controller changes to the program view.

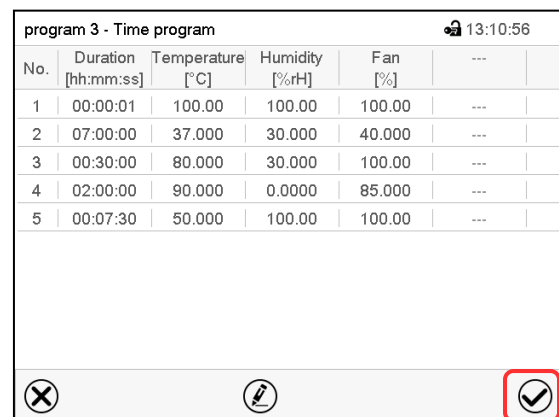

Program view.

Press the **Confirm** icon to take over the programming. The controller changes to the Normal display.



To save the programming it is absolutely required to press the **Confirm** icon. Otherwise all settings will be lost! There is no confirmation prompt!

## 10. Week programs

The MB2 program controller permits programming week programs with real-time reference. It offers 5 week program places in total with up to 100 shift points for each week program.

Path: [Main menu](#) > [Programs](#) > [Week program](#)

### 10.1 Starting an existing week program

 In Normal display press the **Program start** icon to access the “Program start” menu.

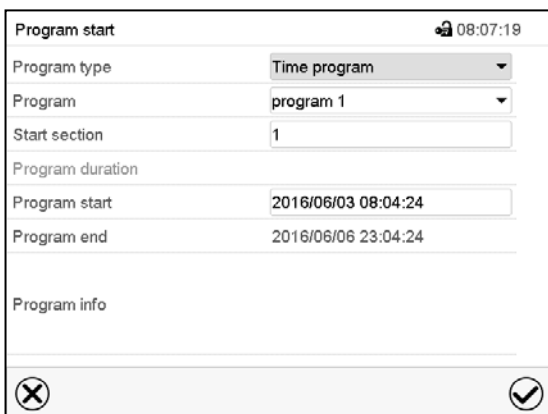

“Program start” menu.

- In the field “Program type” select the setting “Week program”.
- In the field “Program” select the desired program.
- There are no further settings available in the “Program start” menu for week programs, as they are needed only for time programs.

After completing the settings, press the **Confirm** icon to take over the entries and exit the menu. The program starts running.

If instead you press the **Close** icon to exit the menu without taking over the entries, the program will not start.

After starting the week program, the previously entered week program setpoints are active and will be equilibrated according to the current time.

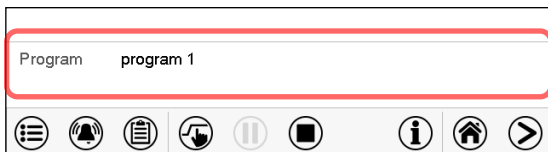

Information on the bottom of the screen indicates the currently running program.

### 10.2 Cancelling a running week program

 Press the **Program cancelling** icon to cancel the program.

A confirmation prompt is displayed. Press the **Confirm** icon to confirm that the program shall really be cancelled.

After confirming the message the controller changes to Fixed value operation mode. Temperature and humidity will then equilibrate to the setpoints of Fixed value operation mode.

### 10.3 Creating a new week program

Path: *Main menu > Programs > Week program*

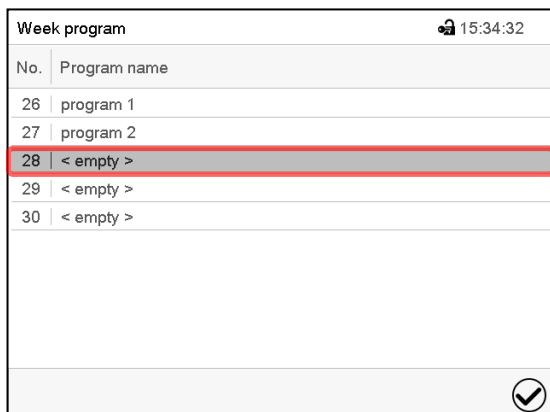

“Week program” menu:  
overview of the existing programs.  
Select an empty program place.

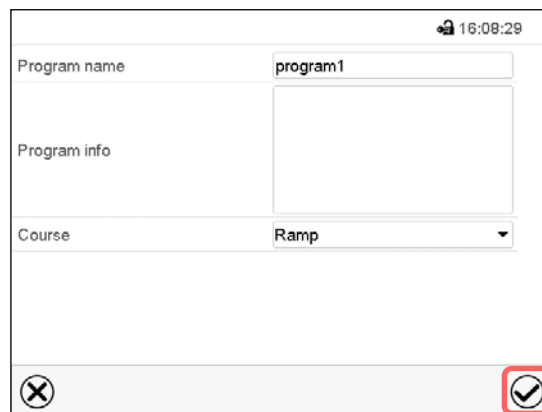

Enter the program name and, if desired, additional program information in the corresponding fields.

Select the set-point course “Ramp” or “Step” (chap. 10.6.1).

Press the **Confirm** icon. The program view opens.

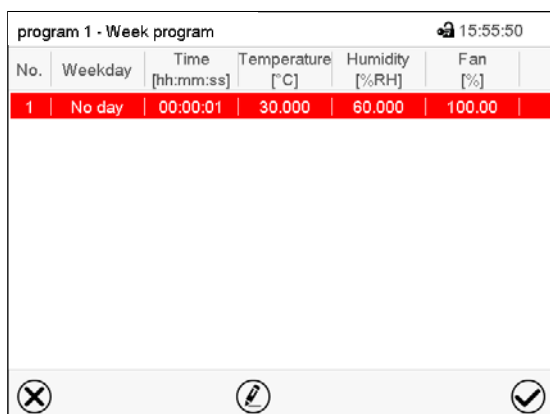

Program view.

For the first section no weekday is specified. Therefore the section is first marked in red and cannot be saved.

## 10.4 Program editor: program management

Path: [Main menu](#) > [Programs](#) > [Week program](#)

No.	Program name
26	program 1
27	program 2
28	< empty >
29	< empty >
30	< empty >

“Week program” menu:  
overview of the existing programs.  
Select an existing program  
(example: program 1).



No.	Weekday	Time [hh:mm:ss]	Temperature [°C]	Humidity [%RH]	Fan [%]
1	Monday	07:30:00	40.000	75.000	100.00
2	Tuesday	15:00:00	30.000	60.000	100.00

Program view (example: program 1).  
If a new program has been created, there is just one program section.

There are the following options:

- ① Select a program section to open the section editor (chap. 10.5)
- ② Press the **Edit** icon to open the program editor



Edit program	
Change program name	
Copy program	
Delete program	
Add new section	

Program editor: “Edit program” menu.  
Select the desired function and press the **Confirm** icon.

The program editor offers following options:

- Change program name. This menu also offers to configure the ramp / step mode setting (chap. 10.6.1).
- Copy program
- Replace program: Replacing an new or an existing program with the copied program. This menu point is visible only after a section has been copied.
- Delete program
- Add new section

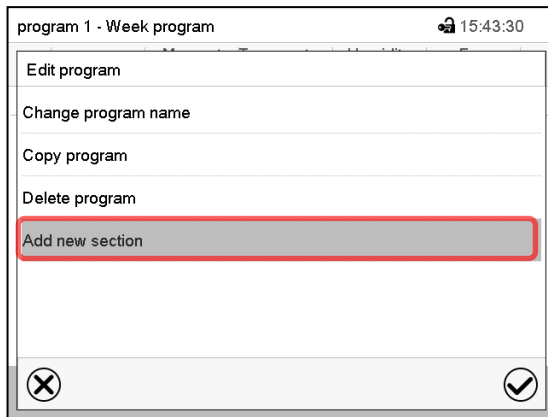

To add a new section, select “Add new section” and press the **Confirm** icon.  
The program view opens.

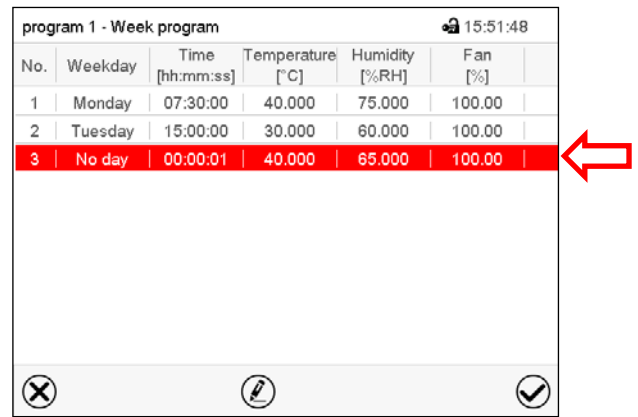

Program view.

With a new section no weekday is specified. Therefore the section is first marked in red and cannot be saved.

A new section is always added at the very bottom (example: section 3). When the section start is specified the sections are automatically arranged in the correct chronological order.

#### 10.4.1 Deleting a week program

Path: [Main menu > Programs > Week program](#)

In the “Week program” menu select the program to be deleted. The program view opens.



In the **program view** press the **Edit** icon to open the program editor



In the **program editor** select “Delete program” and press the **Confirm** icon.  
The program is deleted. The controller returns to the program view.

## 10.5 Section editor: section management

Path: [Main menu](#) > [Programs](#) > [Week program](#)

Select the desired program.

No.	Weekday	Time [hh:mm:ss]	Temperature [°C]	Humidity [%RH]	Fan [%]
1	Monday	07:30:00	40.000	75.000	100.00
2	Tuesday	15:00:00	30.000	60.000	100.00

Program view.

Select the desired program section  
(example: section 1)



program 1 - Section number 1		15:49:36
Weekday	Monday	
Moment	00:00:01	①
Temperature	+100.00	
Humidity	+100.00	
Fan	+100.00	
Functions on/off	0000000000000000	

Section view (example: section 1).

There are the following options:

- ① Select a parameter to enter or modify the according value (chap. 10.6)
- ② Press the **Edit** icon to open the program editor



program 1 - Section number 1		23:22:19
Edit section		
Copy section		
Delete section		
Create new section		

Section editor: "Edit section" menu

Select the desired function and press the **Confirm** icon.

The section editor offers following options:

- Copy section
- Replace section: Replacing an existing section with the copied section. This menu point is visible only after a section has been copied.
- Insert section: Adding the copied section. This menu point is visible only after a section has been copied.
- Delete section
- Create new section

### 10.5.1 Add a new program section

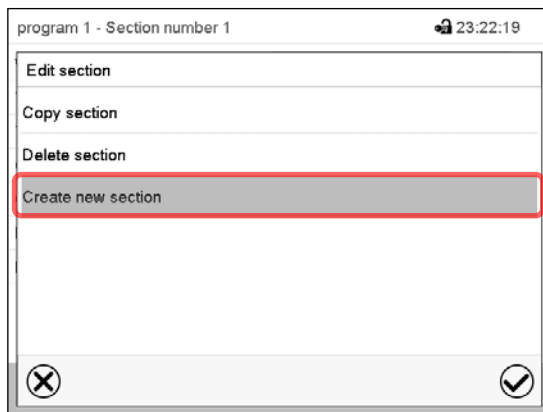

Section editor: "Edit section" menu.

Select "Create new section" and press the **Confirm** icon.



No.	Weekday	Time [hh:mm:ss]	Temperature [°C]	Humidity [%RH]	Fan [%]
1	Monday	07:30:00	40.000	75.000	100.00
2	Tuesday	15:00:00	30.000	60.000	100.00
3	No day	00:00:01	40.000	65.000	100.00

Program view.

With a new section no weekday is specified. Therefore the section is first marked in red and cannot be saved.

A new section is always added at the very bottom (example: section 3). When the section start is specified the sections are automatically arranged in the correct chronological order.

### 10.5.2 Copy and insert or replace a program section

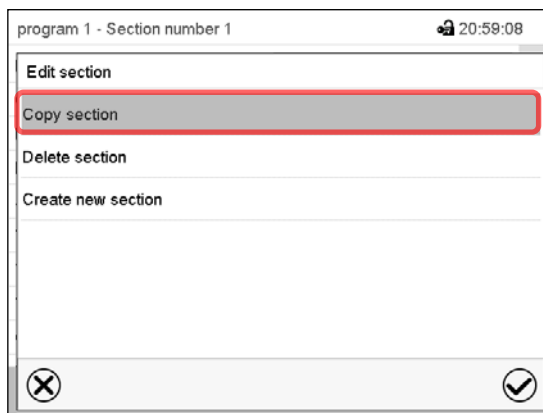

Section editor: "Edit section" menu

Select "Copy section" and press the **Confirm** icon.

The current section (example: section 1) is copied.

The controller returns to the program view.



No.	Weekday	Time [hh:mm:ss]	Temperature [°C]	Humidity [%RH]	Fan [%]
1	Monday	07:30:00	40.000	75.000	100.00
2	Tuesday	15:00:00	30.000	60.000	100.00

Program view

Select the section to be replaced or before or after which the copied section shall be inserted (example: section 2).

Press the **Confirm** icon

The controller returns to the section editor



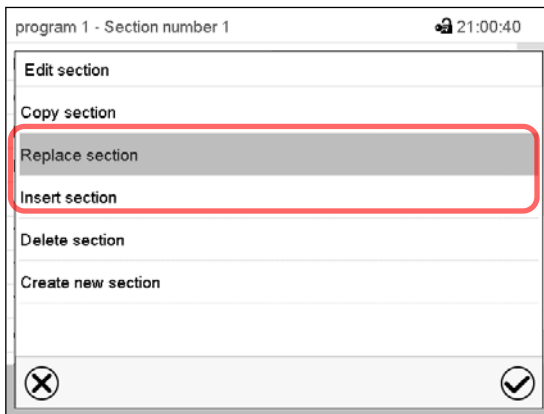

Section editor: "Edit section" menu

Select "Replace section" to replace the selected section with the copied section

or

Select "Insert section" to additionally add the copied section.

Press the **Confirm** icon.

If you selected "Insert section" the sections are automatically arranged in the correct chronological order.

### 10.5.3 Deleting a program section

In the **program view** select the program section to be deleted. The section view opens.

➡ In the **section view** press the **Edit** icon to open the section editor

➡ In the **section editor** select "Delete section" and press the **Confirm** icon.  
The section is deleted. The controller returns to the section view.

## 10.6 Value entry for a program section

Path: [Main menu](#) > [Programs](#) > [Week program](#)

Select the desired program and section.

The setting and control ranges for the individual parameters are the same as for "Fixed value" operating mode (chap. 7).

### 10.6.1 Set-point ramp and set-point step modes

The explanation of the settings "Ramp" or "Step" is given in chap. 9.7.2.

You can define the type of temperature and humidity transitions for the entire week program.

Select the desired program and press the **Edit** icon to open the program editor. In the program editor select the "Change program name" function and press the **Confirm** icon.

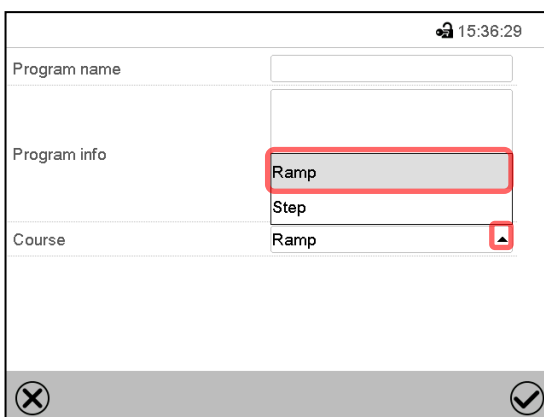

"Change program name" menu.

In the field "Course" select the desired setting "Ramp" or "Step" and press the **Confirm** icon.

### 10.6.2 Weekday

program 1 - Section number 1 🔒 07:51:22

Weekday	Monday
Moment	12:30:30
Temperature	+50.000
Humidity	+80.000
Fan	+50.000
Functions on/off	0000000000000000

✕    ✎    ✓

Section view.

In the field "Weekday" select the desired weekday.

Sunday ^

Monday ≡

Tuesday □

Wednesday v

---

Thursday ^

Friday □

Saturday ≡

Daily v

With "Daily" selected, this section will run every day at the same time.

### 10.6.3 Start time

program 1 - Section number 1 🔒 08:09:38

Weekday	Monday
Moment	12:30:30
Temperature	+50.000
Humidity	+80.000
Fan	+50.000
Functions on/off	0000000000000000

✕    ✎    ✓

Section view.

Select the field "Moment".



program 1 - Section number 1 🔒 08:09:05

Moment

🔒

^    ^    ^

12 : 30 : 30

v    v    v

(hh:mm:ss)

✕    ✓

Entry menu "Moment".

Select with the arrow keys the desired start moment of the section and press the **Confirm** icon.

#### 10.6.4 Setpoint entry

- Select the field “Temperature” and enter the desired temperature setpoint.  
Setting range: -50 °C up to 180 °C.  
Confirm entry with **Confirm** icon. The controller returns to the section view.
- Select the field “Humidity” and enter the desired humidity setpoint.  
Setting range: 0% r.H. up to 100% r.H.  
Confirm entry with **Confirm** icon. The controller returns to the section view.
- Select the field “Fan” and enter the desired fan speed setpoint.  
Setting range: 30% up to 100% fan speed.  
Confirm entry with **Confirm** icon. The controller returns to the section view.

#### 10.6.5 Special controller functions via operation lines

You can define the switching state of up to 16 operation lines (control contacts). They are used to activate / deactivate special controller functions.

- Operation line “Humidity off” serves to turn off the humidity.
- Operation line “Idle mode” activates / deactivates the operating mode “Idle mode”.
- Operation lines “Switching output 1” up to “4” can be used to turn on and off any equipment connected to the zero-voltage switching outputs (DIN sockets (7) and (8) (chap. 20).
- MKF/MKFT 115, 240, 720: Operation line “Compr. air dryer” serves to activate the compressed air dryer (option, chap. 21.6).
- Operation line “Compressed air valve” serves to open the solenoid valve of the compressed air connection (for options compressed air connection, chap. 21.5, or compressed air dryer, chap. 21.6)
- Operation line “Anti-condensation” serves to switch the anti-condensation protection (chap. 19).

The other operation lines are without function.

Select the desired program and section. You can set the operation lines in the “Functions on/off” field.

*For details please refer to chap. 9.7.3.*

## 11. Notification and alarm functions

### 11.1 Notification and alarm messages overview

#### 11.1.1 Notifications

Notifications are indicated by **information icons** displayed in the screen header in Normal display



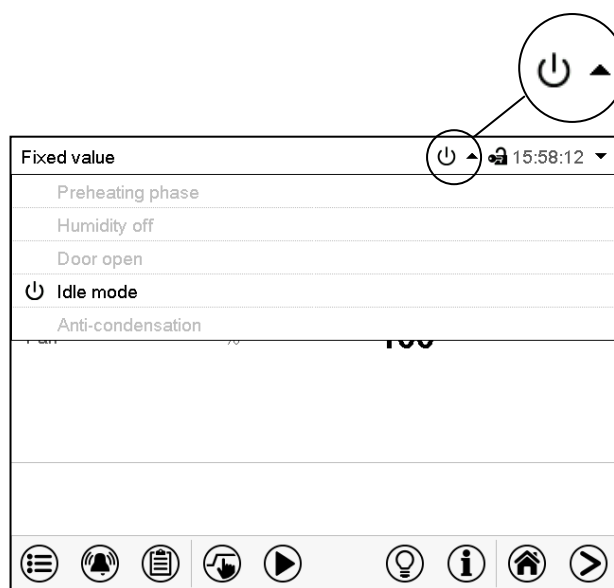

An information icon serves as an indication of a certain condition.

If this condition persists, in some cases an alarm will be triggered after a fix or configurable interval. As long as the condition persists, the information icon therefore continues to be displayed also in state of alarm. If during alarm the conditions ends, e.g., if during a tolerance range alarm the actual value returns to within the tolerance range, the information icon disappears, whereas the alarm will continue until manual acknowledgement.

Press the flash icon next to the information icon to access the corresponding text information.



Normal display showing the text information.  
The currently valid information texts are highlighted in black (example: "Idle mode")

Condition	Information icon	Text information	Start after condition occurred
1-hour preheating phase, no cooling or dehumidification		"Preheating phase"	immediately
The humidification / dehumidification system is turned off (via operation line and/or by setting "Control on/off") <i>or</i> Temperature setpoint below 0 °C or above 95 °C <i>or</i> humidity out of control range. No active humidification of the inner chamber. Cooling operation may cause further dehumidification.		"Humidity off"	immediately
Open chamber door		"Door open"	immediately
The controller is in Idle mode (chap. 5.4).		"Idle mode"	immediately
Operation line "Anti-condensation" on. Anti-condensation protection is activated		"Anti-condensation"	immediately

Condition	Information icon	Text information	Start after condition occurred
<b>MKF/MKFT 115, 240, 720:</b> Operation line "Compr. air dryer" on. Optional compressed air dryer activated. Turn operation line off when not using the compressed air dryer!		"Compressed Air Dryer"	immediately

Notifications are not shown in the event list.

### 11.1.2 Alarm messages

Condition	Alarm message	Start after condition occurred
Chamber door open	"Door open"	after 5 minutes
Exceeded setpoint of the safety controller class 2	"Safety controller"	immediately
Exceeded maximum or minimum temperature (option temperature safety device class 2)	"Temperature safety device"	immediately
Temperature sensor defective	e.g. "- - - -" or "<-<-<" or ">->->"	immediately
Safety controller temperature sensor defective	"Safety controller sensor"	immediately
<b>MKF/MKFT 115, 240, 720:</b> Fault in refrigerating machine. Contact BINDER service.	Compressor overcurrent	immediately

Alarm messages are displayed in the list of active alarms until acknowledging them. They are also shown in the event list.

### 11.1.3 Messages concerning the humidity system

Condition and measures	Message	Start after condition occurred
The humidity module is defective. Contact BINDER service	"Humidity system"	immediately
<b>MKF 56:</b> The humidity module cannot fill up. <i>In case of freshwater supply via water pipe:</i> The water tap is closed, or the chamber is defective (e.g. inlet valve of humidity module). <i>In case of freshwater supply via external freshwater can (option):</i> Water can is empty. Humidification is turned off. In case of refrigerating operation, the interior is strongly dehumidified. When the water supply is functional again, the humidity system restarts, or the chamber is defective.	"Freshwater supply"	immediately
<b>MKF/MKFT 115, 240, 720:</b> Freshwater can is too empty to allow normal function, or the floating switch is defective. The humidification system turns off. Fill up the water can or open the water supply. During the one-hour preheating phase: message without significance.	"Freshwater can empty"	after 60 sec.

Condition and measures	Message	Start after condition occurred
<p><b>MKF/MKFT 115, 240, 720:</b>            Freshwater can is too full, or the floating switch is defective. Suck off the water (chap. 4.2.3). The chamber functions as usual.            If the message persists, contact BINDER service.</p>	<p>“Freshwater can overflow”</p>	<p>after 60 sec.</p>
<p>The humidity module cannot empty the condensate tank.            Wastewater tube obstructed. Check the length and location of the wastewater tube. If appropriate, contact BINDER service.  <i>or</i>            Wastewater pump or floating switch of the wastewater tank defective. Contact BINDER service.</p>	<p>“Wastewater”</p>	<p>immediately</p>
<p>Maintenance of the humidity system is required. Contact BINDER service.</p>	<p>“Humidity module service”</p>	<p>after predefined time (approx. 1 year)</p>

Messages concerning the humidity system are shown in the event list.



When operating the chamber without water connection, turn off humidity control in the “set-points” menu (chap. 6.3) in order to avoid humidity alarms.

## 11.2 State of alarm

1. Visual indications in Normal display: alarm message, screen header flashing in red color
2. Audible alert, if the buzzer is enabled (chap. 11.4).

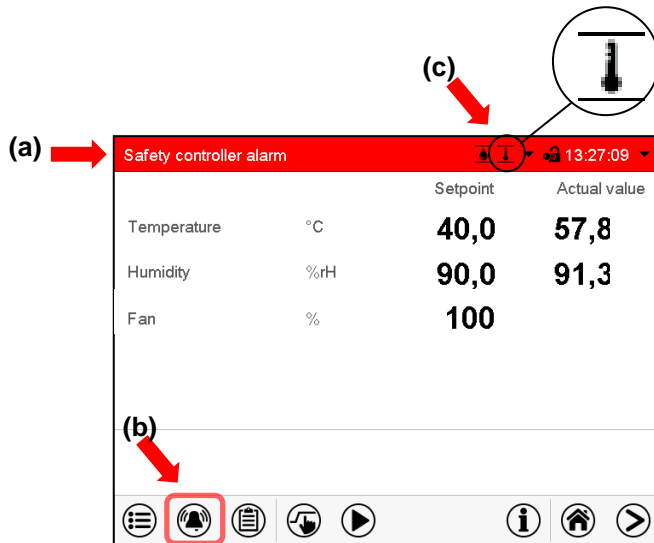

Normal display in state of alarm (example).

(a) Screen header flashing in red color and showing the alarm message

(b) **Alarm** icon on the bottom of the screen: change to the list of active alarms and alarm acknowledgement

(c) If applicable, information icon in the screen header. Indication of a certain condition

## 11.3 Resetting an alarm, list of active alarms

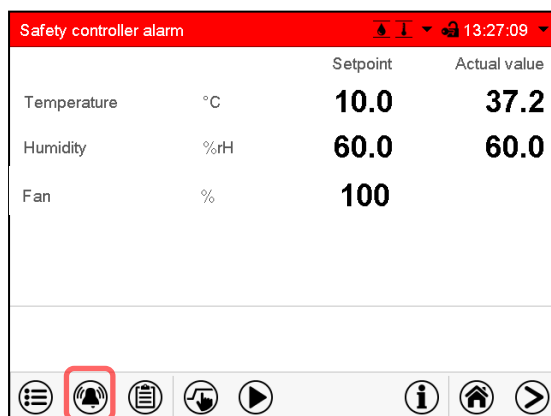

Normal display in state of alarm (example).

Press the **Alarm** icon

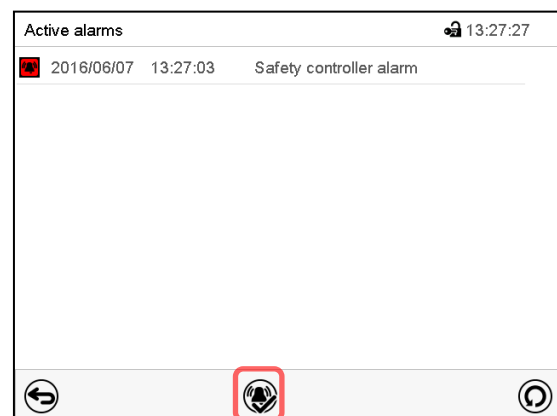

List of active alarms.

Press the **Reset alarm** icon.

Pressing the **Reset alarm** icon mutes the buzzer for all active alarms. The icon then disappears.

- Acknowledging while the alarm condition persists: Only the buzzer turns off. The visual alarm indication remains on the controller display. The alarm remains in the list of active alarms.

When the alarm condition has ended, the visual alarm indication is automatically cleared. The alarm is then no longer in the list of active alarms.

- Acknowledging after the alarm condition has ended: The buzzer and the visual alarm indication are reset together. The alarm is then no longer in the list of active alarms.

## 11.4 Activating / deactivating the audible alarm (alarm buzzer)

Path: [Main menu](#) > [Settings](#) > [Chamber](#)

Chamber		🔒 16:34:28
Chamber name	MKF 056 (E4)	
Language	English	
Language query after restart	Yes	
Temperature unit	Degrees Celsius	
Audible alarm	off	
	<div style="border: 1px solid black; padding: 2px;">                     off                      on                 </div>	

✕
✓

“Chamber” submenu (example).

In the field “Audible alarm” select the desired setting “off” or “on” and press the **Confirm** icon.

## 12. Temperature safety devices

### 12.1 Over temperature protective device (class 1)

The chamber is equipped with an internal temperature safety device, class 1 acc. to DIN 12880:2007. It serves to protect the chamber and prevents dangerous conditions caused by major defects.

If the actual temperature exceeds the nominal temperature by approx. 20 °C, the over temperature protective device permanently turns off the chamber. The user cannot restart the device again. The protective cut-off device is located internally. Only a service specialist can replace it. Therefore, please contact an authorized service provider or BINDER service.

### 12.2 Safety controller (over temperature safety device class 2)

The chambers are regularly equipped with an electronic overtemperature safety controller (temperature safety device class 2 according to DIN 12880:2007). The safety controller is functionally and electrically independent of the temperature control system and serves to protect the chamber, its environment and the contents from exceeding the maximum permissible temperature.



With the option over-/under temperature safety device class 2 (chap. 12.3), the safety controller is **not** used. In this case it must be set to the maximum temperature.

Please observe the DGUV guidelines 213-850 on safe working in laboratories (formerly BGI/GUV-I 850-0, BGR/GUV-R 120 or ZH 1/119, issued by the employers’ liability insurance association) (for Germany).

When the entered safety controller set-point is reached, the overtemperature safety controller turns off the heating, fan, refrigeration system and humidifying system. This condition (state of alarm) is indicated visually and additionally with an audible alert if the buzzer is enabled (chap. 11.4). The alarm persists until the chamber cools down below the configured safety controller setpoint and the alarm is reset manually.



Check the setting regularly and adjust it following changes of the set-point or charge.



The safety controller only activates after the set-point has been reached once.



## 12.2.1 Safety controller modes

You can select between “Limit (absolute)” and “Offset (relative)” safety controller mode

- **Limit:** Absolute maximum permitted temperature value

This setting offers high safety as a defined temperature limit will not be exceeded. It is important to adapt the safety controller set-point after each modification of the temperature set-point. Otherwise, the limit could be too high to ensure efficient protection, or, in the opposite case, it could prevent the controller from reaching an entered set-point outside the limit range.

- **Offset:** Maximum overtemperature above any active temperature set point. The maximum temperature changes internally and automatically with every set-point change.

This setting is recommended for program operation. It is important to check the safety controller set-point and safety controller mode occasionally, as it does not offer a fix, independent limit temperature value, which would never be exceeded.

**Example:** Desired temperature value: 40 °C, desired safety controller value: 45 °C.  
Possible settings for this example:

Temperature set point	Safety controller mode	Safety controller set-point
40 °C	Limit (absolute)	45 °C
	Offset (relative)	5 °C

## 12.2.2 Setting the safety controller



Press the **Setpoint setting** icon to access the “Setpoint” setting menu from Normal display.

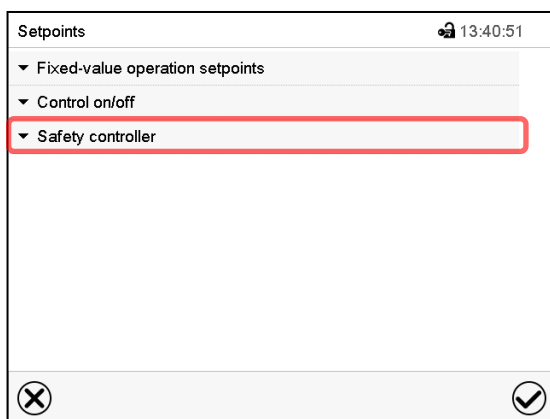

“Setpoints” menu.

Select the field “Safety controller” to access the settings.

- In the field “Mode” select the desired setting “Limit” or “Offset”.

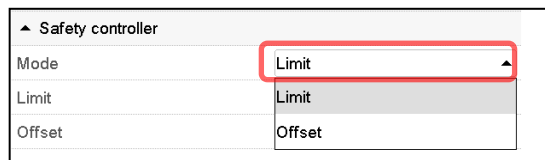

- Select the corresponding field “Limit” **or** “Offset” according to the selected mode and enter the desired safety controller setpoint. Confirm entry with **Confirm** icon.

	<p>Regularly check the safety controller setting for set-point type “Limit” or “Offset”</p> <ul style="list-style-type: none"> <li>• in Fixed value operating mode according to the entered set-point temperature value</li> <li>• in program mode according to the highest temperature value of the selected temperature program</li> </ul> <p>Set the safety controller set-point by approx. 2 °C to 5 °C above the desired temperature set-point.</p>
---	--

After completing the settings, press the **Confirm** icon to take over the entries and exit the menu, **or** press the **Close** icon to exit the menu without taking over the entries.

### 12.2.3 Message and measures in the state of alarm

The state of alarm is indicated visually in Normal display by the alarm message “Safety controller alarm” and the screen header flashing in red color. If the buzzer is enabled (chap. 11.4) there is an additional audible alert (chap. 11.2). The alarm remains active until it is acknowledged on the controller and the inner temperature falls below the set safety controller setpoint. Then the heating is released again.

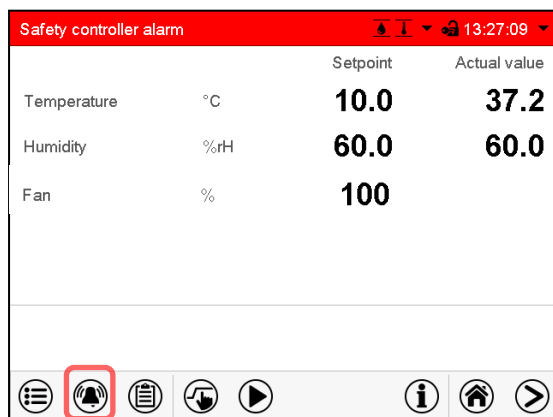

Normal display with safety controller alarm.

Press the **Alarm** icon

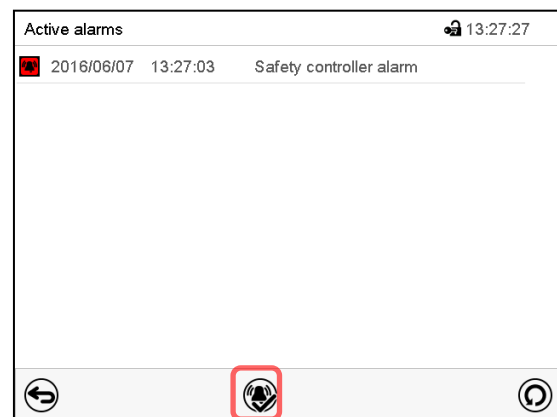

List of active alarms.

Press the **Reset alarm** icon.

### 12.2.4 Function check

Check the safety controller at appropriate intervals for its functionality. It is recommended that the authorized operating personnel should perform such a check, e.g., before starting a longer work procedure.

### 12.3 Over/under temperature safety device class 2 (option)

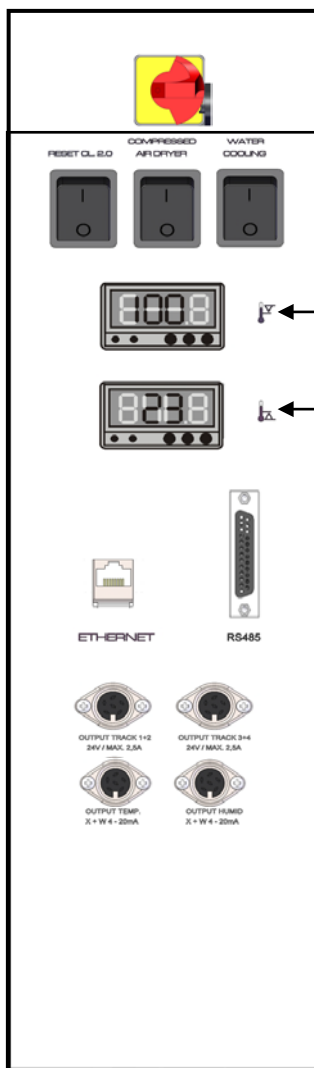

The over-/under temperature safety device (4) consists of two entry modules (4a) and (4b) located in the lateral control panel. Both modules can be set from  $-50\text{ }^{\circ}\text{C}$  /  $-58\text{ }^{\circ}\text{F}$  up to  $200\text{ }^{\circ}\text{C}$  /  $392\text{ }^{\circ}\text{F}$  and serve to define the maximum high and low temperature limits.



With this option, the safety controller (chap. 12.2) must be set to maximum temperature.

(4a) Upper module: Entry of higher limit temperature.

(4b) Lower module: Entry of lower limit temperature.

When the temperature inside the chamber leaves this tolerance bandwidth, the temperature control, and herewith the heating and refrigeration, are turned off permanently.

At the corresponding entry module, the red pilot lamp K1 lights up (K2 is without function).

The controller displays the alarm message "Temp. safety device" (chap. 11.1.2). Additionally there is an audible alert, provided that the buzzer has not been deactivated (chap. 11.4).

Let the chamber heat up or cool down to the defined safety temperature range.

MKF 56: Then press down RESET button (2) "RESET CL 2.0" located in the lateral control panel to re-activate the chamber. The red pilot lamp K1 goes off. Then reset the alarm message on the controller (chap. 11.3).

MKF 115 / 240 / 720: Then reset the alarm message on the controller (chap. 11.3). to re-activate the chamber. The red pilot lamp K1 goes off.

Example: MKF 56

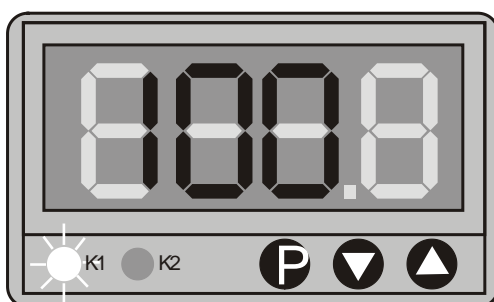

#### Setting limit temperatures at modules (4a) and (4b):

- Press down button P
- The display changes to entry mode
- Enter the desired limit temperature via the arrow keys
- The entered temperature value is adopted after a few seconds. The display shows the actual temperature again.

#### Function check:

Check the over/under temperature safety device class 2 at appropriate intervals for its functionality. It is recommended that the authorized operating personnel should perform such a check, e.g., before starting a longer work procedure.

---

## 13. User management

### 13.1 Authorization levels and password protection

The available functions depend on the current authorization level "Master", "Service", "Admin" or "User".

The authorization levels are hierarchical: Every authorization includes all functions of the next lower level.

#### **"Master" authorization level**

- Highest authorization level, only for developers
- Extensive authorization for controller operation and configuration, outputs/inputs, alarm settings, parameter sets and operating ring display
- All passwords can be changed in the "log out" submenu (chap. 13.3).

#### **"Service" authorization level**

- Authorization level only for BINDER service
- Extensive authorization for controller operation and configuration, access to service data
- The passwords for "Service", "Admin" and "User" authorization levels can be changed in the "log out" submenu (chap. 13.3).

#### **"Admin" authorization level**

- Expert authorization level, for the administrator
- Authorization for controller configuration and network settings and for operating those controller functions required for operating the chamber. Restricted access to service data.
- Password (factory setting): "2".
- The passwords for "Admin" and "User" authorization levels can be changed in the "log out" submenu (chap. 13.3).

#### **"User" authorization level**

- Standard authorization level for the chamber operator
- Authorization for operating the controller functions required for operating the chamber.
- No authorization for controller configuration and network settings. The "Settings" and "Service" sub-menus of the main menu are not available.
- Password (factory setting): "1"
- The password for the "User" authorization level can be changed in the "log out" submenu (chap. 13.3).

As soon as a password has been assigned for an authorization level, the access to this level and the related controller functions are only available after log-in with the appropriate password.

If for an authorization level no password is assigned, the related controller functions of this level are available for every user without login.

If passwords have been assigned for all authorization levels, access to the controller functions is locked without login.

### Operation after user login

At user login, the authorization level is selected and confirmed by entering the respective password.

Following user login, controller operation is available, recognizable by the open-lock icon in the header. The available controller functions correspond to the user's authorization level.

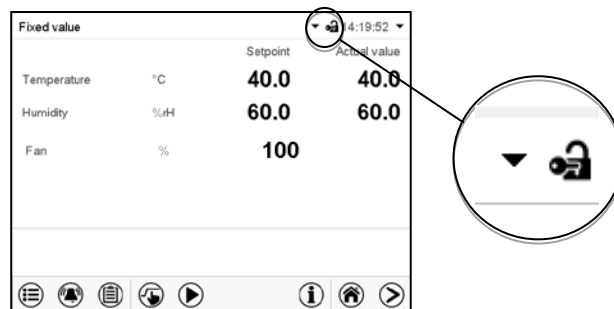

### Password protection activated for all levels: operation without user login is locked

If passwords have been assigned for all authorization levels, the controller is locked without registration of a user.

As long as no user is registered, controller operation is locked, recognizable at the closed-lock icon in the header. This requires that the user management has been activated by the assignment of passwords for the individual authorization levels.

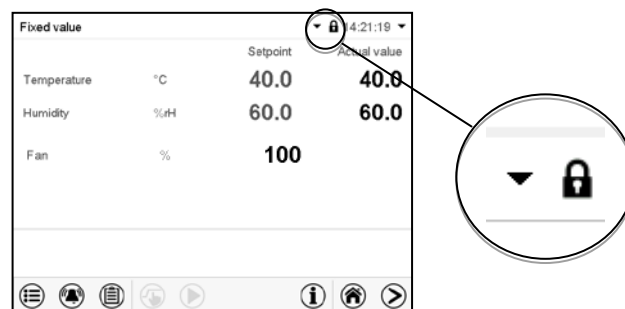

### Password protection for at least one level deactivated: operation without user login is possible

If passwords have not been assigned for all authorization levels, after turning on the chamber there are those controller functions available, which correspond to the highest authorization level without password protection.

No lock icon is shown in the display header.

User login is neither required nor possible.

To activate the password protection and user login, perform new password assignment (chap. 13.5.3).

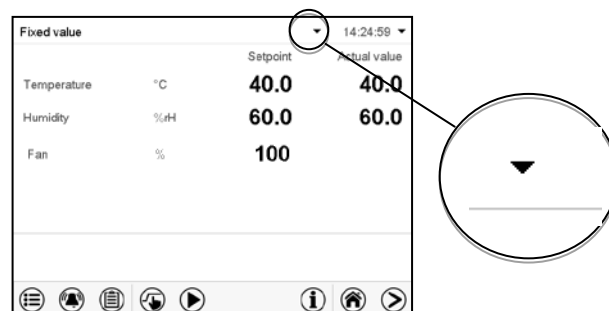

## Information window

To check the authorization level of the user currently logged-in, select in Normal display the arrow far right in the display header.

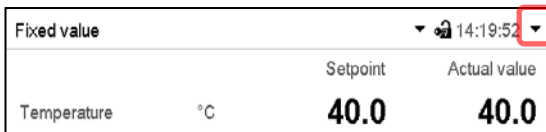

The information window shows date and time, the controller's free memory space and under "Authorization" the authorization level of the current user.

If passwords have been assigned for all authorization levels, a user without login (password entry) has no authorization. There are only viewing functions available.



Display when all authorization levels are password protected and no user has logged in:  
No authorization level is displayed.

If passwords have been assigned only for some of the authorization levels, a user without login (password entry) has access to the functions of the highest authorization level without password protection.



Display when only some of the authorization levels are password protected (example: no protection for the "User" and "Admin" levels) and no user has logged in:  
The user's effective authorization (due to lack of password protection) is shown.  
Example: user with "Admin" authorization.

If passwords have been assigned for some or all of the authorization levels, user login (password entry) provides the authorization for the corresponding password-protected level.



Display when at least some of the authorization levels are password protected and a user has logged in.  
The user's authorization (by password entry) is shown.  
Example: user with "Admin" authorization.

## 13.2 Log in

Path: *Main menu > User > Log in*

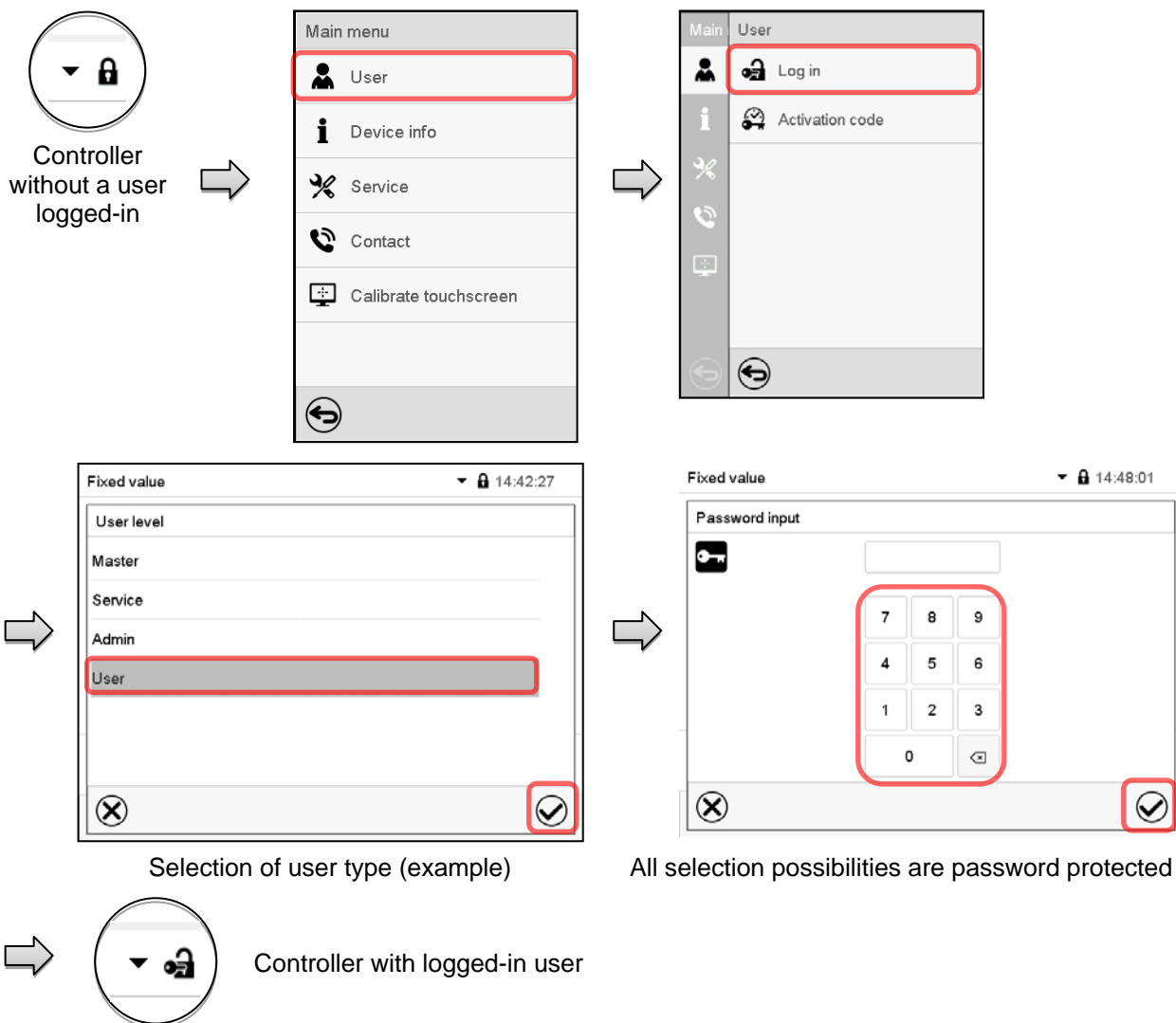

After completing the settings, press the **Confirm** icon to take over the entries and exit the menu, **or** press the **Close** icon to exit the menu without taking over the entries.

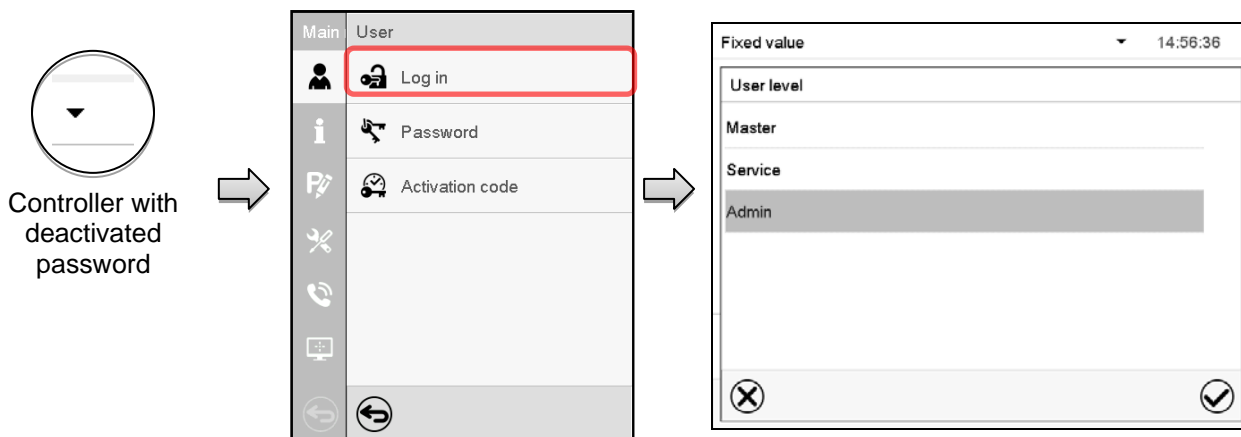

### 13.3 Log out

Path: [Main menu](#) > [User](#) > [Log out](#)

User logoff with “Admin” authorization

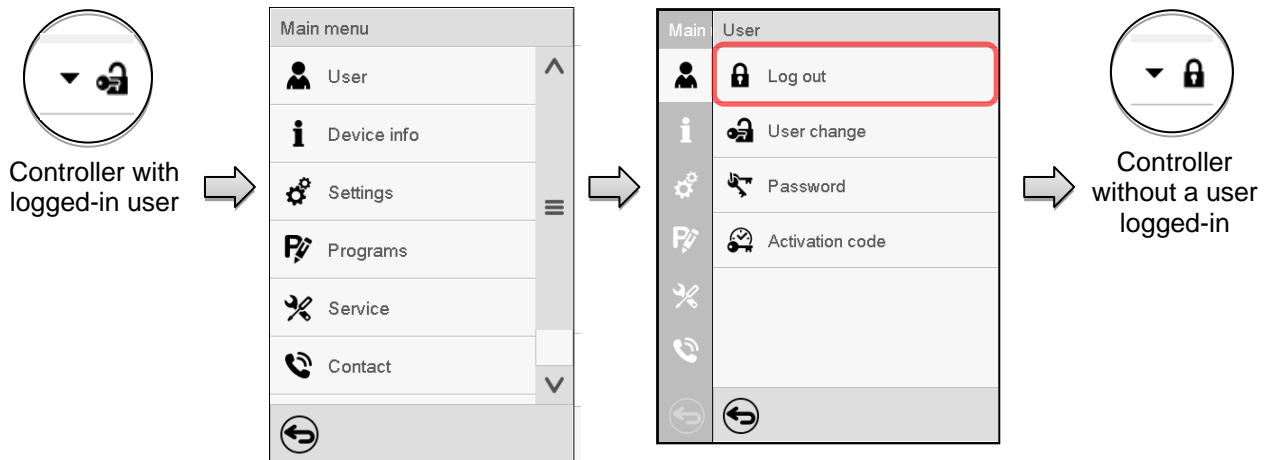

User logoff with “Admin” authorization

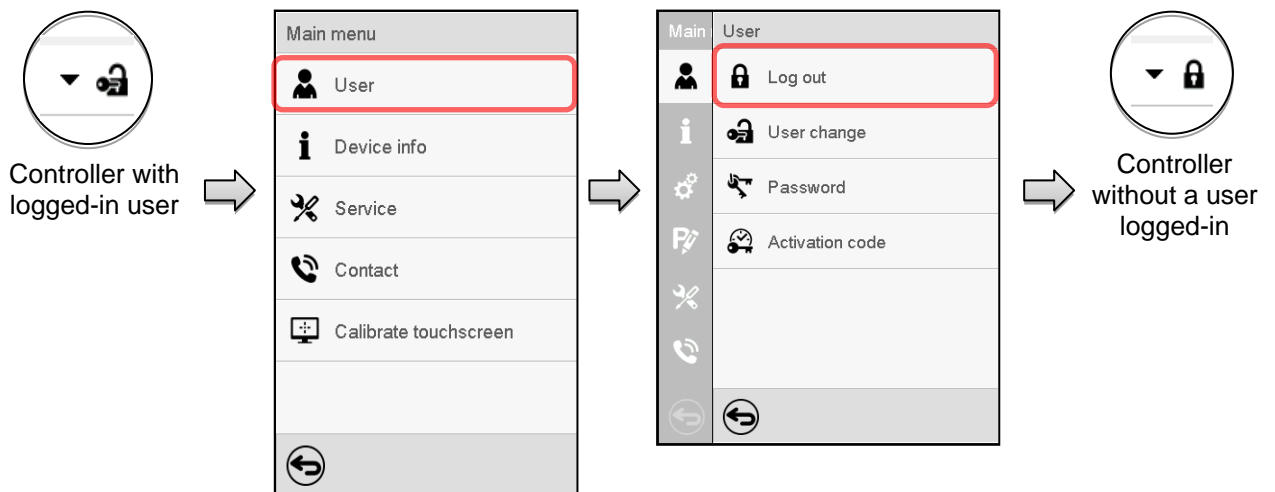

### 13.4 User change

If the password function has been deactivated (chap.13.5.2) this function is not available.

Path: [Main menu](#) > [User](#) > [User change](#)

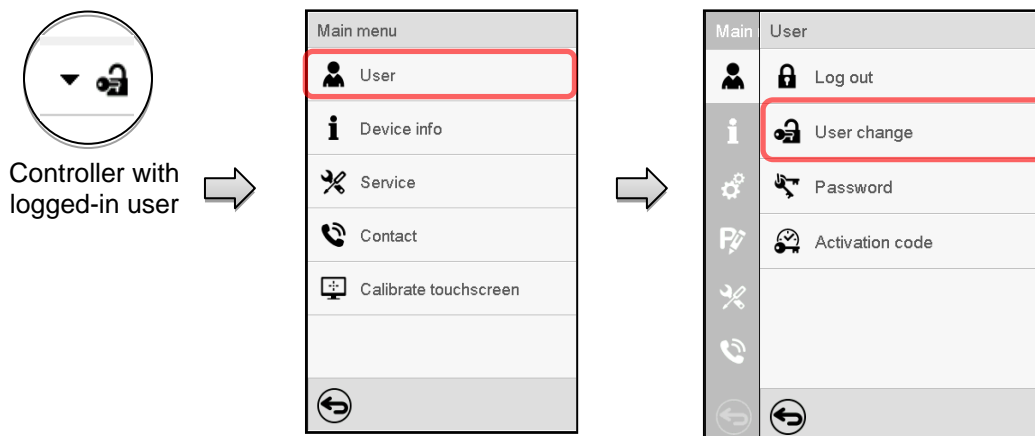



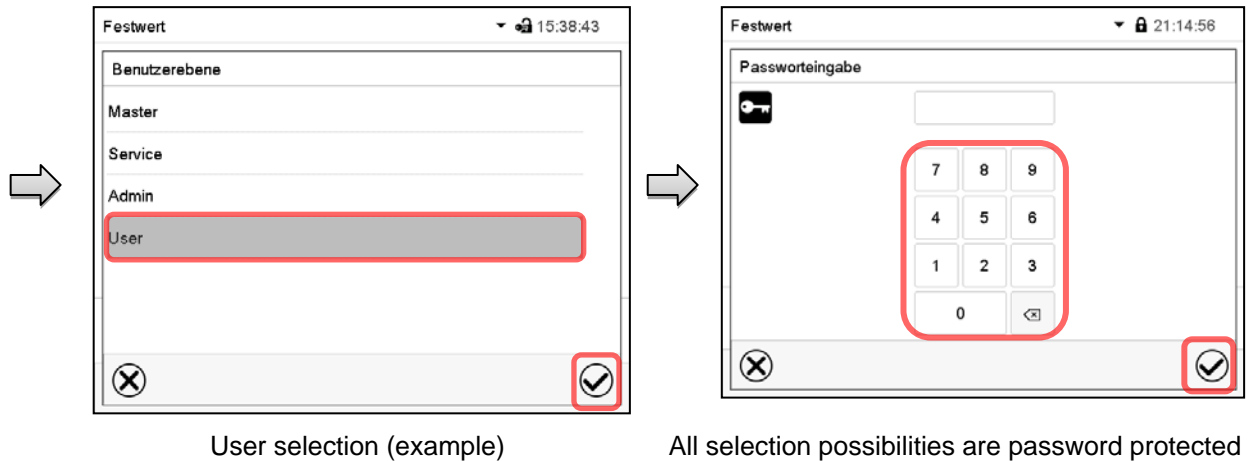

## 13.5 Password assignment and password change

This function is not available for a user logged-in with "User" authorization.

### 13.5.1 Password change

A logged-in user can change the passwords of his current level and of the next lower level(s).

**Example:** A user with "Admin" authorization can change the passwords for the "Admin" and "User" authorization levels.

Path: *Main menu > User > Password*

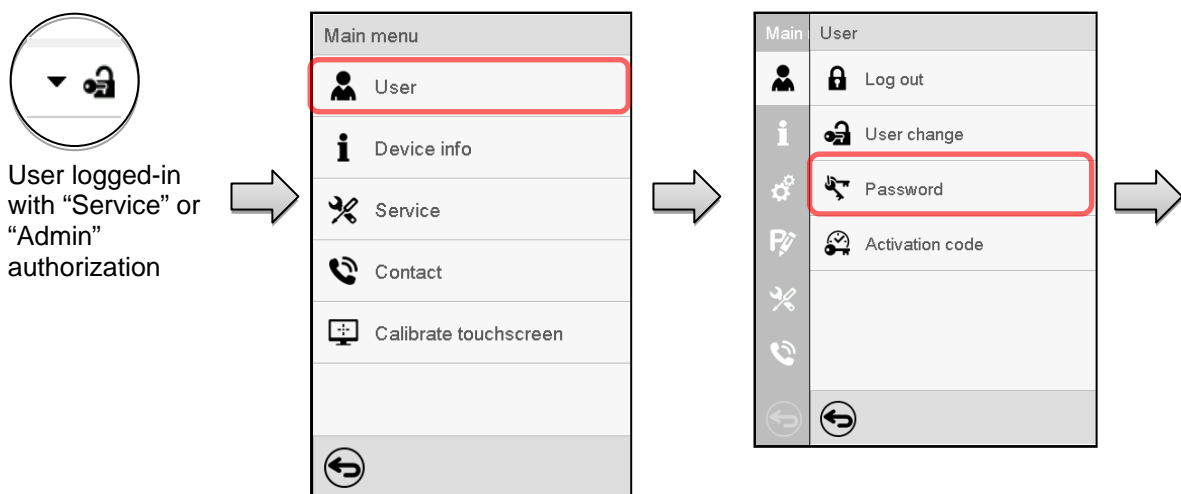



Selection of the authorization level (example: view with "Admin" authorization)

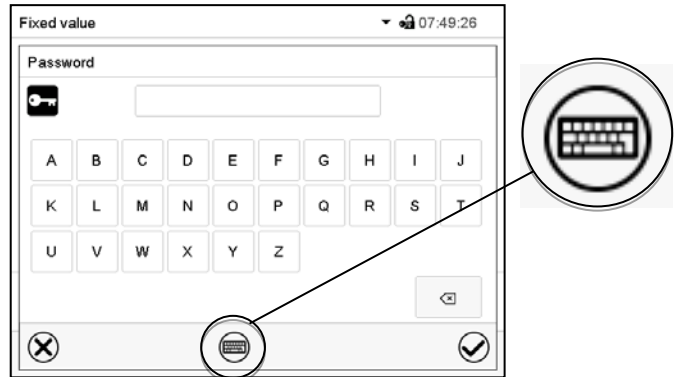

Enter desired password. If desired, press the **Change keyboard** icon to access other entry windows.

In the "Keyboard switch" window you can select different keyboards to enter uppercase and lowercase letters, digits, and special characters. All types of characters can be combined within one single password.

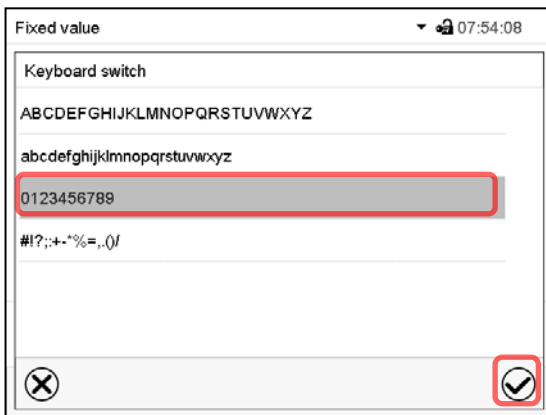

Example: access the digit entry window

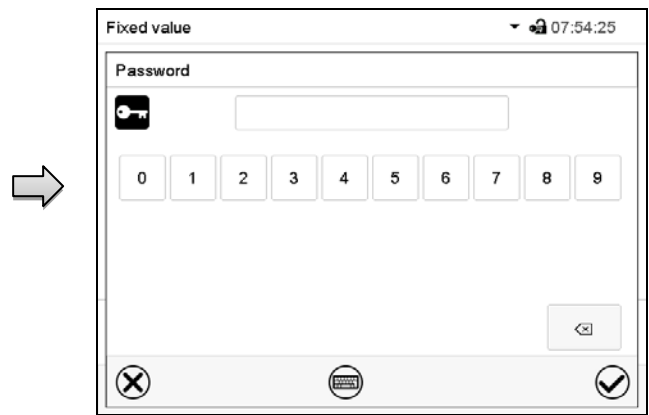

Entry of digits

To confirm the entry, press the **Confirm** icon.

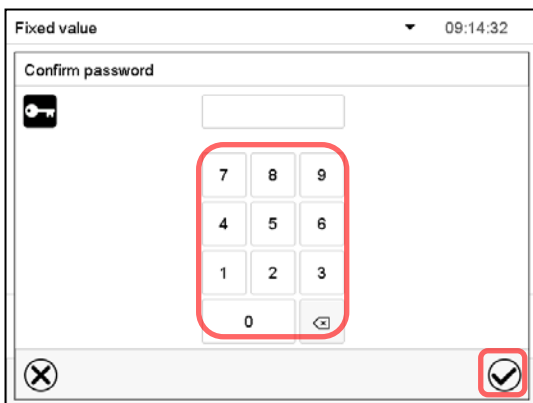

Repeat the password entry for confirmation (sample picture). For each character of the password, the required keyboard appears automatically. Then press the **Confirm** icon.

### 13.5.2 Deleting the password for an individual authorization level

A user logged-in with “Service” or “Admin” authorization can delete the passwords of his current level and of the next lower level(s). To do this no password is entered during a password change.

Path: *Main menu > User > Password*



Controller with logged-in user (e.g. with “Admin” authorization)

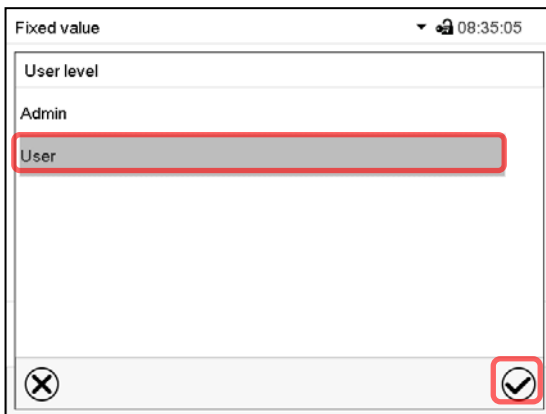
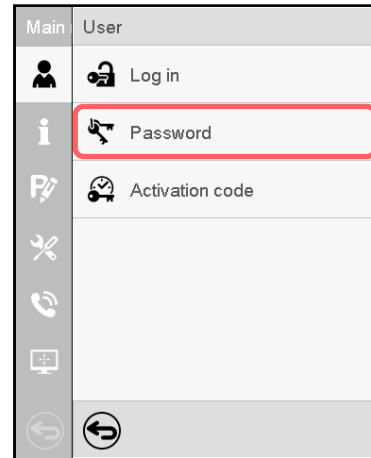
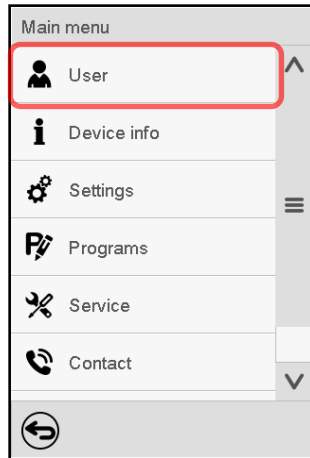

Select the authorization level for which the password shall be deleted.

Do NOT enter anything in the “Password” screen. Press the **Confirm** icon.

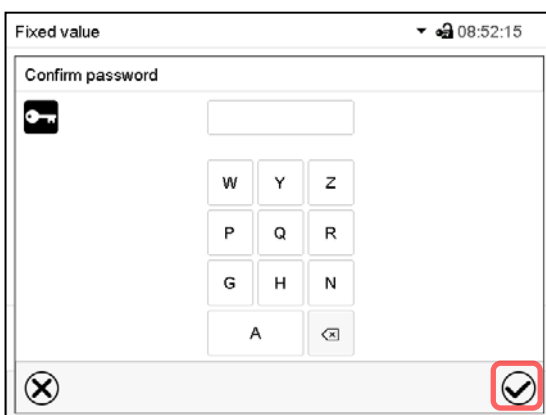

The password is deleted.

Do NOT enter anything in the “Confirm password” screen. Press the **Confirm** icon.

### 13.5.3 New password assignment for “service” or “admin” authorization level when the password function was deactivated

If the password protection for an authorization level has been deactivated, i.e., no password is assigned, no login for this level is possible. Therefore access to this authorization level is available without login.

If the password for the “Service” or “Admin” authorization has been deleted (chap. 13.5.2), a new password can be assigned for the current level and the next lower level(s) without user login.

**Example:** The password for the “Admin” authorization level was deleted, therefore every user without login has full access to the functions of the “Admin” authorization level. If access to this level shall become password protected again, the user can assign a new password for the “Admin” authorization level with the “Password” function.

Path: [Main menu](#) > [User](#) > [Password](#)

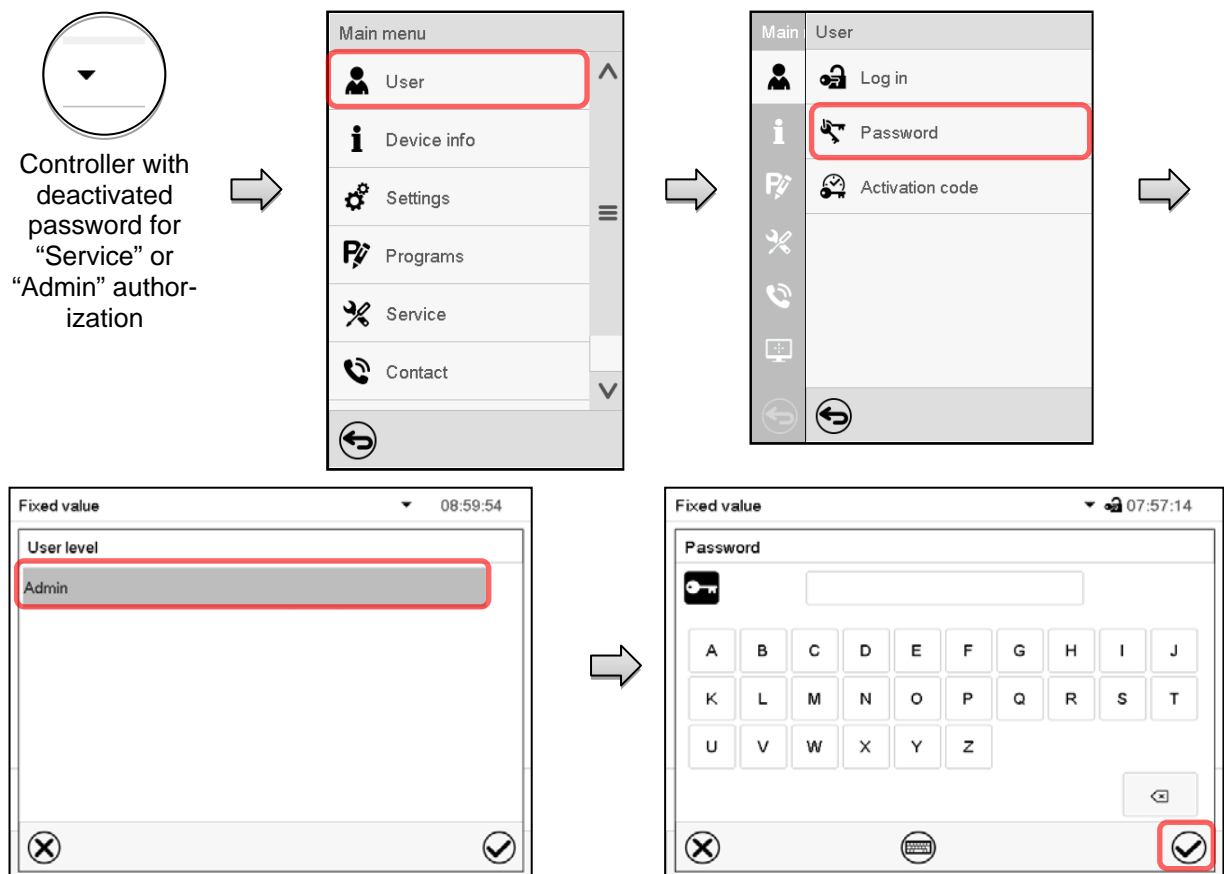

Select the authorization level, for which you want to assign a password.  
(Example: “Admin” authorization)

Enter the desired password. If desired, press the **Change keyboard** icon to access other entry windows.

To confirm the entry, press the **Confirm** icon.

Repeat the password entry for confirmation. For each character of the password, the required keyboard appears automatically. Then press the **Confirm** icon.

### 13.6 Activation code

Certain functions of the controller can be unlocked with a previously generated activation code.

The activation code enables access to functions available only in the "Service" authorization level by users without a "Service" authorization. Such functions include e.g., adjustment or extended configurations.

The activation code is available in authorization levels.

Path: [Main menu](#) > [User](#) > [Activation code](#)

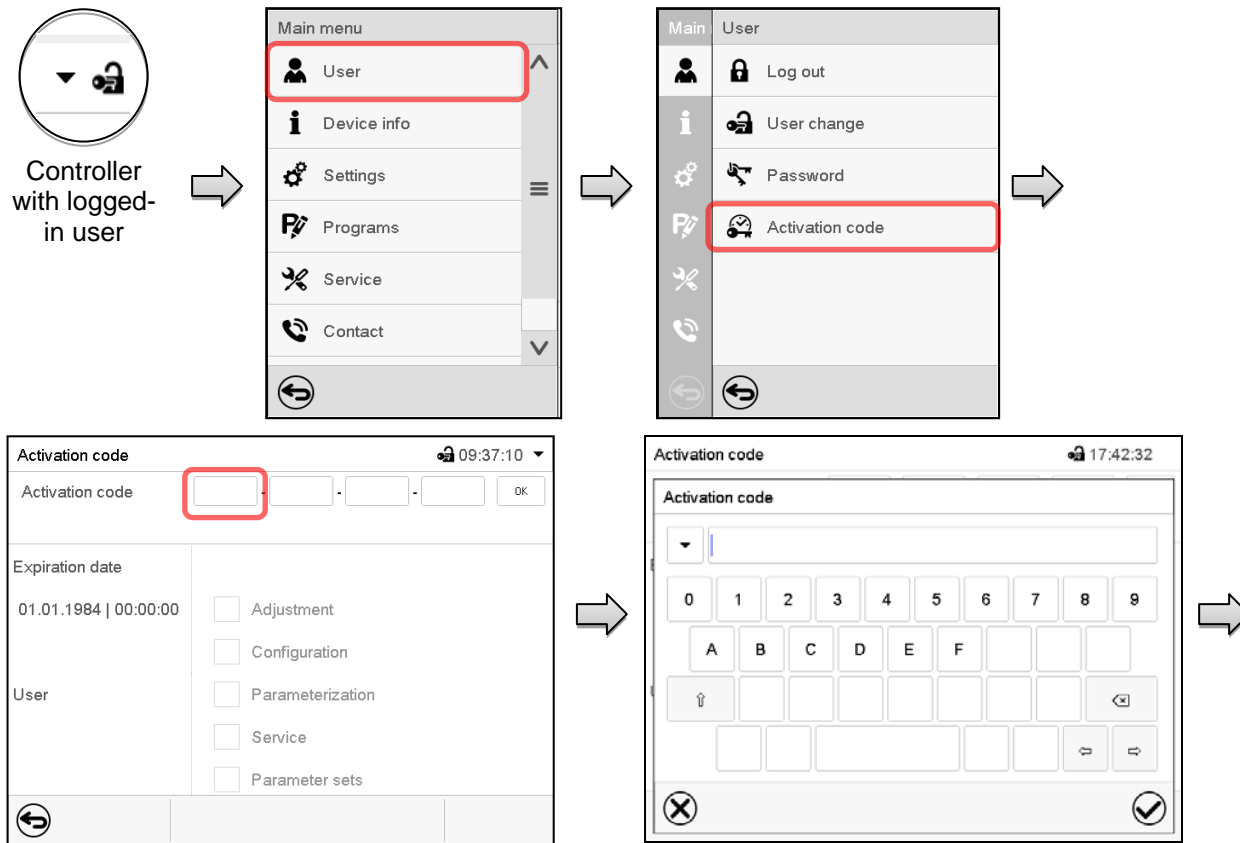

Activation code menu.  
Select the first of the four entry fields.

Activation code entry window.  
Enter the first four characters of the activation code and press the **Confirm** icon.

Select the next of the four entry fields and proceed accordingly until the entire code has been entered.

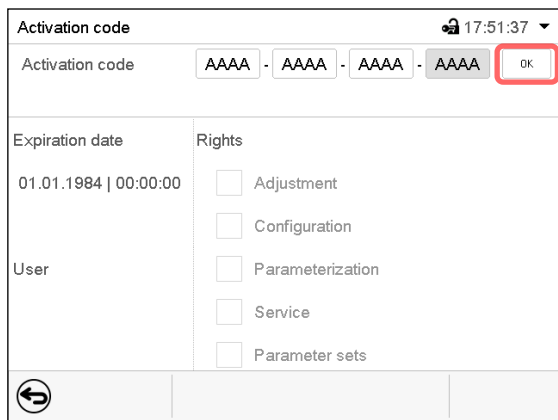

"Activation code" menu with entered code (sample view).  
Press **OK** to take over the entry

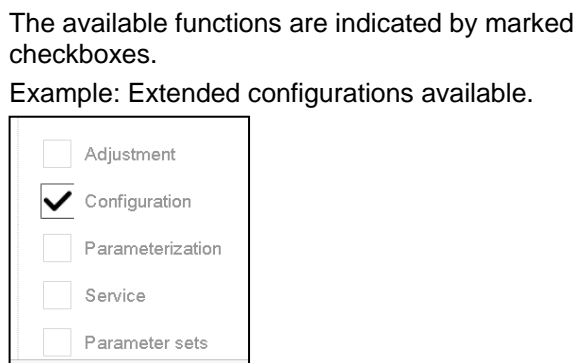

The available functions are indicated by marked checkboxes.  
Example: Extended configurations available.

## 14. General controller settings

Most of the general settings can be accessed in the “Settings” submenu, which is available for users with “Service” or “Admin” authorization level. It serves to enter date and time, select the language for the controller menus and the desired temperature unit and to configure the controller’s communication functions.

### 14.1 Selecting the controller’s menu language

The MB2 program controller communicates by a menu guide using real words in German, English, French, Spanish, and Italian.

Path: [Main menu](#) > [Settings](#) > [Chamber](#)

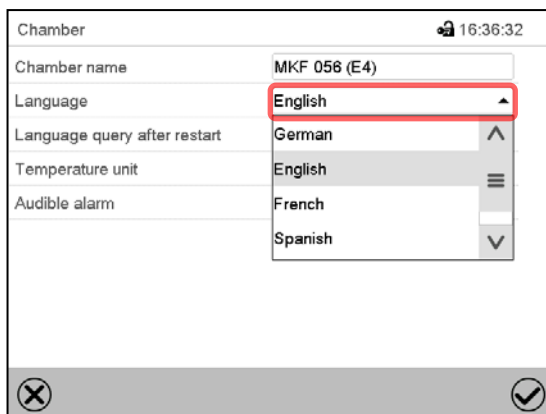

The screenshot shows the 'Chamber' submenu with the following settings: Chamber name: MKF 056 (E4); Language: English (selected); Language query after restart: German; Temperature unit: English; Audible alarm: French. The 'Language' dropdown menu is open, showing options: English, German, Spanish.

“Chamber” submenu.

Select the desired language.

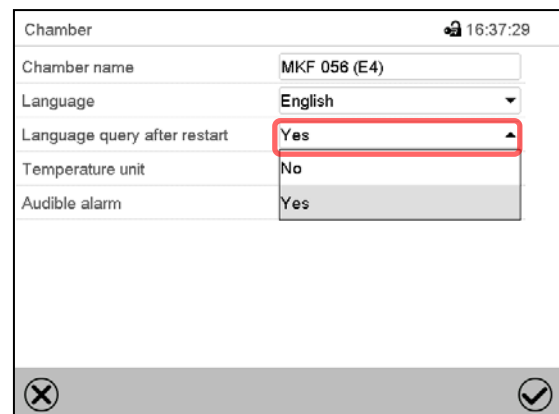

The screenshot shows the 'Chamber' submenu with the following settings: Chamber name: MKF 056 (E4); Language: English; Language query after restart: Yes (selected); Temperature unit: No; Audible alarm: Yes. The 'Language query after restart' dropdown menu is open, showing options: Yes, No.

“Chamber” submenu.

Select if there shall be a language query after restarting the chamber and press the **Confirm** icon.

Return to Normal display with the **Back** icon to take over the entries.

### 14.2 Setting date and time

Following start-up of the chamber after language selection:

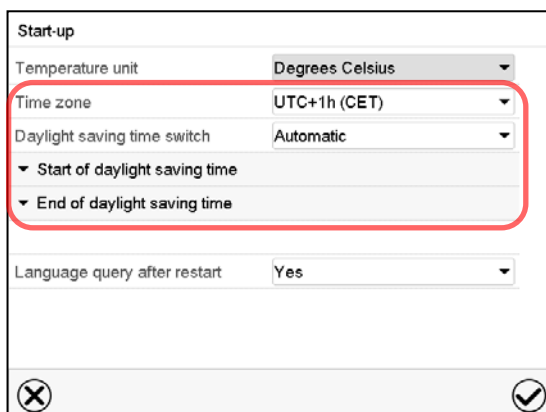

The screenshot shows the 'Start-up' submenu with the following settings: Temperature unit: Degrees Celsius; Time zone: UTC+1h (CET); Daylight saving time switch: Automatic; Start of daylight saving time: (dropdown); End of daylight saving time: (dropdown); Language query after restart: Yes. The 'Time zone' and 'Daylight saving time switch' settings are highlighted with a red box.

Select the time zone and configure the daylight saving time switch.

Or later:

Path: [Main menu](#) > [Settings](#) > [Date and time](#)

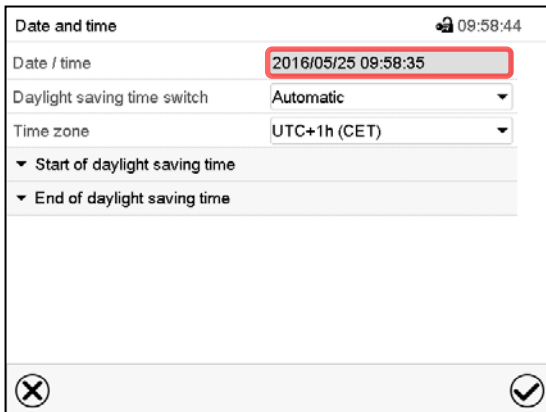

“Date and time” submenu.  
Select the field “Date / time”.

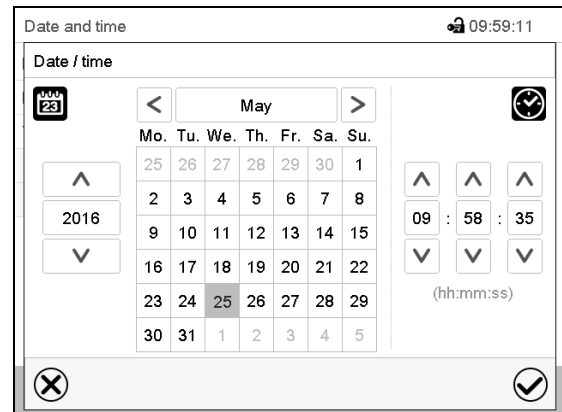

“Date / time” entry menu.  
Enter date and time and press the **Confirm** icon.

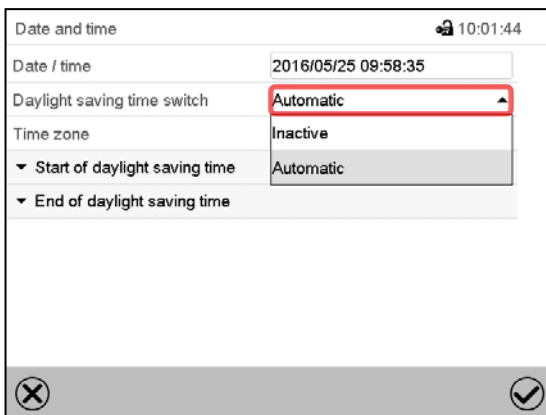

“Date and time” submenu.  
In the field “Daylight saving time switch” select the desired setting “Automatic” or “Inactive”.

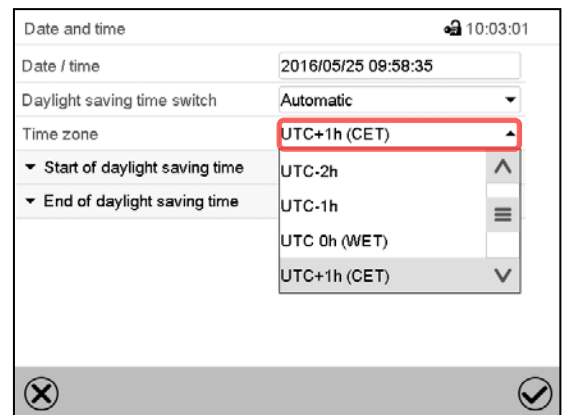

“Date and time” submenu.  
Select the desired time zone and press the **Confirm** icon.

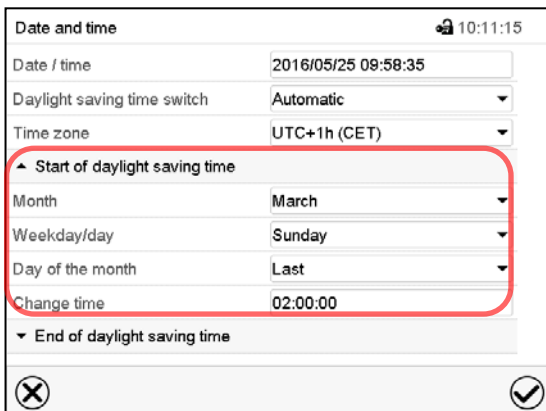

“Date and time” submenu.  
Select the desired start of the daylight saving time.

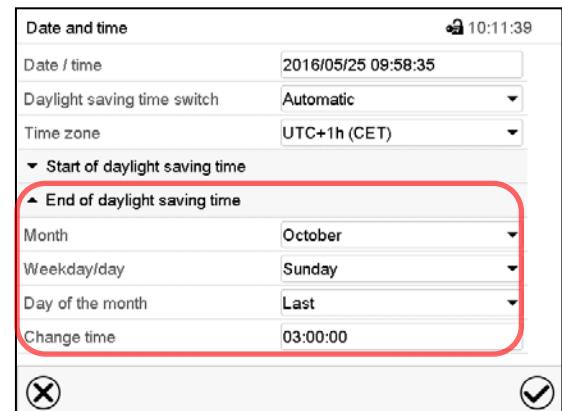

“Date and time” submenu.  
Select the desired end of the daylight saving time and press the **Confirm** icon.

After completing the settings, press the **Confirm** icon to take over the entries and exit the menu, **or** press the **Close** icon to exit the menu without taking over the entries.

## 14.3 Selecting the temperature unit

Following start-up of the chamber:

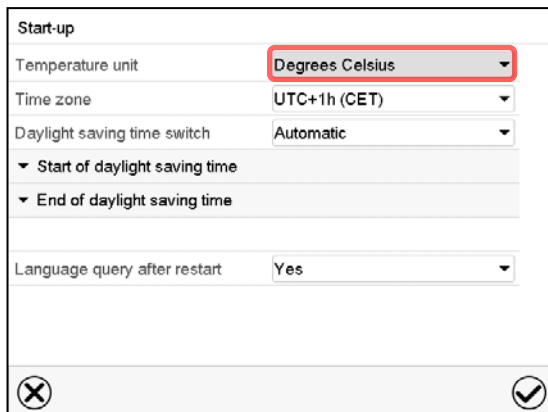

Start-up

Temperature unit: Degrees Celsius

Time zone: UTC+1h (CET)

Daylight saving time switch: Automatic

Start of daylight saving time

End of daylight saving time

Language query after restart: Yes

Or later:

Path: [Main menu](#) > [Settings](#) > [Chamber](#)

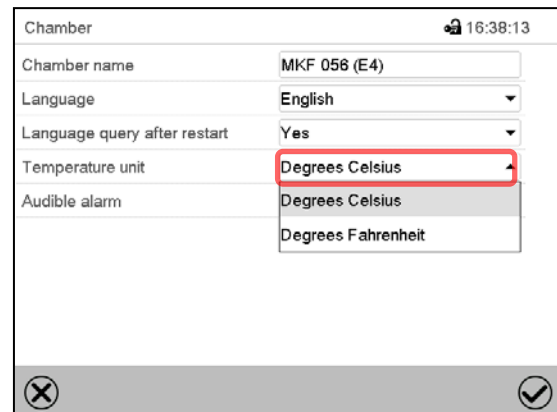

Chamber 16:38:13

Chamber name: MKF 056 (E4)

Language: English

Language query after restart: Yes

Temperature unit: Degrees Celsius

Audible alarm: Degrees Celsius

Degrees Fahrenheit

Select the desired temperature unit and press the **Confirm** icon.

Change of the temperature unit between °C and °F.

If the unit is changed, all values are converted accordingly

	C = degree Celsius	0 °C = 32 °F	Conversion: [value in °F] = [value in °C] * 1,8 + 32
	F = degree Fahrenheit	100 °C = 212 °F	

## 14.4 Display configuration

### 14.4.1 Adapting the display parameters

This function serves to configure parameters like display brightness and operating times.

Path: [Main menu](#) > [Settings](#) > [Display](#) > [Display](#)

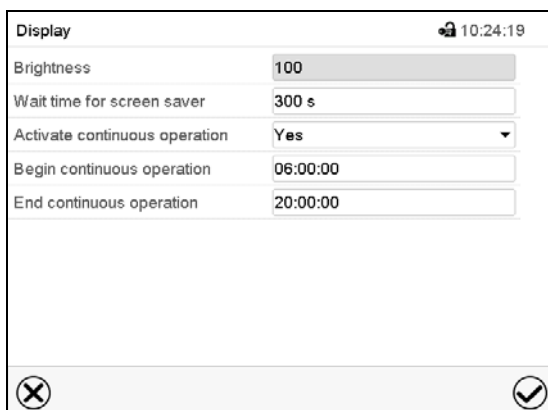

Display 10:24:19

Brightness: 100

Wait time for screen saver: 300 s

Activate continuous operation: Yes

Begin continuous operation: 06:00:00

End continuous operation: 20:00:00

“Display” submenu.



- Select the field “Brightness”.  
Move the grey slide to the left or right to define the brightness of the display
  - left = darker (minimum value: 0)
  - right = brighter (maximum value: 100)
 Press the **Confirm** icon.

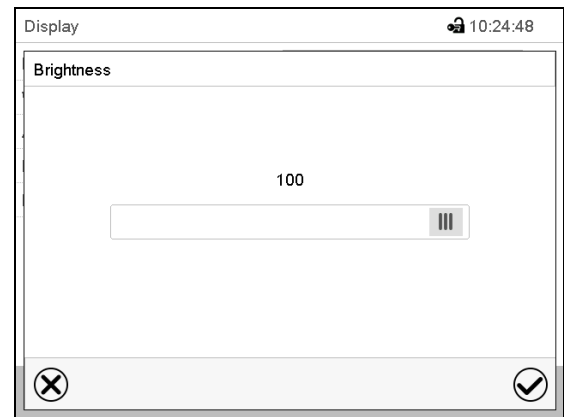

- Select the field “Wait time for screen saver” and enter the desired waiting time for the screen saver in seconds. Setting range: 10 sec up to 32767 sec. During the waiting time the display is off. Confirm entry with **Confirm** icon.
- In the field “Activate continuous operation” select the desired setting “Yes” or “No”.

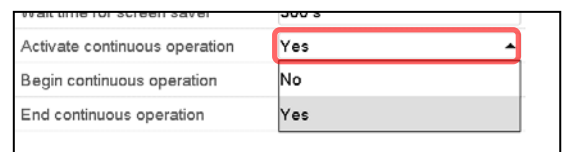

- Select the field “Begin continuous operation” (possible only if continuous operation is activated) and enter the time with the arrow keys. Confirm entry with **Confirm** icon.
- Select the field “End continuous operation. (only possible if continuous operation is activated) and enter the time with the arrow keys. Confirm entry with **Confirm** icon.

After completing the settings, press the **Confirm** icon to take over the entries and exit the menu, **or** press the **Close** icon to exit the menu without taking over the entries.

## 14.4.2 Touchscreen calibration

Path: [Main menu](#) > [Calibrate touchscreen](#)

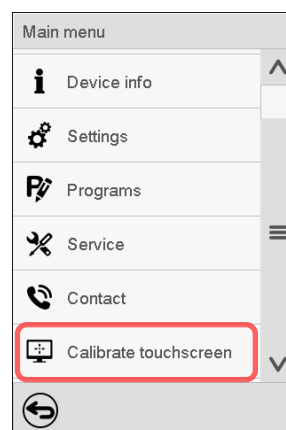
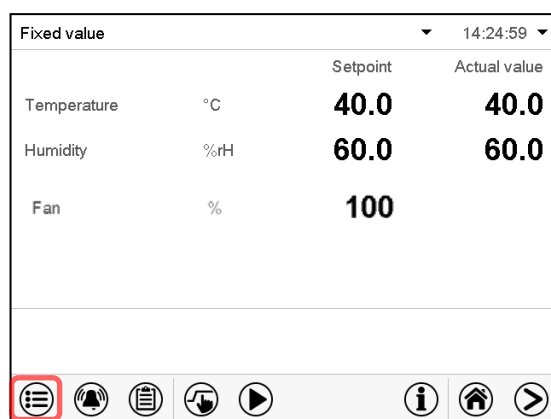

Normal display.

Select “Calibrate touchscreen” and follow the instructions on the display.

You need to touch all four corners of the touchscreen to calibrate it. Appropriate boxes appear successively in each corner.



The waiting icon shows how much time there is left to touch the currently activated box. If the box is not touched within this period, calibration is aborted and the display changes to Normal display.

After completing the calibration, i.e., touching all four boxes, the display changes to Normal display.

## 14.5 Network and communication

For these settings at least the “Admin” authorization level is required.

### 14.5.1 Serial interfaces

The chamber is optionally equipped with a serial RS485 interface.

This menu allows to configure the communication parameters of the RS485 interface.

The device address is required to recognize chambers with this interface type in a network, e.g. when connecting it to the optional communication software BINDER APT-COM™ 3 DataControlSystem (chap. 21.1). In this case do not change the other parameters.

Path: [Main menu](#) > [Settings](#) > [Serial interfaces](#)

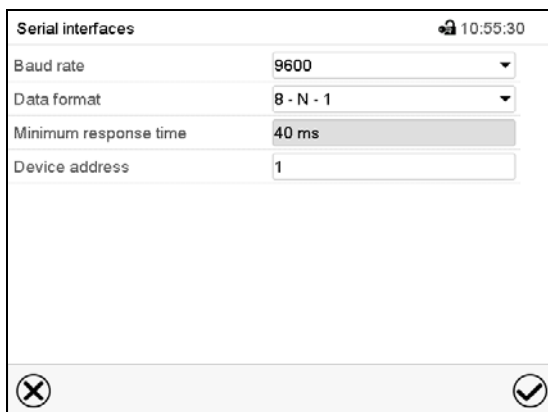

“Serial interfaces” submenu.

- Select the desired setting in the field “Baud rate”.

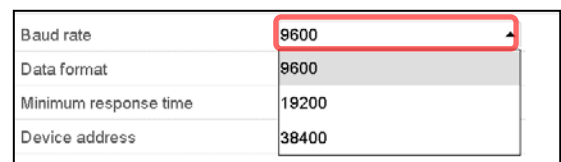

- Select the desired setting in the field “Data format”.

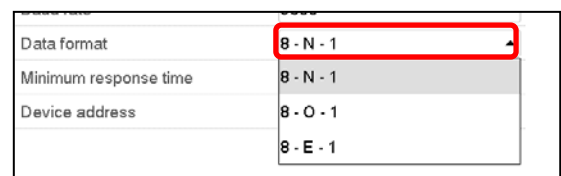

- Select the field “Minimum response time” and enter the desired minimum response time. Confirm entry with **Confirm** icon.
- Select the field “Device address” and enter the device address. Factory setting is “1”. Confirm entry with **Confirm** icon.

After completing the settings, press the **Confirm** icon to take over the entries and exit the menu, **or** press the **Close** icon to exit the menu without taking over the entries.

## 14.5.2 Ethernet

### 14.5.2.1 Configuration

Path: [Main menu](#) > [Settings](#) > [Ethernet](#)

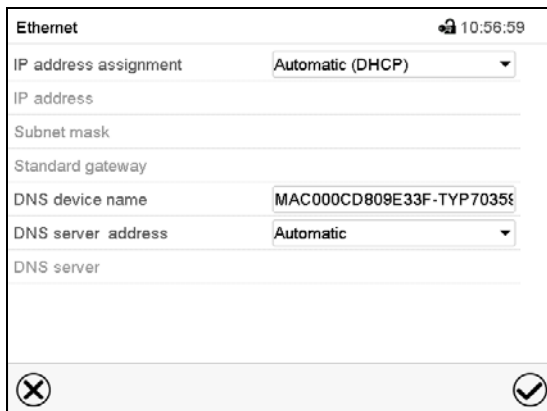

“Ethernet” submenu.

- In the field “IP address assignment” select the desired setting “Automatic (DHCP)” or “Manual”.

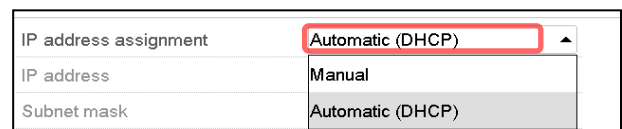

With selection “Manual” you can enter the IP-address, the subnet mask and the standard gateway manually.

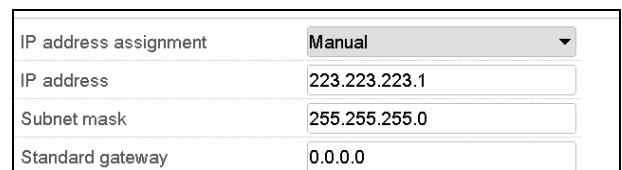

- Select “DNS device name” and enter the DNS device name. Confirm entry with **Confirm** icon.
- In the field “DNS server address” select the desired setting “Automatic” or “Manual”.

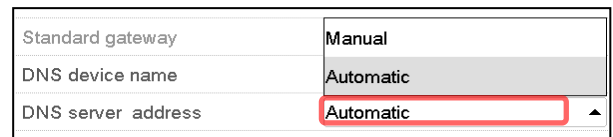

With selection „Manual“ you can enter the DNS server address manually.

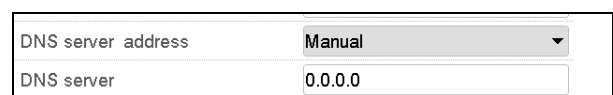

After completing the settings, press the **Confirm** icon to take over the entries and exit the menu, **or** press the **Close** icon to exit the menu without taking over the entries.

### 14.5.2.2 Display of MAC address

Path: [Main menu](#) > [Device info](#) > [Ethernet](#)

Ethernet		🔒 13:49:56
Ethernet	Yes	^
MAC address	00-0C-D8-09-E3-3F	
IP address	192.168.14.87	
Subnet mask	255.255.255.0	
Standard gateway	192.168.14.1	☰
DNS server	192.168.10.5	
DNS device name	MAC000CD809E33F-TYP703596	
		v

“Ethernet” submenu (example).

### 14.5.3 Web server

This controller menu serves to configure the web server. Then you can enter the chamber’s IP-address in the Internet. The IP address is available via [Chamber information](#) > [Ethernet](#). The BINDER web server opens. Enter the user name and password which have been assigned for the web server in the controller menu. This enables online access to the controller display, to see e.g., the event list or error messages. In this view no settings can be changed.

Path: [Main menu](#) > [Settings](#) > [Web server](#)

Web server		🔒 11:08:32
Password active	Yes	▼
User name	admin	
Password	1234	
Automatic log out after	0 Min	

“Webserver” submenu.

- In the field “Password active” select the desired setting “Yes” or “No”.

Password active	Yes
User name	No
Password	Yes

- Select the field “User name” and enter the desired user name. Confirm entry with **Confirm** icon.
- Select the field “Password” and enter the desired password. Confirm entry with the **Confirm** icon.
- Select the field “Automatic log out after” and enter the time in minutes after which the webserver shall log out automatically. Setting range: 0 min to 65535 min. Confirm entry with **Confirm** icon.

After completing the settings, press the **Confirm** icon to take over the entries and exit the menu, **or** press the **Close** icon to exit the menu without taking over the entries.

## 14.5.4 E-Mail

As soon as an alarm was triggered, an e-mail is sent to the configured e-mail address.

Path: [Main menu](#) > [Settings](#) > [Email](#)

### E-mail address entry:

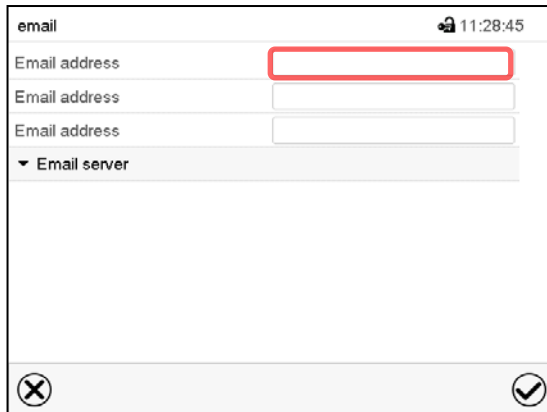

“Email” submenu.

Select the desired e-mail address field and enter the e-mail address. You can use the **Keyboard change** icon for entry. Confirm entry with **Confirm** icon.

### E-mail server settings:

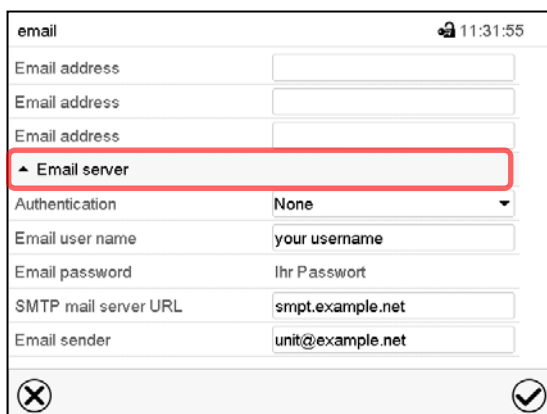

“Email” submenu.

Select the field “Email server” to access the settings

- In the field “Authentication” select the desired setting “None” or “SMTP” auth“.

With the setting “SMTP auth”, you can enter a password under “Email password”.

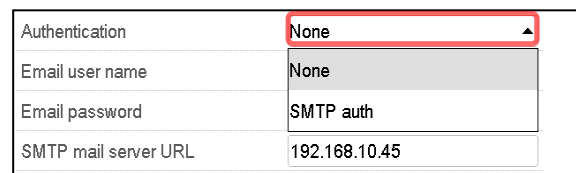

- Select the field “Email user name” and enter the desired user name. Confirm entry with **Confirm** icon.
- Select the field “SMTP mail server URL” and enter the SMPT mail server URL. Confirm entry with **Confirm** icon.
- Select the field “Email sender” and enter the desired Email sender. Confirm entry with **Confirm** icon.

After completing the settings, press the **Confirm** icon to take over the entries and exit the menu, **or** press the **Close** icon to exit the menu without taking over the entries.

## 14.6 USB menu: Data transfer via USB interface

The USB port is located in the instrument box.

When you insert a USB-stick, the “USB” menu opens.

Depending on the user’s authorization level, different functions (highlighted in black) are available for the logged-in user.

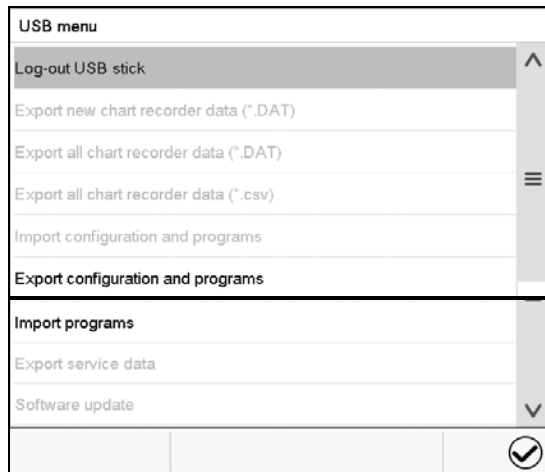

Available functions  
with “User” authorization level

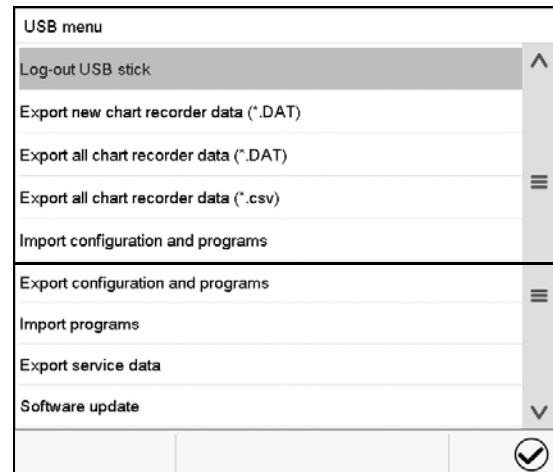

Available functions  
with “Admin” authorization level

Function	Explanation
Log-out USB stick	Log-out USB stick bevor pulling it
Export new chart recorder data (*.DAT)	Export chart recorder data, which have been added since last export, in .dat format
Export all chart recorder data (*.DAT)	Export all chart recorder data in .dat format
Export all chart recorder data (*.csv)	Export all chart recorder data in .csv format
Import configuration and programs	Import configuration and timer / time / week programs
Export configuration and programs	Export configuration and timer / time / week programs
Import programs	Import timer / time / week programs
Export service data	Export service data (including self-test data, chap. 15.5)
Software update	Controller firmware update

## 14.7 Turning off the interior lighting automatically



Press the **Interior lighting** icon to turn on and off the interior lighting.

Additionally, you can define in this menu the interval after which the turned-on light will turn off automatically.

Path: **Main menu > Settings > Various**

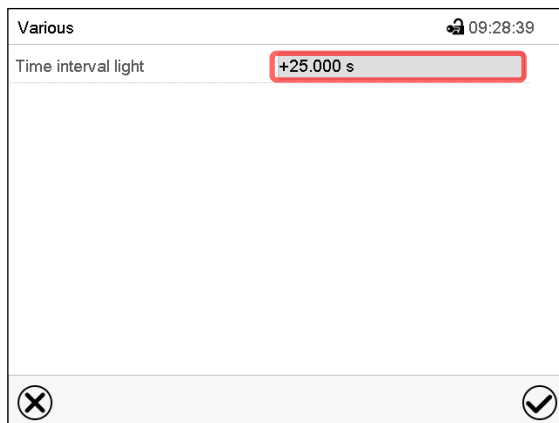

“Various” submenu

Select the field “Time interval light”.

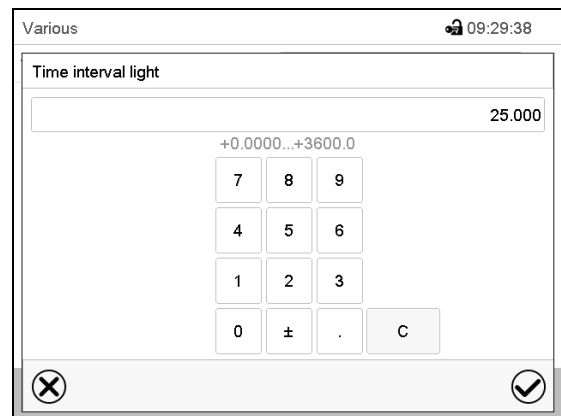

“Time interval light” entry menu

Enter the time in seconds after which the light shall turn off automatically.

Setting range: 0 sec up to 3600 sec

After completing the settings, press the **Confirm** icon to take over the entries and exit the menu, **or** press the **Close** icon to exit the menu without taking over the entries.

## 15. General information

### 15.1 Service contact page

Path: **Main menu > Contact**

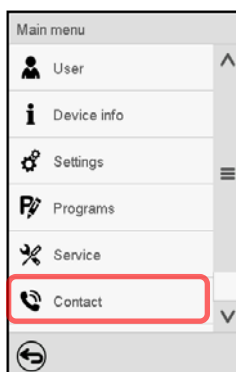

## 15.2 Current operating parameters

 Press the **Information** icon to access the “Info” menu from Normal display.

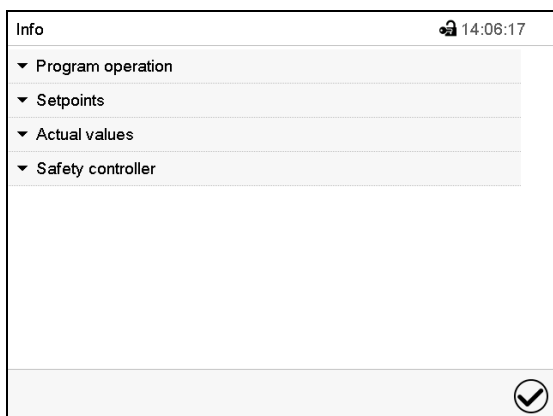

“Info” menu.  
Select the desired information.

- Select “Program operation” to see information on a currently running program.

▲ Program operation	
Program type	Time program
Program name	program 1
	Programmhinweis
Program info	
Program start	08.06.2016 07:34:57
Program duration	87:00:00
Rem. program runtime	87:00:00
Program end	11.06.2016 22:35:49
Section number	1 / 87
Section duration	00:00:00
Remaining section time	01:00:00

- Select “Setpoints” to see information on the entered setpoints and operation lines.

▲ Setpoints	
Temperature	40.0 °C
Humidity	80.0 %rH
Fan	100.0 %
Operation lines	0000000000000000

- Select “Actual values” to see information on the current actual values.

▲ Actual values	
Temperature	40.0 °C
Humidity	80.0 %

- Select “Safety controller” to see information on the safety controller status.

▲ Safety controller	
Switch value	40.0 °C
Actual value	20.3 °C
Status	Not triggered



### 15.3 Event list

The "Event list" displays status information and errors of the current day. It enables to view the last 100 events or defective conditions of the chamber.

 Press the **Event list** icon to access the event list from Normal display.

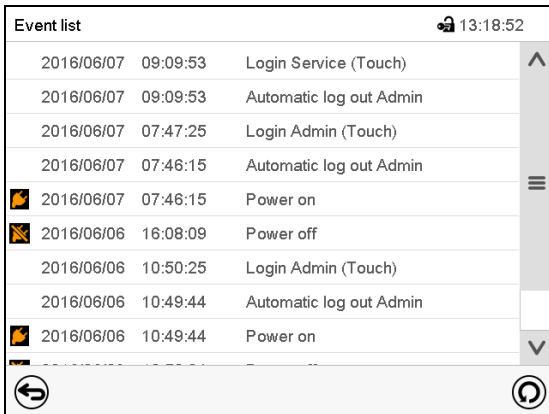

Event list

 Press the **Update** icon to update the event list.

 **Attention:** Following a modification of the language setting (chap. 14.1) or the storage interval of the chart recorder (chap. 16.2) the Event list is cleared.

### 15.4 Technical chamber information

Path: [Main menu > Device info](#)

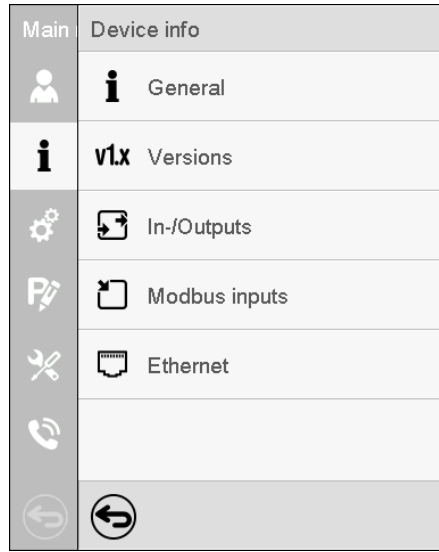
	Device info	
	General	
	v1.x Versions	
	In-/Outputs	
	Modbus inputs	
	Ethernet	
	Back to main menu	

Chamber name and setup	
Versions of CPU, I/O module and safety controller	for BINDER Service
Information on digital and analog inputs and outputs and phase angle outputs	for BINDER Service
Information on modbus analog and digital inputs	for BINDER Service
Information on Ethernet connection, MAC address display	chap. 14.5.2
Back to main menu	

## 15.5 Self-test function

The self-test function enables an automated check of the proper chamber functioning as well as a targeted and reliable fault analysis. It is available with the "Master", "Service", and "Admin" authorization levels.

In this case, the chamber successively undergoes various defined operating states, which serves to determine reproducible characteristic values. These characteristic values provide information on the performance and precision of the individual functional systems of the chamber (e.g., heating, refrigeration, humidification) of the chamber.

The results of the self-test are stored in the service recorder of the controller. You can export them using the controller's USB interface and send them to BINDER Service (use function "Export service data" to USB stick, chap. 14.6). BINDER Service will evaluate the data using an analyzing tool.

### Activating the self-test mode



In order to allow an optimum comparison of the determined characteristic values with the reference characteristic values, the ambient temperature should be in the range of  $+22\text{ °C}$   $\pm 3\text{ °C}$  /  $71.6\text{ °F}$   $\pm 5.4\text{ °F}$ .

The chamber shall be unloaded (empty with standard equipment).

Path: [Main menu](#) > [Settings](#) > [Various](#)

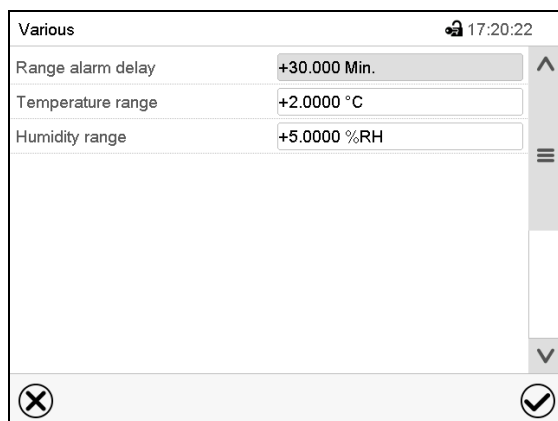

Submenu "Various".

Scroll all the way down to access the "Self-test" function.



Submenu "Various".

Select the field "Self-test".

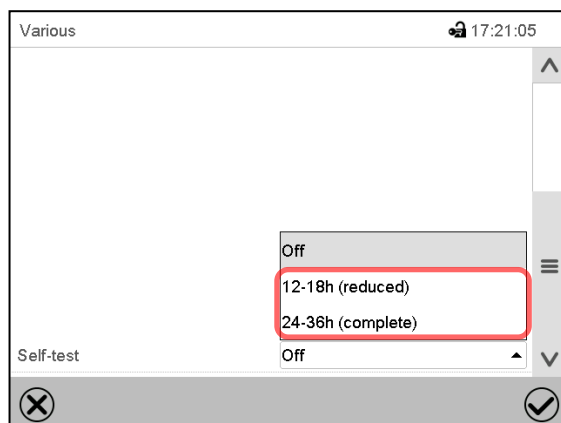

Submenu "Various".

To start the self-test, select the desired test duration. Confirm entry with **Confirm** icon.

Return to Normal display with the **Back** icon to take over the entries.

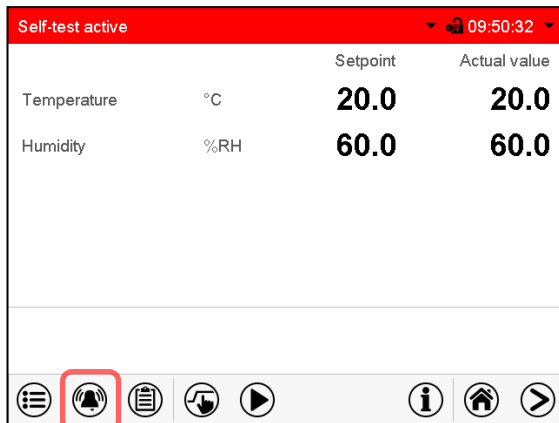

Alarm message “Self-test active”.  
 The self-test program is running. The indicated set-points are non-functional.  
 With enabled buzzer: the buzzer sounds.  
 Press the **Alarm** icon to access the “Active alarms” menu.

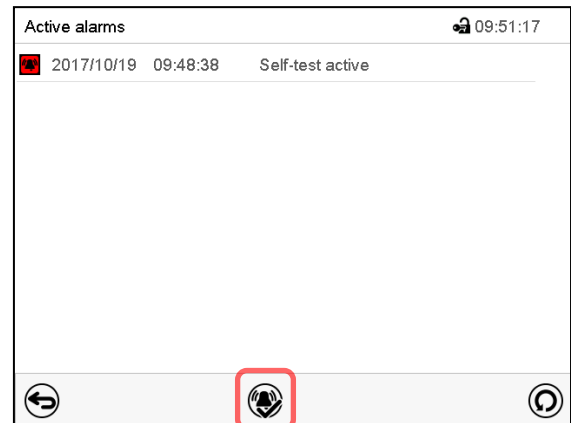

“Active alarms” menu.  
 The zero-voltage relay alarm output is not activated with the alarm message “Self-test active”.  
 Press the **Reset alarm** icon to mute the buzzer.

Do not open and do not turn off the chamber while self-test is running.

After an interruption of the voltage supply, the self-test restarts.

### Deactivating the self-test mode

Opening the chamber door will cancel the self-test.

This step allows you to cancel the self-test or deactivate the self-test mode after the chamber has completed the self-test or the self-test has been cancelled.

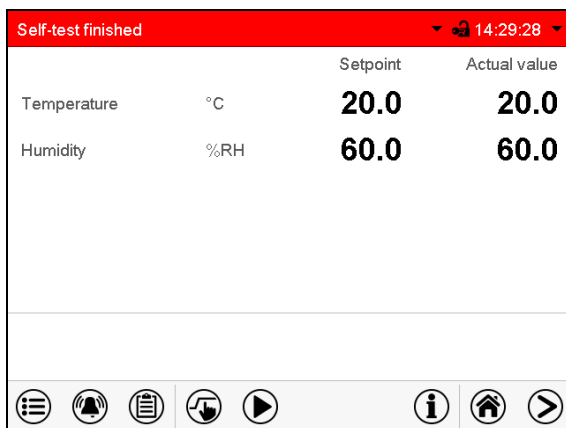

Alarm message “Self-test finished”.  
 The chamber is in Fixed-value mode and equilibrates to the indicated set-points.  
 With enabled buzzer: the buzzer sounds. Press the **Alarm** icon to access the “Active alarms” menu.  
 Press the **Reset alarm** icon to mute the buzzer.  
 The self-test is completed. You can now deactivate the self-test mode.

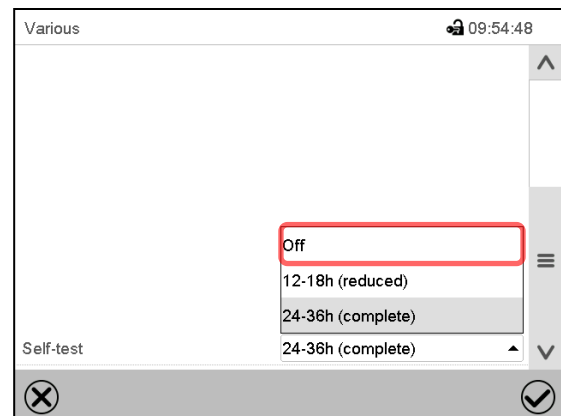

Submenu “Various”.  
 Select the setting “off” to deactivate the self-test mode after the self-test is completed or has been cancelled by opening the door, or to cancel a running self-test.  
 Confirm entry with **Confirm** icon.

The alarm messages “Self-test active” and “Self-test finished” do not activate the zero-voltage relay alarm output. They are listed in the Event list.

## 16. Chart recorder display

This view offers graphic representation of the measurement course. Data representation imitates a chart recorder and allows recalling any set of measured data at any point of time taken from the recorded period.

### 16.1 Views

	Press the <b>Change view</b> icon to access the pen recorder display.
--	---

#### 16.1.1 Show and hide legend

	<b>Show legend</b>		<b>Hide legend</b>
--	--------------------	--	--------------------

Press the **Show legend** icon to display the legend on the right side of the display

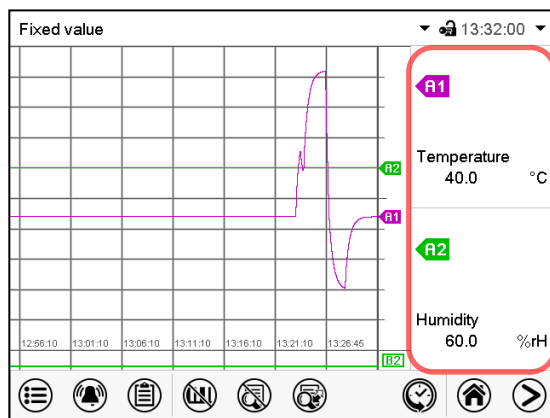

Legend shown on the right side of the display

#### 16.1.2 Switch between legend pages

	<b>Switch legend</b>
--	----------------------

Press the **Switch legend** icon to switch between the legend pages

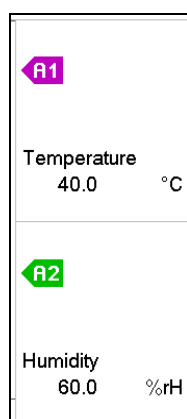

1<sup>st</sup> page

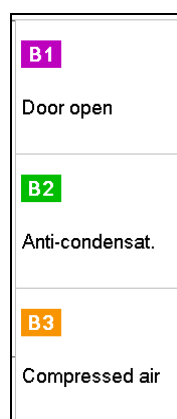

2<sup>nd</sup> page

Switching between the legend pages

### 16.1.3 Show and hide specific indications

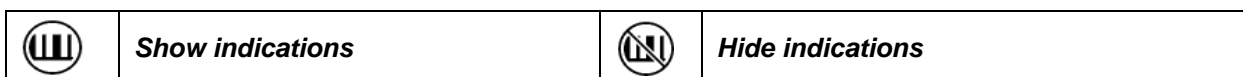

Press the **Show indications** icon to display the indications “Door open” (B1), “Anti-condensat.” (B2), “Compressed air” (B3)

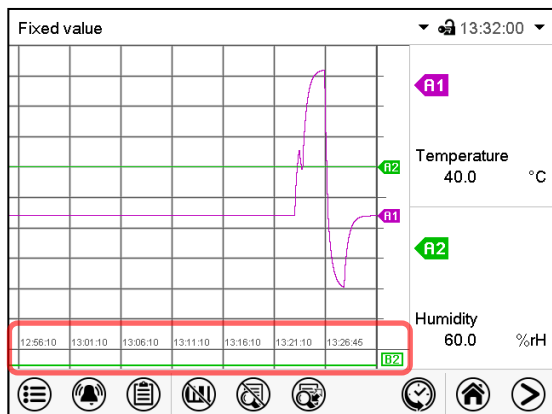

indications “Door open” (B1), “Anti-condensat.” (B2), “Compressed air” (B3) displayed.

### 16.1.4 History display

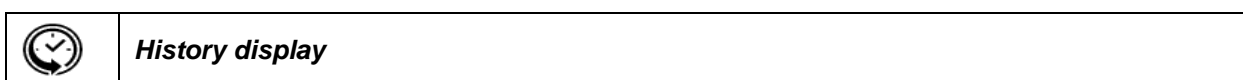

Press the **History display** icon to change to the history display.

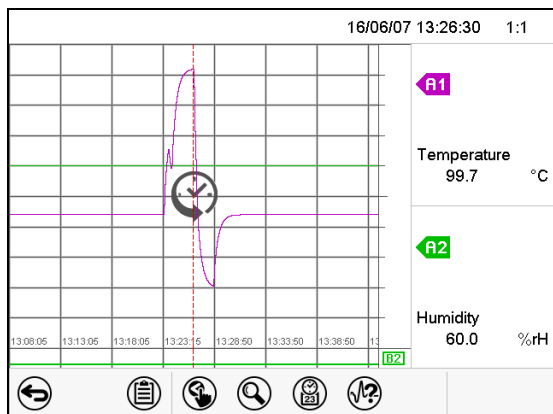

History display.  
 The chart recorder is paused. Data recording continues in the background.  
 Move the central red line by tapping and holding to the desired position.  
 The legend at the right side shows the values of the current line position.

Then further icons appear:

### History display: Curve selection



Press the **Curve selection** icon to access the “Curve selection” submenu.

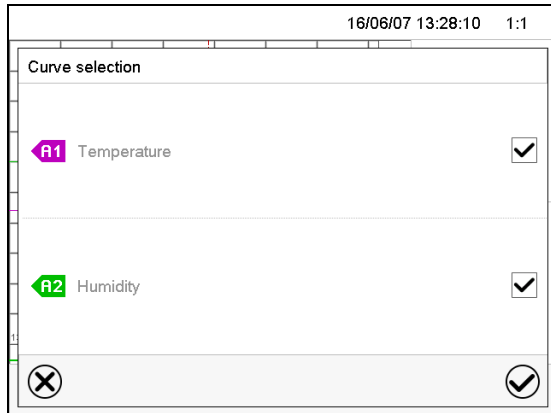

“Curve selection” submenu.

Select the curves to be displayed by checking the checkbox of the corresponding parameter. Press the **Confirm** icon

### History display: Search the required instant

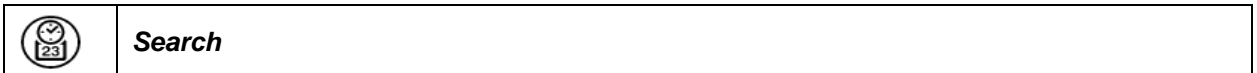

Press the **Search** icon to access the “Search” submenu.

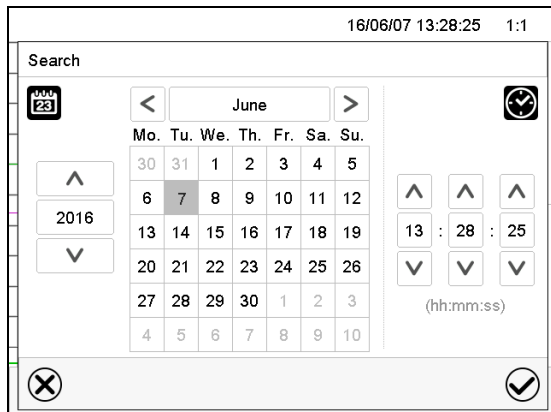

“Search” submenu.

Select the required instant by entering its date and time and press the **Confirm** icon

### History display: Zoom function

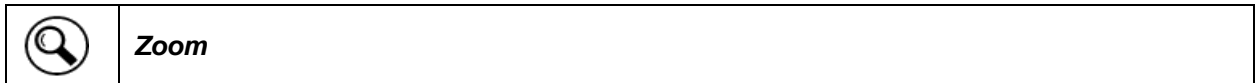

Press the **Zoom** icon to access the “Zoom” submenu.

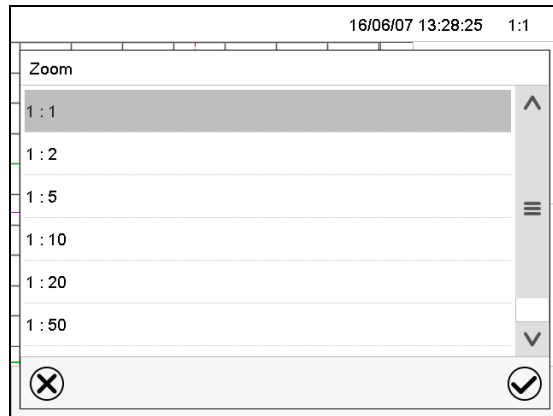

“Zoom” submenu.

Select the zoom factor and press the **Confirm** icon

### History display: Show and hide scroll buttons to scroll to an instant



Press the **Show scroll buttons** icon to access the “Page selection” submenu.

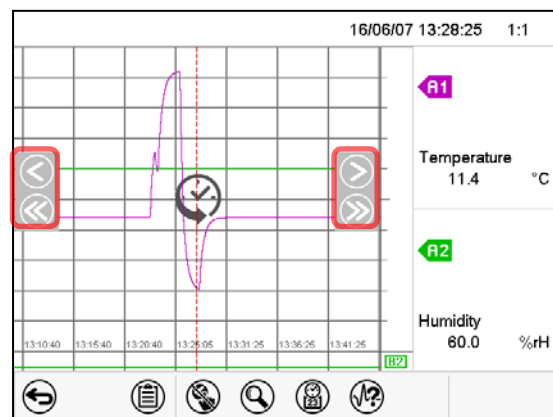

“Page selection” submenu.

Scroll buttons are shown on the left and on the right. Use them to move along the timeline.

## 16.2 Setting the parameters

This menu allows setting the storage interval, the type of values to be shown and the scaling of the temperature and humidity charts.

Path: **Main menu > Settings > Measurement chart**

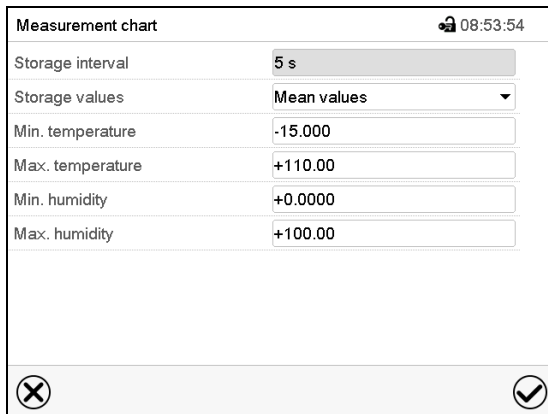

Measurement chart		08:53:54
Storage interval	5 s	
Storage values	Mean values	
Min. temperature	-15.000	
Max. temperature	+110.00	
Min. humidity	+0.0000	
Max. humidity	+100.00	

“Measurement chart” submenu.

- Select the field “Storage interval” and enter the desired storage interval. Confirm entry with **Confirm** icon.

The available presentation depends on the pre-selected storage rate. Factory setting: 60 seconds. This means the higher the storage rate, the more precisely but shorter the data representation will be.

- In the field “Storage values” select the desired value type to be displayed.

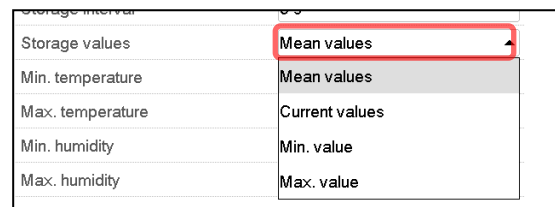

Storage interval	5 s
Storage values	Mean values
Min. temperature	Mean values
Max. temperature	Current values
Min. humidity	Min. value
Max. humidity	Max. value

- For scaling the representation select the desired minimum and maximum temperature or humidity value and enter the desired values. Temperature display range: -50 °C up to 180 °C. Humidity display range: 0% r.H. up to 100% r.H. Confirm entry with **Confirm** icon.

CAUTION	
	<p><b>Setting the storage rate or rescaling (minimum and/or maximum) clears the measured-value memory and the event list.</b></p> <p><b>Danger of information loss.</b></p>
	<p>➤ Change the storage rate or scaling <b>ONLY</b> if the previously registered data is no longer needed.</p>

After completing the settings, press the **Confirm** icon to take over the entries and exit the menu, **or** press the **Close** icon to exit the menu without taking over the entries.



## 17. Humidification / dehumidification system

The chamber is equipped with a capacitive humidity sensor. This results in a regulatory accuracy of up to +/- 2.5 % r.h. of the set point. The temperature-humidity diagrams (Figure 19) show the possible working range for humidity.

- In the “setpoints” menu you can turn humidity control (humidification and dehumidification) on or off with the setting “Control on/off” (chap. 6.3).

With humidity control turned off, the humidification module cools down. After activation it will take up to 20 minutes until the humidification function is fully available again. This setting is required when operating the chamber without a water connection in order to avoid humidity alarms.

- Operation line “Humidity off” serves to turn off the humidification / dehumidification system in Fixed value operation (chap. 7.3, time program operation (chap. 9.7.3) and week program operation (chap. 10.6.5). This allows configuring the disconnection for individual program sections.

When the humidification / dehumidification system is turned off via operation line it remain on standby (filled and heated). Therefore it is immediately available after turning on.

When operating the chamber with activated humidity, humidity control turns off automatically at temperature set-points below 0 °C / 32 °F or above 95 °C / 203 °F. The information icon “Humidity off” is displayed in the screen header in Normal display. When the temperature setpoint is set back to the range from 0 °C / 32 °F to 95 °C / 203 °F, humidity control turns on again and the information icon “Humidity off” disappears.

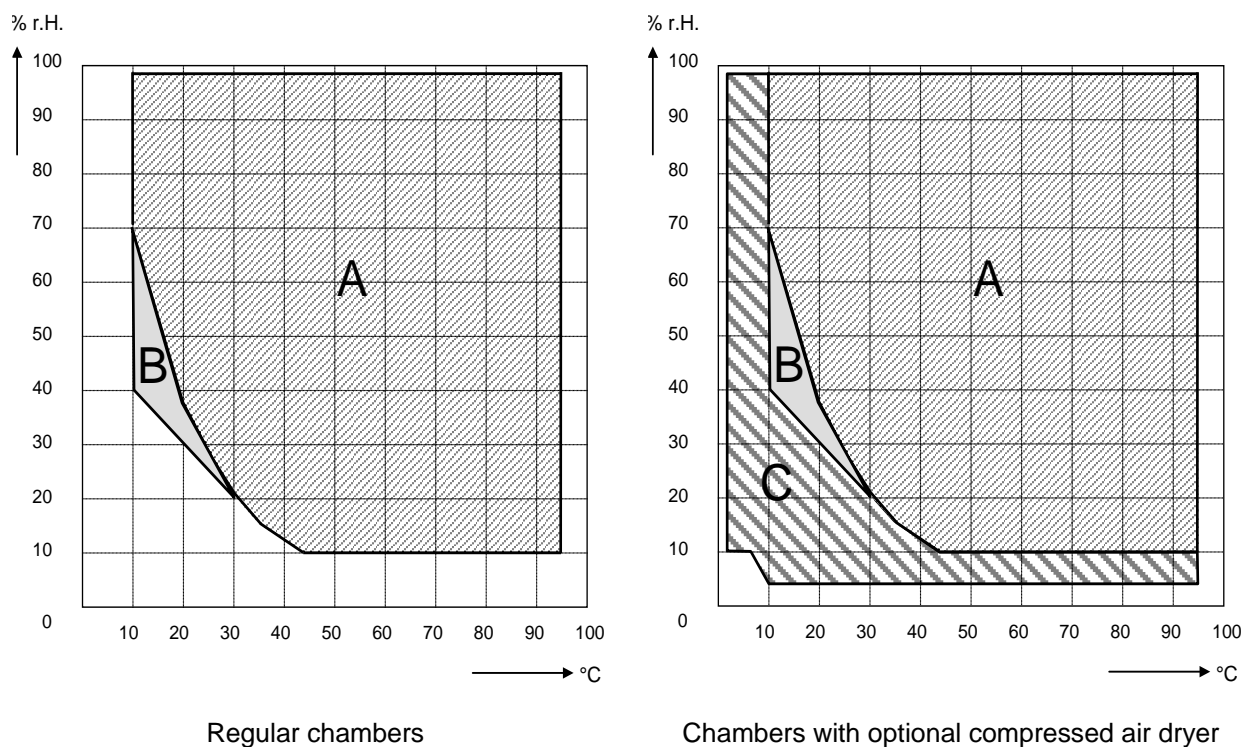



Figure 19: Temperature-humidity diagrams

Range A: Control range of temperature and relative humidity.

Range B: Discontinuous range (no continuous operation, max. 24 hours. Observe hints on defrosting, chap. 18)

Range C: Enlarged climatic range with optional compressed air dryer.

	<p>In climatic operation (with humidity) the preset temperature and humidity values must be situated within range A in order to achieve optimum regulation.</p> <p>In the short-term (max. 24 hours), set points in the discontinuous range (range B) can also be targeted.</p> <p>On the edges of the control range (ranges A + B) the regulatory accuracies of <math>\pm 2.5</math> % r.H. cannot be guaranteed.</p>
---	--

	<p>With temperature and humidity set-points outside ranges A and B, humidification control is automatically turned off. Humidity keeps being measured by the sensor and displayed, but may deviate in case of condensation.</p>
---	---

The chamber is equipped with a door heating system to prevent condensation in the door area.

	<p style="text-align: center;"><b>CAUTION</b></p> <p><b>Condensation by excess humidity.</b>  <b>Danger of corrosion on the housing after operating at humidity values &gt; 70 % r.h. for a long period.</b></p> <p>➤ Dry the chamber completely before shut-down:</p> <ul style="list-style-type: none"> <li>• Set the humidity to 0 % r.h. The humidity system must be activated.</li> <li>• Set the temperature set point to 60 °C / 140°F (Manual mode). Let the chamber operate for approx. 2 hours with closed door. Remove the access port plugs.</li> <li>• Only then, shut down the chamber at the main power switch (1) and close the water supply tap.</li> </ul>
---	--

	<p>Having turned off the chamber by the main power switch (1), always close the water supply tap.</p>
---	---

If you operate the chamber at high humidity and then immediately turn off the chamber, the internal wastewater collector may overflow due to the condensate. This may lead to the emergence of water at the chamber.

	<p style="text-align: center;"><b>CAUTION</b></p> <p><b>Overflow of the internal wastewater tank due to condensate.</b>  <b>Emergence of water at the chamber.</b></p> <p>⊘ Following high humidity operation, do NOT directly turn off the chamber.</p> <p>➤ Pump off the condensate before shut-down:</p> <ul style="list-style-type: none"> <li>• Set the humidity to 0 % r.h. The humidity system must be activated. Operate the chamber for at least 2 hours.</li> <li>• Only then, shut down the chamber at the main power switch (1) and close the water supply tap.</li> </ul>
---	--

## 17.1 Function of the humidifying and dehumidifying system

### Humidifying system

The humidifying and dehumidifying system is located in the humidity generation module. In a cylindrical container with a volume of approx. 2 liters an electrical resistance heating evaporates water. The water content is kept exactly at the boiling point, and thus steam can be immediately generated in sufficient quantity for rapid humidity increases or for compensation of humidity losses, e.g. by door openings. Condensation forming on the outer walls of the useable volume is led through a water drain in the outer chamber into the wastewater can which is pumped off automatically to the wastewater pipe when required.

### 17.1.1 Freshwater

**MKF 56:** You can supply the chamber with freshwater via a water pipe or by manually filling an external freshwater can (option, chap. 21.9). You can mount the can on the rear of the chamber or place it next to the chamber.

**MKF/MKFT 115, 240, 720:** You can supply the chamber with freshwater via a water pipe or by manually filling the internal freshwater can. It is not necessary to switch between both possibilities. When connecting to a water pipe, the water can automatically fills up. The can is located behind the right door of the humidity generation module.

	<p><b>In order to ensure accurate humidifying, observe the following points with regard to the freshwater supply:</b></p> <ul style="list-style-type: none"> <li>• Supply pressure 1 to 10 bar when connecting to a water pipe</li> <li>• Water type: deionized (demineralized) water, see chap. 4.2.</li> <li>• To ensure humidification during 24 hours even at high humidity set-points with manual water supply, we recommend filling the freshwater can at the end of each day.</li> <li>• Water intake temperature NOT below +5 °C / 41 °F and not exceeding 40 °C / 104 °F.</li> </ul>
---	---

	<p>BINDER GmbH is NOT responsible for the water quality provided by the customer. Any problems and malfunctions that might arise following use of water of deviating quality is excluded from liability by BINDER GmbH.</p>
---	---

#### 17.1.1.1 Automatic freshwater supply via water pipe

With this type of supply, the humidity system is continuously functional.

**MKF/MKFT 115, 240, 720:** The correct water supply can be monitored at the internal water can, where the water is intermediately stored also if a water pipe is connected. The correct filling level is automatically maintained at ½ to ¾ of the maximum level.

#### 17.1.1.2 Manual fresh water supply via external freshwater can (option for MKF 56)

With this type of supply, the humidity system is functional only if the water can is sufficiently filled. Check the filling level daily. The water reserve in the can is sufficient for a period, which may last between one and several days, depending on the humidity demand (entered humidity set-point and number of door openings).

For installation please refer to chap. 21.9.

#### 17.1.1.3 Manual fresh water supply via internal freshwater can (MKF/MKFT 115, 240, 720)

With this type of supply, the humidity system is functional only if the water can is sufficiently filled. Check the filling level daily. The water reserve in the water can is sufficient for a period, which may last between one and several days, depending on the humidity demand (entered humidity set-point and number of door openings). Fill the can up to the maximum level mark only. The cover of the water inlet valve must be screwed on the freshwater connection "IN" (15) (chap. 4.2.3).

### 17.1.2 Wastewater

The condensation water from the interior and, with MKF/MKFT 115, 240, 720, excess freshwater in the can (by manual excess filling or in case of fault) is collected in an internal can with a volume of approx. 1.5 liters. It is pumped off via the wastewater pipe.

#### Dehumidifying system

When the humidity system is activated, the chamber dehumidifies as needed in order to reach the entered humidity set-point inside the Control range of temperature and relative humidity (Figure 19).

Dehumidification occurs in case of need by means of a defined dew point undershoot of several evaporators of the refrigeration system. The condensate which forms is carried away as wastewater.

With temperature set-points outside the control range (hatched area in Figure 19), humidification and dehumidification are automatically turned off. If the humidity system is turned off while there are descending temperature curves, then operation of the refrigeration system may cause dehumidification of the charging material.

With humidity set-points outside the control range (hatched area in Figure 19), or with entry of set-point 0 % r.H., the humidification and dehumidification system is turned off even if the humidity system is activated.

For error indications concerning water supply and humidity system, see chap.11.1.3 and 24

## 18. Defrosting at refrigerating operation

BINDER alternating climate chambers are very diffusion-proof. To ensure high temperature precision there is no automatic cyclic defrosting device. However, at very low temperatures, the moisture in the air can condense on the evaporator plates leading to icing.

	Always close the door properly.
---	---------------------------------

#### Operation with temperature set-points above +5 °C / 41 °F at an ambient temperature of 20 °C / 68 °F:

The air defrosts the ice cover automatically. Defrosting is continually performed.

#### Operation with temperature set-points below +5 °C / 41 °F or in the discontinuous range (chap. 17):

The evaporator can cover with ice. Defrost the chamber manually.

	<p>With temperature set-points below +5 °C / 41 °F, regularly defrost the chamber manually:</p> <ul style="list-style-type: none"> <li>• Set the humidity to 0 % r.H. The humidity system must be activated.</li> <li>• Set the temperature to 60 °C / 140 °F (Manual Mode).</li> <li>• Let the chamber operate for approx. 1 hour with the door closed.</li> </ul>
---	---

	Too much ice on the evaporator is noticeable by reduced refrigerating performance.
---	--

When turning off the chamber following prolonged refrigerating below +5 °C / 41 °F, there is danger of overflowing due to uncontrolled defrosting of icing on the evaporator.

	CAUTION
	<p><b>Uncontrolled defrosting of icing on the evaporator.</b>  <b>Danger of overflowing.</b>          After several days of refrigerating below +5 °C / 41 °F:</p> <ul style="list-style-type: none"> <li>⊘ Do NOT directly turn off the chamber.</li> <li>➤ Manually defrost the chamber (see description above).</li> <li>➤ Then, shut down the chamber at the main power switch (1) and close the tap of the water supply.</li> </ul>

## 19. Anti-condensation protection via operation line

The anti-condensation protection condensates the chamber humidity at the coldest point in order to avoid the samples becoming wet from condensation. Anti-condensation protection is performed by the evaporator and can be programmed On/Off via operation line "Anti-condensation" in Fixed value and program modes.

	Use the anti-condensation protection only if absolutely necessary to prevent condensation on the charging material.
---	---

	Use the anti-condensation protection only when operating the chamber without humidification.
--	--

When the anti-condensation protection is enabled the refrigeration machine keeps operating within warming-up phases (On = refrigeration machine operating, Off = refrigeration machine off).

- **If possible, use the anti-condensation protection only during warm-up phases.** If necessary, you can also activate it during hold phases.
- **Do NOT use the anti-condensation protection above a temperature set-point of +20 °C / 68°F maximum.**

To obtain optimal warming results without condensation on the samples, program a heating gradient of approx. 0.5 °C/min.

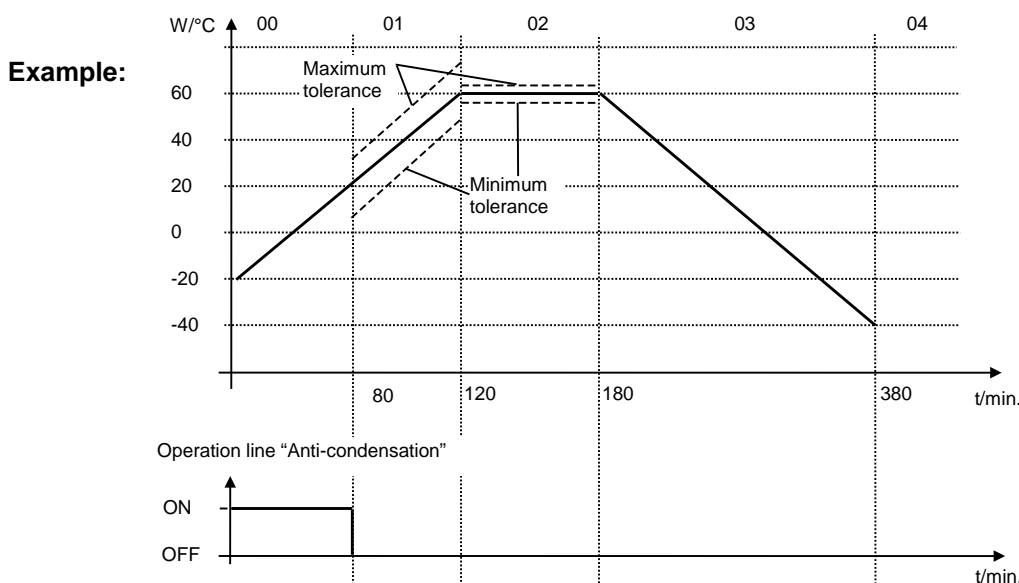

Depending on size, material, and shape of the charging material and on the heating-up rate, condensation may form despite the activated anti-condensation protection. This condensation is, however, reduced compared to the state without anti-condensation protection.

## 20. Zero-voltage switching outputs via operation lines

The chambers are regularly equipped with four zero-voltage switching outputs (DIN sockets (7) and (8) located in the lateral control panel).

The operation lines serve to switch any device connected to the zero-voltage relay output. They can be programmed On/Off in Fixed value and program modes.

Connection for operation lines "Switching output 1" and "Switching output 2" occurs via DIN socket (7), connection for operation lines "Switching output 3" and "Switching output 4" via DIN socket (8) in the lateral control panel:

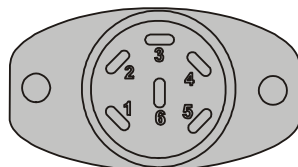

OUTPUT TRACK 1+2  
24V/MAX.2,5A

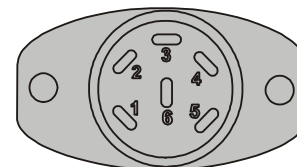

OUTPUT TRACK 3+4  
24V/MAX.2,5A

Figure 20: Pin configuration of DIN sockets (7) left and (8) right

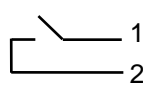
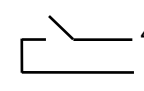

### DIN socket (7):

<p>Operation line "Switching output 1"</p>  <p>Pin 1: Pin Pin 2: Make</p>	<p>Operation line "Switching output 2"</p>  <p>Pin 4: Pin Pin 5: Make</p>
--	---

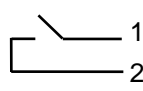
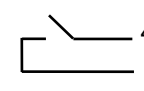
### DIN socket (8):

<p>Operation line "Switching output 3"</p>  <p>Pin 1: Pin Pin 2: Make</p>	<p>Operation line "Switching output 4"</p>  <p>Pin 4: Pin Pin 5: Make</p>
--	---

### Maximum loading capacity of the switching contacts: 24V AC/DC – 2.5 A

	 <b>DANGER</b>
<p><b>Electrical hazard.</b> <b>Danger of death.</b> <b>Damage to switching contacts and connection socket.</b></p> <ul style="list-style-type: none"> <li>⊘ Do NOT exceed the maximum switching load of 24V AC/DC – 2.5A.</li> <li>⊘ Do NOT connect any devices with a higher loading capacity.</li> </ul>	

## 21. Options

### 21.1 Communication software APT-COM™ 3 DataControlSystem (option)

The chamber is regularly equipped with an Ethernet interface (5) that can connect the BINDER communication software APT-COM™ 3 DataControlSystem. The MAC Address is indicated in the "Device info" controller menu (chap. 14.5.2.2). The actual temperature and humidity values are given at adjustable intervals. Programming can be performed graphically via PC. Up to 30 chambers with RS 422 interface can be cross-linked. For further information on networking, please refer to the operating manual of the BINDER communication software APT-COM™ 3.

### 21.2 RS485 interface (option)

With this option, the chamber is equipped with an additional 2-wire RS485 serial interface (5a) that can connect the BINDER communication software APT-COM™ 3 DataControlSystem. The actual temperature and humidity values are given at adjustable intervals. For further information, please refer to the operating manual of the BINDER communication software APT-COM™ 3.

### 21.3 Data logger kits (option)

BINDER Data Logger Kits offer an independent long-term measuring system for temperature and humidity, available for different temperature ranges. According to the selected kit, the Data Logger can measure and record also the ambient temperature and humidity values via a second multi-function sensor.

BINDER Data Loggers are equipped with a keyboard and a large LCD display, alarm functions and a real-time function. Measurement data are recorded in the Data Logger and can be read out after the measurement via the RS232 interface of the Data Logger. It offers a programmable measuring interval and permits storing up to 64000 measuring values. Reading out is done with the Data Logger evaluation software. You can give out a combined alarm and status protocol directly to a serial printer.

**Data Logger Kit T 220:** Sensor for chamber temperature: Temperature range  $-90\text{ °C} / -130\text{ °F}$  up to  $+220\text{ °C} / 428\text{ °F}$ .

**Data Logger Kit TH 100:** Multi-function sensor for chamber temperature and humidity: Temperature range  $-40\text{ °C} / -40\text{ °F}$  up to  $+100\text{ °C} / 212\text{ °F}$ , humidity range 0% r.H. up to 100% r.H.

**Data Logger Kit TH 100/70:** Multi-function sensor for chamber temperature and humidity: Temperature range  $-40\text{ °C} / -40\text{ °F}$  up to  $+100\text{ °C} / 212\text{ °F}$ , humidity range 0% r.H. up to 100% r.H. Multi-function sensor for ambient temperature and humidity: Temperature range  $-40\text{ °C} / -40\text{ °F}$  up to  $70\text{ °C} / 158\text{ °F}$ , humidity range 0% r.H. up to 100% r.H.



For detailed information on installation and operation of the BINDER Data Logger, please refer to the mounting instructions Art. No. 7001-0204 and to the original user manual of the manufacturer, supplied with the data logger.

## 21.4 Analog outputs for temperature and humidity (option)

With this option, the chamber is equipped with analogue outputs 4-20 mA for actual value and set-point value of temperature and of humidity. These outputs allow transmitting data to external data registration systems or devices.

The connection “analog outputs for temperature” is realized as a DIN socket (9) in the lateral control panel as follows:

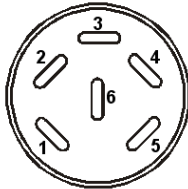

### ANALOG OUTPUT TEMPERATURE 4-20 mA DC

PIN 1: Temperature actual value –  
PIN 2: Temperature actual value +  
PIN 4: Temperature set-point value –  
PIN 5: Temperature set-point value +

**MKF:** Temperature range: -40 °C / -40 °F up to +180 °C / -356 °F

**MKFT:** Temperature range: -70 °C / -94 °F up to +180 °C / -356 °F

A suitable DIN plug is enclosed.

Figure 21: Pin allocation of DIN socket (9) for option analog outputs for temperature

The connection “analog outputs for humidity” is carried out as a DIN socket (10) in the lateral control panel as following:

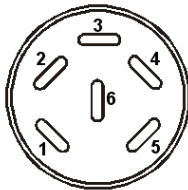

### ANALOG OUTPUT HUMIDITY 4-20 mA DC

PIN 1: Humidity actual value –  
PIN 2: Humidity actual value +  
PIN 4: Humidity set-point value –  
PIN 5: Humidity set-point value +

Humidity range: 0 % r.H. up to 100 % r.H.

A suitable DIN plug is enclosed.

Figure 22: Pin allocation of DIN socket (10) for option analog outputs for humidity



## 21.5 Compressed air connection (option)

This option permits directly connecting compressed air to the chamber.

### Requirements for the compressed air supplied directly to the chamber

- Quality of the air: DIN ISO 8573-1:2010 [2:2:1]
- Supply pressure: 6-8 bar domestic connection  
If a different connection pressure is required, please contact BINDER INDIVIDUAL Customized Solutions.
- Permissible temperature: +18 °C / 64.4 °F up to +32 °C / 89.6 °F.
- Air requirement: 15 m<sup>3</sup>/h (at normal pressure)
- Connection:

Connection is established to the coupling connector (20) in the rear panel : Standard quick acting closure socket for compressed air, nominal width 7.85 mm / 0.31 in.

### Activation:

Operation line "Compressed air valve" serves to open the solenoid valve of the compressed air connection (20).

## 21.6 Controlled compressed air dryer (option)

This option permits stronger dehumidification and thus the chamber can obtain lower humidity value, see modified temperature-humidity diagram (chap. 17). Chambers with a compressed air dryer are particularly suitable for compliance with the common automotive standards.

### Requirements for the compressed air supplied to the compressed air dryer:

- Quality of the air: DIN ISO 8573-1:2010 [4:4:3]



No water must enter into the compressed air dryer (danger of destruction)  
No oil must enter into the compressed air dryer. Oil is the main cause of damage for the compressed air dryer and shortens its life span.

- Supply pressure: 6-8 bar domestic connection  
If a different connection pressure is required, please contact BINDER INDIVIDUAL Customized Solutions.
- Permissible temperature: 10 °C / 50 °F up to +32 °C / 122 °F.
- Air requirement: 15 m<sup>3</sup>/h (at normal pressure)

### Connection:

The compressed air dryer is supplied ready assembled.

Connection of the gas cylinder to the compressed air dryer: Standard quick acting closure socket for compressed air, nominal width 7.85 mm / 0.31 in.

### Activation:

**MKF 56:** Switch (6) in the lateral control panel serves to activate the compressed air dryer.

**MKF/MKFT 115, 240, 720:** Operation line "Compr. air dryer" of the controller serves to activate the compressed air dryer.



Then operation line "Compressed air valve" serves to open the solenoid valve of the compressed air connection (20).

To turn on or off the operation lines (control contacts), please refer to chap. 7.3 for fixed value operation, 9.7.3 for time program operation, 10.6.5 for week program operation.

0 = operation line activated, 1 = operation line deactivated.

The desiccant cartridges must be replaced after no more than 17,500 operating hours or 2 years. The filter must be replaced after a maximum of 8,760 hours or 1 year. We recommend an annual maintenance interval.

An exchange is also necessary when the status display on the rear panel is lit or flashes in yellow. Check the status display approx. once per month.

	Normal operating state
	Filter elements and desiccant cartridges must be replaced. Contact BINDER Service
	Alarm. Contact BINDER Service

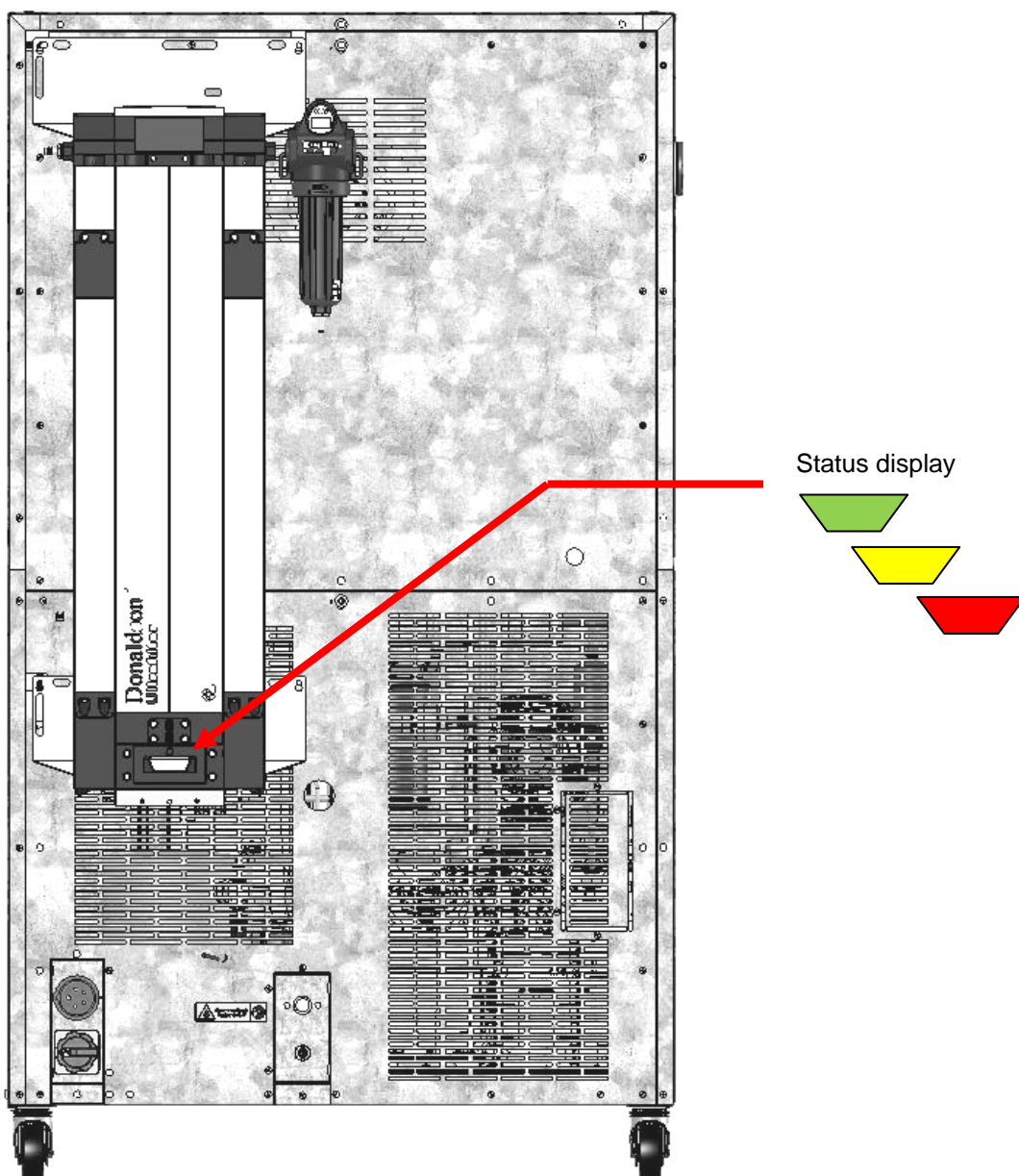

Figure 23: Rear chamber view with optional compressed air dryer (example: MKFT 115)

## 21.7 Water cooling (option)

**MKF 56, MKF / MKFT 115, 240:** The water cooling is turned on via the switch (3) in the lateral control panel. It reduces the heat, which is emitted during cooling operation to the ambient air and increases the cooling performance of the chamber (air cooling).

**MKF / MKFT 720:** The water cooling serves to cool the chamber instead of the air cooling and reduces the heat, which is emitted to the ambient air during cooling operation.

Retrofitting by the manufacturer is possible: The chamber must be returned to the BINDER factory for installation.

You can supply the chamber's humidity system with freshwater and drain the wastewater via a water pipe or manually with the internal water cans, like with the regular chamber. With the optional water cooling, the chamber is equipped with two additional connections for the inlet and outlet of the cooling water.

### Water connections

With the optional water cooling the chamber is supplied with cooling water via a freshwater pipe (max. inlet temperature: 10 °C / 50 °F).

- Connection of cooling water inlet: please refer to chap. 4.3.
- Connection of cooling water outlet: please refer to chap. 4.4.

## 21.8 Object temperature display with flexible Pt 100 temperature sensor (option)

The object temperature display enables the determination of the actual temperature of the charging material during the whole process. The object temperature is measured via a flexible Pt100 temperature sensor and can be viewed on the controller display. You can immerse the sensor top protective tube of the flexible Pt 100 into liquid substances.

Fixed value		09:05:00	
		Setpoint	Actual value
Temperature	°C	<b>10.0</b>	<b>11.1</b>
Humidity	%RH	<b>90.0</b>	<b>98.1</b>
Obj. Temp.	°C		<b>10.6</b>

Normal display with object temperature display (sample values)

The object temperature data are put out together with the data of the temperature controller to the Ethernet interface as second measuring channel and can be documented by the communication software APT-COM™ (option, chap. 21.1) developed by BINDER.

### Technical data of the Pt 100 sensor:

- Three-wire technique
- Class B (DIN EN 60751)
- Temperature range up to 320 °C / 608°F
- Stainless steel protective tube with a length of 45 mm / 1.78 in, material no. 1.4501

## 21.9 External freshwater and wastewater cans (option for MKF 56)

If no suitable in-house water connection is available, you can manually supply water by filling the optional external freshwater can. There is an additional external water can for the waste water. The volume of each can is 20 liters / 0.71 cu.ft.

You can place the cans next to the chamber.

### 21.9.1 Connecting the freshwater can and the pump

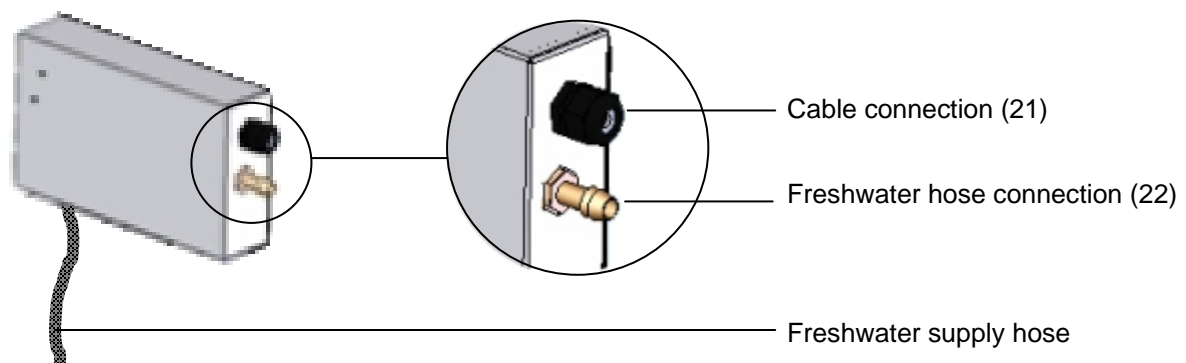

Figure 24: Water pump on the chamber rear panel

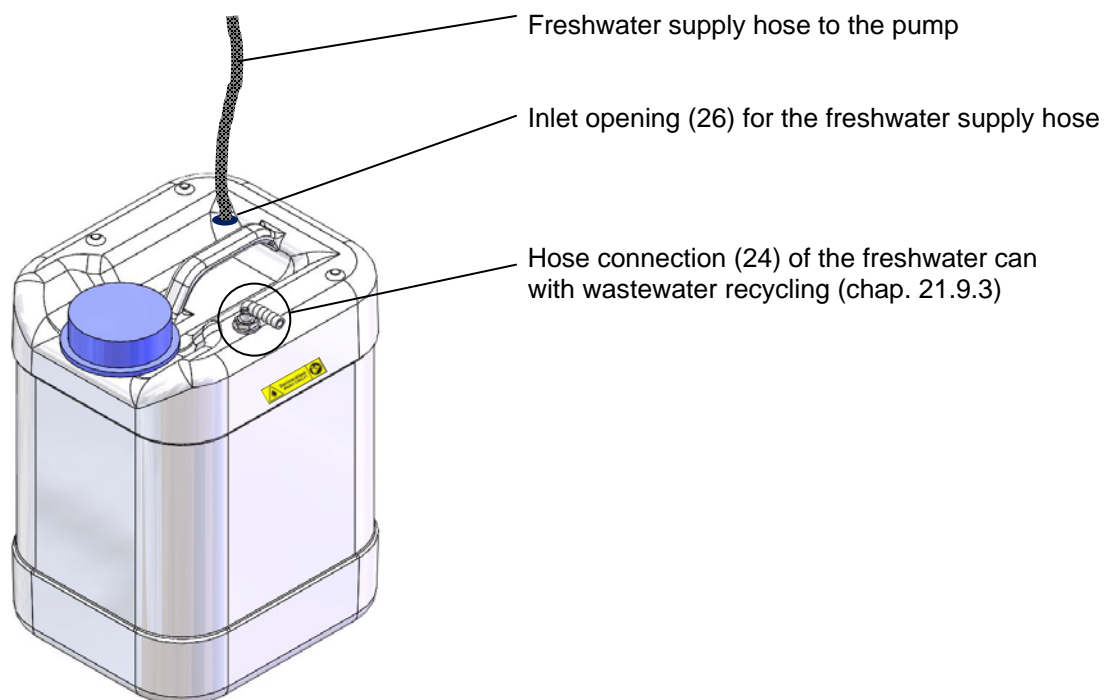

Figure 25: Freshwater can

#### Hose between the pump and the freshwater can

The freshwater supply hose is located at the bottom of the pump. Lead it through the inlet opening (26) into the freshwater can. The end of the hose must be placed at the bottom of the can.

### Cable connection between the pump and the climatic chamber

Connect the cable plug from the cable connection (21) on the pump to the socket (18) at the rear of the chamber.

The socket (18) is marked with a sticker:

**WATER TANK**  
**24 VDC/MAX 0.2A**

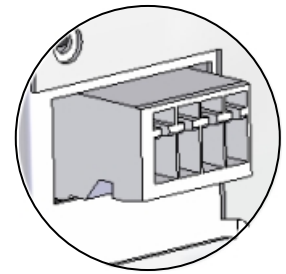

Socket (18)

### Hose connections between the pump and the climatic chamber

Plug the freshwater hose into the hose connection (22) on the pump and secure it with a hose clamp. You can use a part of the standard supplied water hose.

Screw the hose nozzle (brass) to the free edge of the hose and screw it directly onto the freshwater connection "IN" (15) at the rear of the chamber.

When the freshwater can is empty, the message "Freshwater supply" will be displayed on the controller (chap. 11.1.3), the buzzer sounds, and the humidification module turns off. After acknowledging the alarm, the humidification module tries to fill up and start operating.



To guarantee humidification during 24 hours even at high humidity set-points with manual water supply, we recommend filling the freshwater can (option) at the end of each day.

## 21.9.2 Connecting the wastewater can

### Hose connection

Plug the wastewater hose to the hose connection (23) of the wastewater can and secure it with a hose clamp. You can use a part of the standard supplied water hose.

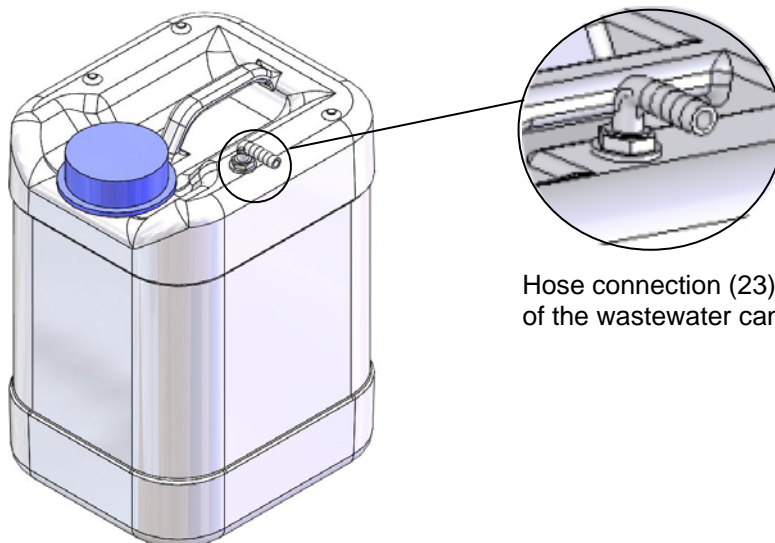



Hose connection (23)  
of the wastewater can

Figure 26: Wastewater can

Plug the free hose edge to the wastewater connection "OUT" (14) at the rear of the chamber and secure it with a hose clamp.

For emptying the wastewater can disconnect the hose first.

	<b>CAUTION</b>
	<p><b>Overflow of the wastewater can.</b>  <b>Damage to the surrounding.</b></p> <ul style="list-style-type: none"> <li>➤ Empty the wastewater can in a timely manner before it is full.</li> </ul>

	<p>Bringing a source of humidity into the inner chamber may increase wastewater production. Regularly check the filling level of the wastewater can.</p>
---	--

### 21.9.3 Connecting with wastewater recycling

When the chamber interior is clean, you can reuse the wastewater from the chamber. Connect the wastewater connection "OUT" (14) of the chamber with the hose connection (24) of the freshwater can. The wastewater can is not used in this case.

	<b>CAUTION</b>
	<p><b>Soiling of the vapor humidification system.</b>  <b>Damage to the chamber.</b></p> <ul style="list-style-type: none"> <li>➤ Reuse wastewater ONLY with a clean chamber interior.</li> <li>➤ In case of soiling / contamination of the interior, conduct the wastewater to the wastewater connection or use the wastewater can.</li> </ul>

#### Cable connection between the pump and the climatic chamber

Connect the cable plug from the cable connection (21) on the pump to the socket (18) at the rear of the chamber as described in chap. 21.9.1.

#### Hose connection between the wastewater hose of the climatic chamber and the freshwater can

Plug the wastewater hose into the hose connection (24) of the freshwater can and secure it with a hose clamp. You can use a part of the standard supplied water hose.

Plug the free hose edge to the wastewater connection "OUT" (14) at the rear of the chamber and secure it with a hose clamp.

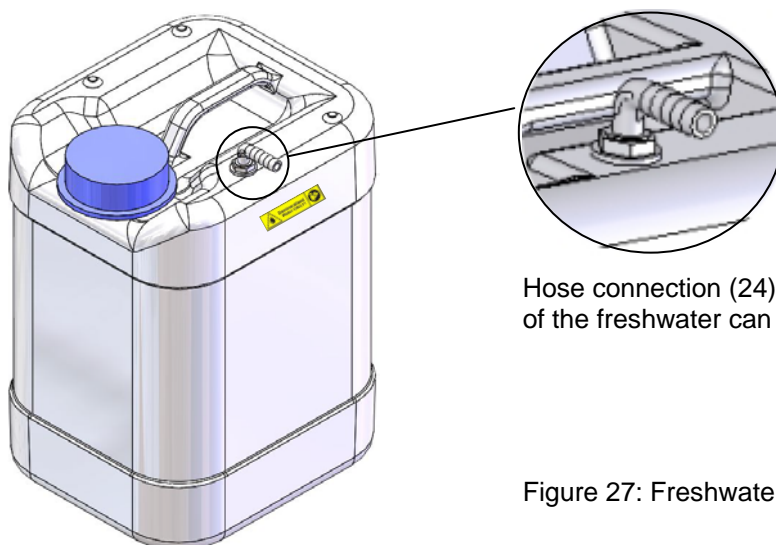



Figure 27: Freshwater can

	<p>Bringing a source of humidity into the inner chamber may increase wastewater production. Regularly check the filling level of the freshwater can.</p>
---	--





## 21.10 BINDER Pure Aqua Service (option)

The optional BINDER water treatment system (disposable system) serves to treat tap water. The lifetime depends on water quality and the amount of treated water. The measuring equipment to assess the water quality is reusable.

	<p>For detailed information on operating the water treatment system BINDER Pure Aqua Service and its function, please refer to the operating manual, supplied with BINDER Pure Aqua Service.</p>
---	--

## 22. Maintenance, cleaning, and service

### 22.1 Maintenance intervals, service

	 <b>DANGER</b>
	<p><b>Electrical hazard.</b> <b>Danger of death.</b></p> <ul style="list-style-type: none"> <li>⊘ The chamber must NOT become wet during operation or maintenance works.</li> <li>⊘ Do NOT remove the rear panel of the chamber.</li> <li>➤ Disconnect the chamber before conducting maintenance work. Turn off the main power switch and pull the power plug.</li> <li>➤ General maintenance work must be conducted by licensed electricians or experts authorized by BINDER.</li> <li>➤ Maintenance work at the refrigeration system must only be conducted by qualified personnel who underwent training in accordance with EN 13313:2010 (e.g. a refrigeration technician with certified expert knowledge acc. to Regulation (EC) n° 303/2008. Follow the national statutory regulations.</li> </ul>

Ensure regular maintenance work is performed at least once a year and that the legal requirements are met regarding the qualifications of service personnel, scope of testing and documentation. All work on the refrigeration system (repairs, inspections) must be documented in a service log book (equipment records).

In the course of this annual maintenance, a leak test shall be carried out in accordance with Regulation (EU) 517/2014 (Article 4 and Article 10 (1) (b)).

	<p>The warranty becomes void if maintenance work is conducted by non-authorized personnel.</p>
---	--

Have conducted regular maintenance work on the steam humidifier at least once a year. The operating behavior and the maintenance intervals of the humidifier essentially depend on the available water quality and the amount of steam produced in the meantime.

	<p>We recommend cleaning the condensers every 1 to 2 years. A qualified technician must perform cleaning.</p>
---	---

	<p>Replace the door gasket only when cold. Otherwise, the door gasket may become damaged.</p>
---	---

With an increased amount of dust in the ambient air, clean the condenser fan several times a year. We recommend checking the fan grid (behind the left maintenance access flap) every week. In case of visible dirt accumulation, disconnect the chamber and clean the fan grid by suction.

We recommend taking out a maintenance agreement. Please consult BINDER Service.

BINDER telephone hotline:	+49 (0) 7462 2005 555
BINDER fax hotline:	+49 (0) 7462 2005 93555
BINDER e-mail hotline:	service@binder-world.com
BINDER service hotline USA:	+1 866 885 9794 or +1 631 224 4340 x3 (toll-free in the USA)
BINDER service hotline Asia Pacific:	+852 390 705 04 or +852 390 705 03
BINDER service hotline Russia and CIS	+7 495 988 15 16
BINDER Internet website	<a href="http://www.binder-world.com">http://www.binder-world.com</a>
BINDER address	BINDER GmbH, post office box 102, 78502 Tuttlingen, Germany

International customers, please contact your local BINDER distributor.

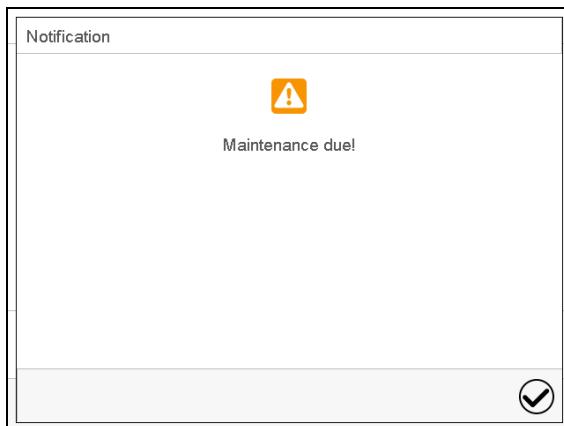

After 8760 operating hours or two years the following message appears:



After confirmation with the **Confirm** icon, the message window will pop up again every two weeks until it is reset by BINDER Service.

## 22.2 Cleaning and decontamination

Clean the chamber after each use to avoid potential corrosion damage by ingredients of the test material.

	 <b>DANGER</b>
	<p><b>Electrical hazard.</b> <b>Danger of death.</b></p> <ul style="list-style-type: none"> <li>⊘ Do NOT spill water or cleaning agents over the inner and outer surfaces.</li> <li>➤ Before cleaning, turn off the chamber at the main power switch and disconnect the power plug.</li> <li>➤ Completely dry the chamber before turning it on again.</li> </ul>

### 22.2.1 Cleaning

Disconnect the chamber from the power supply before cleaning. Pull the power plug.

	<p>The interior of the chamber must be kept clean. Thoroughly remove any residues of test material.</p>
---	---





Wipe the surfaces with a moistened towel. In addition, you can use the following cleaning agents:

Exterior surfaces inner chamber racks door gaskets	Standard commercial cleaning detergents free from acid or halides. Alcohol based solutions. We recommend using the neutral cleaning agent Art. No. 1002-0016.
Instrument panel	Standard commercial cleaning detergents free from acid or halides. We recommend using the neutral cleaning agent Art. No. 1002-0016.
Zinc coated hinge parts rear chamber wall	Standard commercial cleaning detergents free from acid or halides. Do NOT use a neutral cleaning agent on zinc coated surfaces.

Do not use cleaning agents that may cause a hazard due to reaction with components of the device or the charging material. If there is doubt regarding the suitability of cleaning products, please contact BINDER service.

	We recommend using the neutral cleaning agent Art. No. 1002-0016 for a thorough cleaning. Any corrosive damage that may arise following use of other cleaning agents is excluded from liability by BINDER GmbH. Any corrosive damage caused by a lack of cleaning, is excluded from liability by BINDER GmbH.
---	---

	<b>CAUTION</b>
	<b>Danger of corrosion.</b> <b>Damage to the chamber.</b> <ul style="list-style-type: none"> <li>∅ Do NOT use acidic or chlorine cleaning detergents.</li> <li>∅ Do NOT use a neutral cleaning agent on other kind of surfaces e.g., the zinc coated hinge parts or the rear chamber wall.</li> </ul>

	For surface protection, perform cleaning as quickly as possible. After cleaning completely remove cleaning agents from the surfaces with a moistened towel. Let the chamber dry.
---	--



	Soapsuds may contain chlorides and must therefore NOT be used for cleaning.
---	---

	With every cleaning method, always use adequate personal safety controls.
---	---

Following cleaning, leave the chamber door open or remove the access port plugs.

	The neutral cleaning agent may cause health problems in contact with skin and if ingested. Follow the operating instructions and safety hints labeled on the bottle of the neutral cleaning agent.
---	--

Recommended precautions: To protect the eyes use sealed protective goggles. Suitable protective gloves with full contact: butyl or nitrile rubber, penetration time >480 minutes.

	 <b>CAUTION</b> <b>Contact with skin, ingestion.</b> <b>Skin and eye damage due to chemical burns.</b> ∅ Do not ingest. Keep away from food and beverages. ∅ Do NOT empty into drains. ➤ Wear protective gloves and goggles. ➤ Avoid skin contact.
---	---

### 22.2.2 Decontamination

The operator must ensure that proper decontamination is performed in case a contamination of the chamber by hazardous substances has occurred.

Disconnect the chamber from the power supply prior to chemical decontamination. Pull the power plug.

Do not use decontamination agents that may cause a hazard due to reaction with components of the device or the charging material. If there is doubt regarding the suitability of cleaning products, please contact BINDER service.

You can use the following disinfectants:

Inner chamber	Standard commercial surface disinfectants free from acid or halides. Alcohol based solutions. We recommend using the disinfectant spray Art. No. 1002-0022.
---------------	---

	For chemical disinfection, we recommend using the disinfectant spray Art. No. 1002-0022. Any corrosive damage that may arise following use of other disinfectants is excluded from liability by BINDER GmbH.
---	--

	With every decontamination method, always use adequate personal safety controls.
---	--

In case of contamination of the interior by biologically or chemically hazardous material, there are two possible procedures depending on the type of contamination and charging material:

(1) Spray the inner chamber with an appropriate disinfectant.

Before start-up, the chamber must be absolutely dry and ventilated, as explosive gases may form during the decontamination process.

(2) If necessary, have strongly contaminated inner chamber parts removed by an engineer for cleaning, or have them exchanged. Sterilize the inner chamber parts in a sterilizer or autoclave.

	In case of eye contact, the disinfectant spray may cause eye damage due to chemical burns. Follow the operating instructions and safety hints labeled on the bottle of the disinfectant spray.
---	--



## 23. Disposal

### 23.1 Disposal of the transport packing

Packing element	Material	Disposal
Straps to fix packing on pallet (sizes 56, 115, 240)	Plastic	Plastic recycling
Wooden transport box (size 720; option for sizes 56, 115, 240) with metal screws	Non-wood (compressed matchwood, IPPC standard)	Wood recycling
	Metal	Metal recycling
Pallet with foamed plastic stuffing	Solid wood (IPPC standard)	Wood recycling
	PE foam	Plastic recycling
Shipping box (sizes 56, 115, 240) with metal clamps	Cardboard	Paper recycling
	Metal	Metal recycling
Top cover	Cardboard	Paper recycling
Edge protection	Styropor® or PE foam	Plastic recycling
Protection of doors and racks	PE foam	Plastic recycling
Upholstered transport piece (L-type profile) for door support	Steel or aluminum with plastic	Keep it for transportation purpose. Disposal: Metal recycling
Bag for operating manual	PE foil	Plastic recycling
Insulating air cushion foil (packing of optional accessories)	PE foil	Plastic recycling

If recycling is not possible, all packing parts can also be disposed of with normal waste.

### 23.2 Decommissioning

- Turn off the chamber at the main power switch On/Off (1) and disconnect it from the power supply.
- MKF/MKFT 115, 240, 720: Turn off the rear power switch (12).
- Close the tap used for the water supply.
- Turn off humidity control (chap. 6.3).
- Remove the water installation.
- Temporal decommissioning: See indications for appropriate storage, chap. 3.3.

In case of a prolonged temporal decommissioning: Leave the chamber door open or remove the access port plugs. For several weeks out of service, we recommend turning on the chamber every 3 days and operating it about 30 minutes in the cooling mode. This will ensure a quicker restart.

- Final decommissioning: Dispose of the chamber as described in chap. 23.3 to 23.5.

### 23.3 Disposal of the chamber in the Federal Republic of Germany

According to Annex I of Directive 2012/19/EU of the European Parliament and of the Council on waste electrical and electronic equipment (WEEE), BINDER devices are classified as “monitoring and control instruments” (category 9) only intended for professional use“. They must not be disposed of at public collecting points.

The chambers bear the symbol for the marking of electrical and electronic equipment manufactured / placed on the market in the EU after 13 August 2005 and be disposed of in separate collection according to Directive 2012/19/EU on waste electrical and electronic equipment (WEEE) and German national law for electrical and electronic equipment (Elektro- und Elektronikgerätegesetz, ElektroG). WEEE marking: crossed-out wheeled bin with solid bar under. A significant part of the materials must be recycled in order to protect the environment.

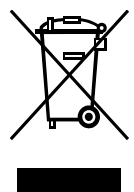



At the end of the device's service life, have the chamber disposed of according to the German national law for electrical and electronic equipment (Elektro- und Elektronikgerätegesetz, ElektroG from 20 October 2015, BGBl. I p. 1739) or contact BINDER service who will organize taking back and disposal of the chamber according to the German national law for electrical and electronic equipment (Elektro- und Elektronikgerätegesetz, ElektroG from 20 October 2015, BGBl. I p. 1739).

	<b>CAUTION</b>
	<p><b>Violation against existing law.</b></p> <ul style="list-style-type: none"> <li>⊘ Do NOT dispose of BINDER devices at public collecting points.</li> <li>➤ Have the device disposed of professionally at a recycling company which is certified according to the German national law for electrical and electronic equipment (Elektro- und Elektronikgerätegesetz, ElektroG from 20 October 2015, BGBl. I p. 1739).</li> <li style="text-align: center;"><i>or</i></li> <li>➤ Instruct BINDER Service to dispose of the device. The general terms of payment and delivery of BINDER GmbH apply, which were valid at the time of purchasing the chamber.</li> </ul>

Certified companies disassemble waste (used) BINDER equipment in primary substances for recycling according to Directive 2012/19/EU. The devices must be free from toxic, infectious or radioactive substances in order to eliminate any health hazards to the employees of the recycling companies.

	<p>Prior to handing the chamber over to a recycling company, it is the user's responsibility that it is free from toxic, infectious or radioactive substances.</p> <ul style="list-style-type: none"> <li>• Prior to disposal, clean all introduced or residual toxic substances from the chamber.</li> <li>• Prior to disposal, disinfect the chamber from all sources of infection. Be aware that sources of infection may also be located outside the inner chamber.</li> <li>• If you cannot safely remove all toxic substances and sources of infection from the chamber, dispose of it as "special" waste according to national law.</li> <li>• Fill out the contamination clearance certificate (chap. 28) and enclose it with the chamber.</li> </ul>
---	---

 	 <b>WARNING</b>
	<p><b>Contamination of the device with toxic, infectious or radioactive substances.</b></p> <p><b>Danger of intoxication.</b></p> <p><b>Danger of infection.</b></p> <ul style="list-style-type: none"> <li>⊘ NEVER take a chamber contaminated with toxic substances or sources of infection for recycling according to Directive 2012/19/EU.</li> <li>➤ Prior to disposal, remove all toxic substances and sources of infection from the chamber.</li> <li>➤ Dispose of a chamber from which all toxic substances or sources of infection cannot be safely removed as special waste according to national law.</li> </ul>

The refrigerants used 404a and R 23 (only MKFT) are not inflammable at ambient pressure. They must not escape into the environment. In Europe, recovery of the refrigerants R404a (GWP 3750) and R 23 (GWP 12100) is mandatory according to regulation No. 842/2006/EC. Ensure the compliance with the applicable legal requirements regarding qualification of staff, disposal, and documentation.

## 23.4 Disposal of the chamber in the member states of the EU except for the Federal Republic of Germany

According to Annex I of Directive 2012/19/EU of the European Parliament and of the Council on waste electrical and electronic equipment (WEEE), BINDER devices are classified as “monitoring and control instruments” (category 9) only intended for professional use“. They must not be disposed of at public collecting points.

The chambers bear the symbol for the marking of electrical and electronic equipment manufactured / placed on the market in the EU after 13 August 2005 and be disposed of in separate collection according to the Directive 2012/19/EU on waste electrical and electronic equipment (WEEE). WEEE marking: crossed-out wheeled bin with solid bar under.

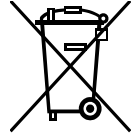



At the end of the device's service life, notify the distributor who sold you the device, who will take back and dispose of the chamber according to the Directive 2012/19/EU on waste electrical and electronic equipment (WEEE).

	<h3>CAUTION</h3>
	<p><b>Violation against existing law.</b></p> <ul style="list-style-type: none"> <li>⊘ Do NOT dispose of BINDER devices at public collecting points.</li> <li>➤ Have the device disposed of professionally at a recycling company that is certified according to conversion of the Directive 2012/19/EU into national law.</li> <li style="text-align: center;"><i>or</i></li> <li>➤ Instruct the distributor who sold you the device to dispose of it. The agreements apply that were agreed with the distributor when purchasing the chamber (e.g. his general terms of payment and delivery).</li> <li>➤ If your distributor is not able to take back and dispose of the chamber, please contact BINDER service.</li> </ul>



Certified companies disassemble waste (used) BINDER equipment in primary substances for recycling according to Directive 2012/19/EU. The devices must be free from toxic, infectious or radioactive substances in order to eliminate any health hazards to the employees of the recycling companies.

	<p>Prior to handing the chamber over to a recycling company, it is the user's responsibility that it is free from toxic, infectious or radioactive substances.</p> <ul style="list-style-type: none"> <li>• Prior to disposal, clean all introduced or residual toxic substances from the chamber.</li> <li>• Prior to disposal, disinfect the chamber from all sources of infection. Be aware that sources of infection may also be located outside the inner chamber.</li> <li>• If you cannot safely remove all sources of infection and toxic substances from the chamber, dispose of it as “special” waste according to national law.</li> <li>• Fill out the contamination clearance certificate (chap. 28) and enclose it with the chamber.</li> </ul>
---	---

 	 <h3>WARNING</h3>
	<p><b>Contamination of the device with toxic, infectious or radioactive substances.</b></p> <p><b>Danger of intoxication.</b></p> <p><b>Danger of infection.</b></p> <ul style="list-style-type: none"> <li>⊘ NEVER take a chamber contaminated with toxic substances or sources of infection for recycling according to Directive 2012/19/EU.</li> <li>➤ Prior to disposal, remove all toxic substances and sources of infection from the chamber.</li> <li>➤ Dispose of a chamber from which all toxic substances or sources of infection cannot be safely removed as “special” waste according to national law.</li> </ul>

The refrigerants used 404a and R 23 (only MKFT) are not inflammable at ambient pressure. They must not escape into the environment. In Europe, recovery of the refrigerants R404a (GWP 3750) and R 23 (GWP 12100) is mandatory according to regulation No. 842/2006/EC. Ensure the compliance with the applicable legal requirements regarding qualification of staff, disposal, and documentation.

### 23.5 Disposal of the chamber in non-member states of the EU

 	<b>CAUTION</b>
<p><b>Alteration of the environment.</b></p> <ul style="list-style-type: none"> <li>➤ For final decommissioning and disposal of the chamber, please contact BINDER service.</li> <li>➤ Follow the statutory regulations for appropriate, environmentally friendly disposal.</li> </ul>	

The main board of the chamber includes a lithium cell. Please dispose of it according to national regulations.

The refrigerants used 404a and R 23 (only MKFT) are not inflammable at ambient pressure. They must not escape into the environment. In Europe, recovery of the refrigerants R404a (GWP 3750) and R 23 (GWP 12100) is mandatory according to regulation No. 842/2006/EC. Ensure the compliance with the applicable legal requirements regarding qualification of staff, disposal, and documentation.

## 24. Troubleshooting

Fault description	Possible cause	Required measures
<b>General</b>		
Chamber without function.	No power supply.	Check connection to power supply.
	Wrong voltage.	Check power supply for correct voltage (chap. 4.8).
	Main power switch (1) not turned on	Turn on the main power switch (1).
	<b>MKF/MKFT 115, 240, 720:</b> Rear power switch (12) not turned on.	Turn on the rear power switch (12).
	Chamber fuse has responded.	Check chamber fuse and replace it if appropriate. If it responds again, contact BINDER service.
	Controller defective.	Contact BINDER service.
	Nominal temperature exceeded by 20 °C due to chamber failure. Over temperature protective device (class 1) responds.	
<b>Heating</b>		
Chamber heating permanently, set-point not maintained.	Semiconductor relay defective.	Contact BINDER service.
	Pt 100 sensor defective	
	Controller defective.	
	Controller not adjusted.	Calibrate and adjust controller.
Chamber doesn't heat up.	Heating element defective.	Contact BINDER service.
	Semiconductor relay defective	
Chamber doesn't heat up when turned on. Safety controller responds.	Inner chamber temperature has reached the safety controller setpoint. Safety controller set too low.	Acknowledge the alarm on the controller. Check temperature setpoint setting. If appropriate, select suitable safety controller setpoint (chap. 12.2).
	Safety controller (chap. 12.2) defective.	Contact BINDER service.
Safety controller class 2 responds.	Limit temperature reached.	Acknowledge the alarm on the controller. Disconnect the chamber from the power supply and let it cool down. Detect cause and remove it. Start up the chamber and check control functions. If appropriate, select suitable limit value.
Over-/under temperature safety device class 2 (option) responds.	Limit temperature reached.	Acknowledge the alarm on the controller. Disconnect the chamber from the power supply and let it cool down. Detect cause and remove it. Press button "RESET CL 2.0" (2). Start up the chamber and check control functions. If appropriate, select suitable limit value.



Fault description	Possible cause	Required measures
<b>Refrigerating performance</b>		
No or low refrigerating performance.	Ambient temperature > 25 °C / 77°F (chap.3.4).	Select cooler place of installation.
	Combination of temperature/humidity values not in the optimum range (see temperature humidity diagram, Figure 19).	Select combination of temperature/humidity values in the optimum range (chap. 17).
	Compressor not turned on.	Contact BINDER service.
	Electro-valves defective.	
	No or not enough refrigerant.	
No refrigerating performance; information message "Preheat phase" on the controller display.	<b>MKF 56:</b> Main power switch (1) turned on less than 1 hour before operating the chamber.	Turn on the main power switch (1) at least one hour before operating the chamber.
	<b>MKF / MKFT 115, 240, 720:</b> Main power switch (1) and/or rear power switch (12) turned on less than 1 hour before operating the chamber.	Turn on the main power switch (1) and/or the rear power switch (12) at least one hour before operating the chamber.
<b>Condensation</b>		
Condensation at the samples.	Heating-up phase without anti-condensation protection.	Use the anti-condensation protection (chap. 19).
	Heating up very fast.	Select lower heating up speed (ramp).
Condensation or icing at the sides of the inner chamber.	Set-point for a long time below ambient temperature, icing in the preheating chamber.	Defrost the chamber (chap. 18).
Condensation at the samples or at the sides of the inner chamber; information message "Preheat phase" on the controller display.	<b>MKF 56:</b> Main power switch (1) turned on less than 1 hour before operating the chamber.	Turn on the main power switch (1) at least one hour before operating the chamber.
	<b>MKF / MKFT 115, 240, 720:</b> Main power switch (1) and/or rear power switch (12) turned on less than 1 hour before operating the chamber.	Turn on the main power switch (1) and/or the rear power switch (12) at least one hour before operating the chamber.
<b>Humidity</b>		
Humidity fluctuation: Control accuracy of +/- 2.5 % r.H. is not reached.	Door gasket defective.	Replace door gasket.
	Door opened very frequently.	Open doors less frequently.
Humidity fluctuation, together with temperature fluctuation > 1 °C with a set-point approx. 3 °C above ambient temperature.	Place of installation too hot.	Select cooler place of installation or contact BINDER service.
No or low dehumidification.	Capillary tube blocked.	Contact BINDER service.
	Not enough refrigerant.	
No dehumidification; information message "Preheat phase" on the controller display.	<b>MKF 56:</b> Main power switch (1) turned on less than 1 hour before operating the chamber.	Turn on the main power switch (1) at least one hour before operating the chamber.
	<b>MKF / MKFT 115, 240, 720:</b> Main power switch (1) and/or rear power switch (12) turned on less than 1 hour before operating the chamber.	Turn on the main power switch (1) and/or the rear power switch (12) at least one hour before operating the chamber.
Icing at the sides of the inner chamber.	Set-point was too long below ambient temperature.	Defrost the chamber (chap. 18).

Fault description	Possible cause	Required measures
<b>Humidity (continued)</b>		
Condensation at the sides of the inner chamber.	Combination of temperature/humidity set-point values not in the optimum range (see temperature humidity diagram, Figure 19)	Select combination of temperature/humidity set-point values in the optimum range (chap. 17).
	Temperature set-point was too long below ambient temperature, icing in the preheating chamber.	Defrost the chamber (chap. 18)
	Combination of temperature/humidity set-point values leads to falling below the dew point.	Select suitable combination of temperature/humidity set-point values.
Low humidity and temperature accuracy	Fan speed has been reduced.	Set fan speed to 100%.
<b>Controller</b>		
No chamber function (dark display).	Display mode "Standby" active.	Press on touchscreen.
	Main power switch (1) not turned on	Turn on the main power switch (1).
	<b>MKF/MKFT 115, 240, 720:</b> Rear power switch (12) not turned on.	Turn on the rear power switch (12).
Menu functions not available.	Menu functions not available with current authorization level.	Log in with the required higher authorization or contact BINDER service to obtain an activation code (chap. 13.6).
No access to controller	Password incorrect.	Contact BINDER service.
Chart recorder function: measured-value memory cleared; information lost.	New setting of storage rate or scaling (minimum and/or maximum) (chap. 16.2).	Change the storage rate or scaling ONLY if the previously registered data are no longer required.
Controller does not equilibrate to setpoints entered in Fixed value operation mode	Controller is not in Fixed value operation mode.	Change to Fixed value operation mode.
	Humidity control is turned off.	Turn on humidity control (chap. 6.3).
Controller does not equilibrate to program set-points.	Controller is not in program operation mode, or program delay time is running.	Start the program again. If appropriate, wait for the program delay time.
Program duration longer than programmed.	Tolerances have been programmed.	For rapid transition phases, do NOT program tolerance limits in order to permit maximum heating, refrigerating, or humidification speed.
Program keeps the last program setpoint constant while in setting "ramp".	Program line with setting "ramp" is incomplete.	When programming with setting "ramp", define the end value of the desired cycle by adding an additional section with a section time of at least one second.
Ramp temperature transitions are only realized as steps.	Setting "step" has been selected.	Select setting "ramp".
Humidity alarm when operating without water connection.	Humidity control turned on.	Turn off humidity control (chap. 6.3).
Acknowledging the alarm does not cancel the alarm state.	Cause of alarm persists.	Remove cause of alarm. If the alarm state continues, contact BINDER service.
Alarm message: ---- or <<< or >>>	Sensor rupture between sensor and controller or Pt 100 sensor defective.	Contact BINDER service.
	Short-circuit.	

Fault description	Possible cause	Required measures
<b>Miscellaneous</b>		
Impaired valve function of hose burst protection.	Calcification.	Remove calcifications by citric acid or acetic acid solutions (chap. 4.6). Have a plumber inspect the valve.

	Only qualified service personnel authorized by BINDER must perform repair. Repaired chambers must comply with the BINDER quality standards.
---	--

## 25. Technical description

### 25.1 Factory calibration and adjustment

The chambers were calibrated and adjusted in the factory. Calibration and adjustment were performed using standardized test instructions, according to the QM DIN EN ISO 9001 system applied by BINDER (certified since December 1996 by TÜV CERT). All test equipment used is subject to the administration of measurement and test equipment that is also constituent part of the BINDER QM DIN EN ISO 9001 systems. They are controlled and calibrated to a DKD-Standard at regular intervals.

### 25.2 Over current protection

The chambers are equipped with an internal protection not accessible from outside. If these fuses have responded, please contact an electronic engineer or BINDER service.

### 25.3 Definition of usable volume

The usable volume illustrated below is calculated as follows:

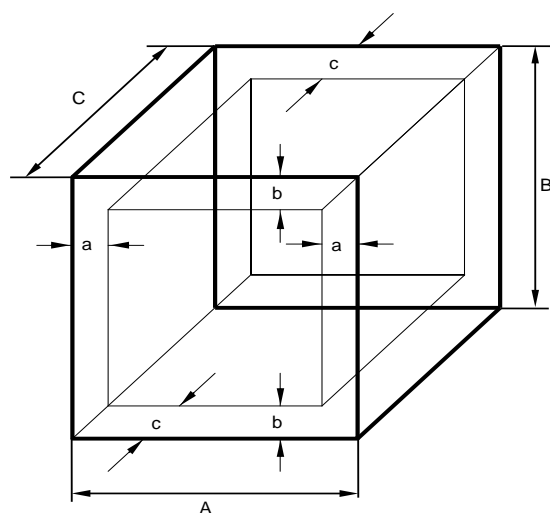

A, B, C = internal dimensions (W, H, D)

a, b, c = distance to wall

$$a = 0.1 * A$$

$$b = 0.1 * B$$

$$c = 0.1 * C$$

$$V_{USE} = (A - 2 * a) * (B - 2 * b) * (C - 2 * c)$$

Figure 28: Determination of the useable volume

**The technical data refers to the defined usable volume.**

	Do NOT place samples outside this usable volume. Do NOT load this volume by more than half to enable sufficient airflow inside the chamber. Do NOT divide the usable volume into separate parts with large area samples. Do NOT place samples too close to each other in order to permit circulation between them and thus obtain a homogenous distribution of temperature and humidity.
---	---

## 25.4 MKF (E4) technical data

Chamber size		56	115	240	720
<b>Exterior dimensions</b>					
Width, gross (including 18 mm / 0.7 in for 1 access port (MKF 56, 115, 240), 36 mm / 1.4 in for 2 access ports (MKF 720) with plug)	mm inch	745 29.33	1000 39.37	1135 44.69	1615 63.58
Height, gross (incl. castors)	mm inch	1450 57.09	1725 67.91	1715 67.52	2005 78.94
Depth, gross (incl. cable and door handle)	mm inch	835 32.87	915 36.02	1000 39.37	1230 48.43
Depth, gross (incl. cable and door handle) with optional compressed air dryer	mm inch	985 38.78	1085 42.72	1170 46.06	1400 55.12
Depth, gross (incl. cable and door handle) with voltage and frequency changer	mm inch	--	1530 60.24	1615 36.58	1845 72.64
Wall clearance rear (minimum)	mm / inch	300 / 11.81	300 / 11.81	300 / 11.81	300 / 11.81
Wall clearance rear with optional compressed air dryer or to set up the voltage and frequency changer (minimum)	mm inch	1000 39.37	1000 39.37	1000 39.37	1000 39.37
Wall clearance sides (minimum)	mm / inch	200 / 7.87	200 / 7.87	200 / 7.87	200 / 7.87
Window width	mm / inch	288 / 11.34	288 / 11.34	508 / 19.99	508 / 19.99
Window height	mm / inch	255 / 10.04	222 / 8.74	300 / 11.81	300 / 11.81
<b>Doors</b>					
Number of doors		1	1	1	1
<b>Interior dimensions</b>					
Width	mm inch	400 15.75	600 23.62	735 28.94	1200 47.24
Height	mm / inch	420 / 16.54	480 / 18.90	700 / 27.56	1020 / 40.16
Depth	mm / inch	318 / 12.52	400 / 15.75	443 / 17.44	600 / 23.62
Interior volume	l / cu.ft.	60 / 2.12	115 / 4.06	228 / 8.05	734 / 25.92
<b>Racks</b>					
Quantity of racks (regular)		1	1	1	1
Quantity of racks (max.)		4	4	6	11
Maximum load per rack	kg / lbs.	15 / 33	30 / 66	30 / 66	40 / 88
Maximum permitted total load	kg / lbs.	60 / 132	60 / 132	70 / 155	160 / 353
<b>Weight</b>					
Weight (empty)	kg / lbs.	175 / 386	280 / 617	360 / 794	590 / 1300
Weight (empty) with optional compressed air dryer	kg / lbs.	***	295 / 650	375 / 827	605 / 1334
<b>Temperature data (without humidity)</b>					
Temperature range	°C °F	-40 to +180 -40 to 356	-40 to +180 -40 to 356	-40 to +180 -40 to 356	-40 to +180 -40 to 356
Temperature fluctuation	+/- K	0.1 to 0.5	0.1 to 0.6	0.1 to 0.5	0.1 to 0.5
Temperature uniformity (variation)	+/- K	0.5 to 1.5	0.1 to 1.3	0.1 to 1.5	0.1 to 1.8
Average heating up time acc. to IEC 60068-3-5	K/min.	5.0	5.5	5.0	4.8
Average cooling down time acc. to IEC 60068-3-5	K/min.	5.0	4.5	5.0	4.8
Heating up from -40 °C to 180 °C	minutes	75	***	***	***
Cooling down time from 180 °C to -40 °C	minutes	90	***	***	***
Max. heat compensation at 25 °C / 77 °F	W	2500	2500	2800	6500

Chamber size		56	115	240	720
<b>Climatic data (with humidity)</b>					
Temperature range	°C °F	+10 to +95 50 to 203	+10 to +95 50 to 203	+10 to +95 50 to 203	+10 to +95 50 to 203
Temperature range with optional compressed air dryer	°C °F	0 to +95 32 to 203	0 to +95 32 to 203	0 to +95 32 to 203	0 to +95 32 to 203
Temperature fluctuation	+/- K	0.1 to 1.3	0.1 to 1.3	0.1 to 1.3	0.2 to 1.5
Humidity range	% r.H.	10 to 98	10 to 98	10 to 98	10 to 98
Humidity range with optional compressed air dryer	% r.H.	5 to 98	5 to 98	5 to 98	5 to 98
Humidity fluctuation	+/- % r.H.	≤ 2.5	≤ 2.5	≤ 2.5	≤ 2.5
Dew point temperature range	°C °F	+5 to +94 41 to 201	+5 to +94 41 to 201	+5 to +94 41 to 201	+5 to +94 41 to 201
Dew point temperature range with optional compressed air dryer	°C °F	-28 to +94 -18.4 to 201	-28 to +94 -18.4 to 201	-28 to +94 -18.4 to 201	-28 to +94 -18.4 to 201
Max. heat compensation at 25 °C / 77 °F and 90 % r.H. (without optional compressed air dryer)	W	400	400	400	1000
<b>Electrical data</b>					
System of protection acc. to EN 60529	IP	20	20	20	20
Nominal voltage (+/-10%) at 50 Hz power frequency	V	230	400	400	400
Current type		1N~	3N~	3N~	3N~
Nominal power	kW	2.80	4.80	6.80	11.00
Power plug		IEC connector plug (grounded)	CEE plug 5-poles 16 A	CEE plug 5-poles 16 A	CEE plug 5-poles 32 A
Over-voltage category acc. to IEC 61010-1		II	II	II	II
Pollution degree acc. to IEC 61010-1		2	2	2	2
Over-current release category B, internal	Amp	16	3 x 16	3 x 16	3 x 25
<b>Different electrical data for chambers constructed for the USA and Canada (model version MKF056-240V)</b>					
Nominal voltage (+/-10%) at 60 Hz power frequency	V	240	--	--	--
Current type		2~	--	--	--
<b>Electrical data of the voltage and frequency changer</b>					
IP-system of protection acc. to EN 60529	IP	--	23	23	23
Nominal voltage (+/-10%) at 60 Hz power frequency (input side)	V	--	480	480	480
Current type		--	3N~	3N~	3N~
Nominal power	kW	--	9	9	13
Over-voltage category acc. to IEC 61010-1		--	II	II	II
Pollution degree acc. to IEC 61010-1		--	2	2	2
Fuse	A	--	16	16	25
<b>Environment-specific data</b>					
Noise level (mean value)	dB(A)	59	62	65	65
Noise level with optional compressed air dryer (short-term) (mean value)	dB(A)	***	85	85	85
Noise level with voltage and frequency changer (mean value)	dB(A)	--	67	67	67
Energy consumption at +25 °C / 77 °F and 60 % r.H.	Wh/h	800	1250	1500	3900
Filling weight of refrigerant R 404A (GWP 3750)	kg / lbs.	1.50 / 33.1	2.00 / 4.41	2.20 / 4.85	5.00 / 11.02

\*\*\* Data not yet determined

**Note:** Chambers with voltage and frequency changer: Average heating up time reduced by 0.3 K/min each.

All technical data is specified for unloaded chambers with standard equipment at an ambient temperature of +22 °C +/- 3 °C / 71.6 °F +/- 5.4 °F and a power supply voltage fluctuation of +/-10%. Technical data is determined in accordance to BINDER Factory Standard Part 2:2015 and DIN 12880:2007.

**All indications are average values, typical for chambers produced in series. We reserve the right to change technical specifications at any time.**

	If the chamber is fully loaded, the specified heating up and cooling down times may vary according to the load.
---	---

	Bringing a source of humidity into the inner chamber will affect the minimum humidity specification and may affect the humidity accuracy.
---	---

## 25.5 MKFT (E4) technical data

Chamber size		115	240	720
<b>Exterior dimensions</b>				
Width, gross (including 18 mm / 0.7 in for 1 access port (MKFT 115, 240), 36 mm / 1.4 in for 2 access ports (MKFT 720), with plug)	mm / inch	1000 / 39.37	1135 / 44.69	1615 / 63.58
Height, gross (incl. castors)	mm / inch	1725 / 67.91	1940 / 76.38	2005 / 78.94
Depth, gross (incl. cable and door handle)	mm / inch	915 / 36.02	1000 / 39.37	1230 / 48.43
Depth, gross (incl. cable and door handle) with optional compressed air dryer	mm / inch	1085 / 42.72	1170 / 46.06	1400 / 55.12
Depth, gross (incl. cable and door handle) with voltage and frequency changer	mm / inch	1530 / 60.24	1615 / 36.58	1845 / 72.64
Wall clearance rear (minimum)	mm / inch	300 / 11.81	300 / 11.81	300 / 11.81
Wall clearance rear with optional compressed air dryer or to set up the voltage and frequency changer (minimum)	mm / inch	1000 / 39.37	1000 / 39.37	1000 / 39.37
Wall clearance sides (minimum)	mm / inch	200 / 7.87	200 / 7.87	200 / 7.87
Window width	mm / inch	288 / 11.34	508 / 19.99	508 / 19.99
Window height	mm / inch	222 / 8.74	300 / 11.81	300 / 11.81
<b>Doors</b>				
Number of doors		1	1	1
<b>Interior dimensions</b>				
Width	mm / inch	600 / 23.62	735 / 28.94	1200 / 47.24
Height	mm / inch	480 / 18.90	700 / 27.56	1020 / 40.16
Depth	mm / inch	400 / 15.75	443 / 17.44	600 / 23.62
Interior volume	l / cu.ft.	115 / 4.06	228 / 8.05	734 / 25.92
<b>Racks</b>				
Quantity of racks (regular)		1	1	1
Quantity of racks (max.)		4	6	11
Maximum load per rack	kg / lbs.	30 / 66	30 / 66	40 / 88
Maximum permitted total load	kg / lbs.	60 / 132	70 / 155	160 / 353
<b>Weight</b>				
Weight (empty)	kg / lbs.	330 / 728	415 / 915	635 / 1400
Weight (empty) with optional compressed air dryer	kg / lbs.	345 / 761	430 / 948	650 / 1433



Chamber size		115	240	720
<b>Temperature data (without humidity)</b>				
Temperature range	°C °F	-70 to +180 -94 to 356	-70 to +180 -94 to 356	-70 to +180 -94 to 356
Temperature fluctuation	± K	0.1 to 0.5	0.1 to 0.5	0.1 to 0.5
Temperature uniformity (variation)	± K	0.1 to 1.3	0.2 to 1.8	0.3 to 2.0
Average heating up time acc. to IEC 60068-3-5	K/min.	5.5	5.0	4.8
Average cooling down time acc. to IEC 60068-3-5	K/min.	4.2	4.2	4.0
Max. heat compensation at 25 °C / 77°F	W	1500	3000	5000
<b>Climatic data (with humidity)</b>				
Temperature range	°C °F	+10 to +95 50 to 203	+10 to +95 50 to 203	+10 to +95 50 to 203
Temperature range with optional compressed air dryer	°C °F	0 to +95 32 to 203	0 to +95 32 to 203	0 to +95 32 to 203
Temperature fluctuation	± K	0.1 to 1.0	0.1 to 1.5	0.1 to 1.0
Humidity range	% r.H.	10 to 98	10 to 98	10 to 98
Humidity range with optional compressed air dryer	% r.H.	5 to 98	5 to 98	5 to 98
Humidity fluctuation	± % r.H.	≤ 2.5	≤ 2.5	≤ 2.5
Dew point temperature range	°C °F	+5 to +94 41 to 201	+5 to +94 41 to 201	+5 to +94 41 to 201
Dew point temperature range with optional compressed air dryer	°C °F	-28 to +94 -18.4 to 201	-28 to +94 -18.4 to 201	-28 to +94 -18.4 to 201
Max. heat compensation at 25 °C / 77 °F and 90 % r.H. (without optional compressed air dryer)	W	400	400	800
<b>Electrical data</b>				
IP-system of protection acc. to EN 60529	IP	20	20	20
Nominal voltage (+/-10%) at 50 Hz power frequency	V	400	400	400
Current type		3N~	3N~	3N~
Power frequency	Hz	50	50	50
Nominal Power	kW	6.20	7.50	13.00
Power plug		CEE plug 5-poles 16 A	CEE plug 5-poles 16 A	CEE plug 5-poles 32 A
Over-voltage category acc. to IEC 61010-1		II	II	II
Pollution degree acc. to IEC 61010-1		2	2	2
Over-current release category B, 3 x internal	Amp	16	16	25
<b>Electrical data of the voltage and frequency changer</b>				
IP-system of protection acc. to EN 60529	IP	23	23	23
Nominal voltage (+/-10%) at 60 Hz power frequency (input side)	V	480	480	480
Current type		3N~	3N~	3N~
Nominal power	kW	9	9	13
Over-voltage category acc. to IEC 61010-1		II	II	II
Pollution degree acc. to IEC 61010-1		2	2	2
Fuse	A	16	16	25

Chamber size		115	240	720
<b>Environment-specific data</b>				
Noise level (mean value)	dB(A)	62	65	69
Noise level with optional compressed air dryer (short-term) (mean value)	dB(A)	85	85	85
Noise level with voltage and frequency changer (mean value)	dB(A)	67	67	67
Energy consumption at +25 °C / 77°F and 60 % r.H.	Wh/h	1250	1500	2200
Filling weight of refrigerant R 404A (1 <sup>st</sup> stage cooling, GWP 3750)	kg / lbs.	1.60 / 3.53	2.20 / 4.85	4.00 / 8.82
Filling weight of refrigerant R23 (2 <sup>nd</sup> stage cooling, GWP 12100)	kg / lbs.	0.32 / 0.71	0.40 / 0.88	0.87 / 1.92

**Note:** Chambers with voltage and frequency changer: Average heating up time reduced by 0.3 K/min each.

All technical data is specified for unloaded chambers with standard equipment at an ambient temperature of +22 °C +/- °C / 71.6 °F +/- 5.4 °F and a power supply voltage fluctuation of +/-10%. Technical data is determined in accordance to BINDER Factory Standard Part 2:2015 and DIN 12880:2007.

**All indications are average values, typical for chambers produced in series. We reserve the right to change technical specifications at any time.**

	If the chamber is fully loaded, the specified heating up and cooling down times may vary according to the load.
---	---

	Bringing a source of humidity into the inner chamber will affect the minimum humidity specification and may affect the humidity accuracy.
---	---

## 25.6 Equipment and options (extract)

	To operate the chamber, use only original BINDER accessories or accessories / components from third-party suppliers authorized by BINDER. The user is responsible for any risk arising from using unauthorized accessories.
---	---

Regular equipment
Microprocessor display program controller for temperature and humidity regulation
Electronically controlled humidifying and dehumidifying system with capacitive humidity sensor *) (humidity range, see diagram)
MKF/MKFT 115, 240, 720: Integrated freshwater can
MKF/MKFT 115, 240, 720: Alarm message in case of lack of water inside the freshwater can
Heated window and interior lighting
Programmable anti-condensation protection of charging material
Environmentally friendly refrigerants R404a (MKF / MKFT) and R 23 (MKFT)
Temperature safety device class 2 acc. to DIN 12880:2007
MKF/MKFT 115, 240, 720: socket 230 V AC, 1N ~ 50-60 Hz, max. load 500W, protection type IP 54
2 zero-voltage relay outputs, addressable via operation lines
Ethernet interface for computer communication
1 access port with silicone plug, diameter 50 mm / 1.97 in left (MKF / MKFT 56, 115, 240), 2 access ports with silicone plug, diameter 80 mm / 3.18 in left and right (MKF / MKFT 720)
Rack, stainless steel
Aeration / venting
Four castors (2 lockable)



\*) A water supply (1 to 10 bar) is necessary for the installation of the humidifying and de-humidifying system. If no suitable house water connection is available, you can manually supply water by filling a freshwater can (internal water can: regular with MKF/MKFT 115, 240, 720; external water can: option for MKF 56). Furthermore, a water drain in a max. distance of 3 meters / 9.8 ft. and a max. height of 1 meter / 3.3 ft. is required.

<b>Options / accessories</b>	
Additional rack, stainless steel	
Perforated rack, stainless steel	
Reinforced rack with 1 set of rack lockings	
Securing elements for additional fastening of racks (4 pieces)	
Lockable door	
Communication interface RS485	
2 zero-voltage relay outputs, addressable via operation lines	
BINDER Data Logger kit for temperature T 220 (chamber values), for temperature / humidity TH 100 (chamber values) or TH 100/70 (chamber and ambient values)	
Safety kit for water connection with hose burst protection device and reflux protection device, pre-mounted assembly (available via BINDER INDIVIDUAL customized solutions)	
Access ports 30 mm, 50 mm, 80 mm, 100 mm, 125 mm, left or right, with silicone plug	
Over-/under temperature safety device class 2	
Analogue outputs 4-20 mA actual and set-point values for temperature and humidity with 6 pole DIN socket, DIN plug included	
Object temperature display with flexible Pt100 temperature sensor	
Controlled compressed air dryer suitable for compliance with the common automotive standards	
Water cooling	
Notch-type access port 35 x 100 mm in the door	
MKF 56: External freshwater and wastewater cans (20 liters / 0.71 cu.ft. each)	
BINDER Pure Aqua Service	
Exchange cartridge for BINDER Pure Aqua Service	
MKF/MKFT 115, 240, 720: Water circle: condensate recycling	
Calibration of temperature and humidity including certificate	
Spatial temperature and humidity measurement including certificate	
Spatial temperature measurement acc. to DIN 12880 and humidity measurement with 9 measuring points at 25 °C / 77°F and 60% r.H. or at specified values, with measuring protocol and certificate	
Qualification folder	



If the refrigerating machine is continuously operated, the lifetime of the condenser-fan is 2.3 years.

## 25.7 Accessories and spare parts (extract)

	<p>BINDER GmbH is responsible for the safety features of the chamber only, provided skilled electricians or qualified personnel authorized by BINDER perform all maintenance and repair, and if components relating to chamber safety are replaced in the event of failure with original spare parts. The user is responsible for any risks arising from using unauthorized accessories / components.</p>
---	---

Chamber size	56	115	240	720
Description	Art. no.			
Rack, stainless steel	6004-0150	6004-0008	6004-0097	6004-0102
Perforated rack, stainless steel	6004-0182	6004-0030	8009-0447	8009-0511
Reinforced rack, stainless steel, with 1 set of rack lockings	8012-1091	8012-0709	8012-0605	8012-0684
Rack lockings (4 pieces)	8012-1092	8012-0620	8012-0620	8012-0620
Door gasket, silicone, inside	6005-0262	6005-0151	6005-0188	6005-0199
Door gasket, silicone, outside	6005-0263	6005-0152	6005-0157	6005-0173

Description	Art. no.
Plug for silicon access port d50	6016-0032
Plug for silicon access port d80	6016-0029
Water connection kit	8009-0135
Safety kit for water connection with hose burst protection device and reflux protection device	BINDER Individual Customized solutions
Data Logger Kit T 220	8012-0715
Data Logger Kit TH 100	8012-0718
Data Logger Kit TH 100/70	8012-0719
BINDER Pure Aqua Service	8012-0759
Exchange cartridge for BINDER Pure Aqua Service	6011-0165
Neutral cleaning agent, 1 kg	1002-0016

Validation service	Art. no.
Qualification folder IQ-OQ for MKF	8012-0865
Qualification folder IQ-OQ for MKFT	8012-0866
Qualification folder IQ-OQ-PQ for MKF	8012-0953
Qualification folder IQ-OQ-PQ for MKFT	8012-0954
Execution of IQ-OQ	DL420300
Execution of IQ-OQ-PQ	DL440500

Calibration service	Art. no.
Calibration of temperature and humidity including certificate (1 measuring point)	DL300301
Spatial temperature and humidity measurement including certificate (9 measuring points temperature, 1 measuring point humidity)	DL300309
Spatial temperature and humidity measurement including certificate (18 measuring points temperature, 1 measuring point humidity)	DL300318
Spatial temperature and humidity measurement including certificate (27 measuring points temperature, 1 measuring point humidity)	DL300327

For information on components not listed here, please contact BINDER Service.

## 25.8 MKF heating-up and cooling-down graphs

**Heating-up graph MKF 56**

Temp/°C

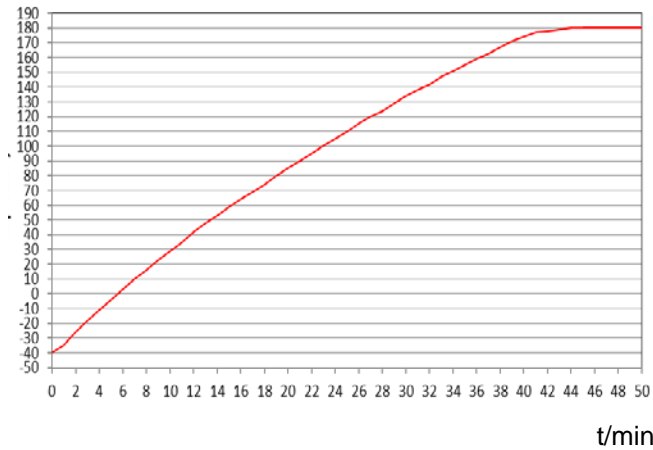

**Cooling-down graph MKF56**

Temp/°C

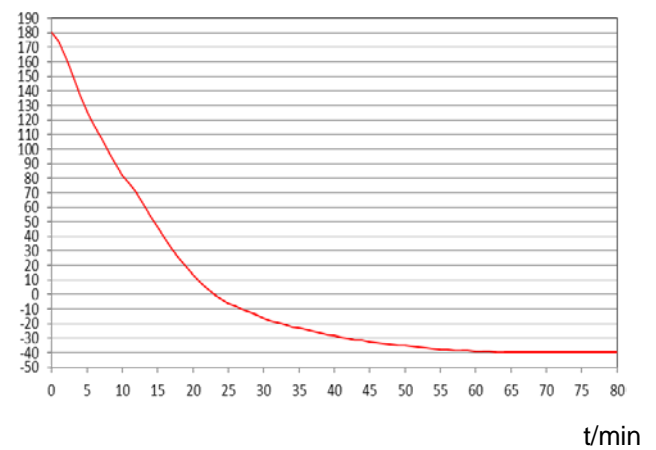

**Heating-up graph MKF 115**

Temp/°C

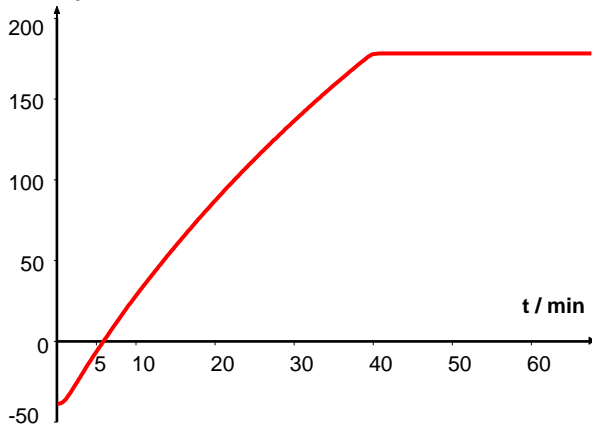

**Cooling-down graph MKF 115**

Temp/°C

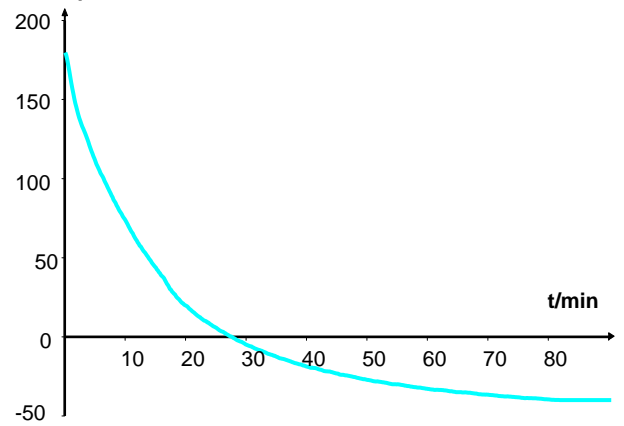

**Heating-up graph MKF 240**

Temp. / °C

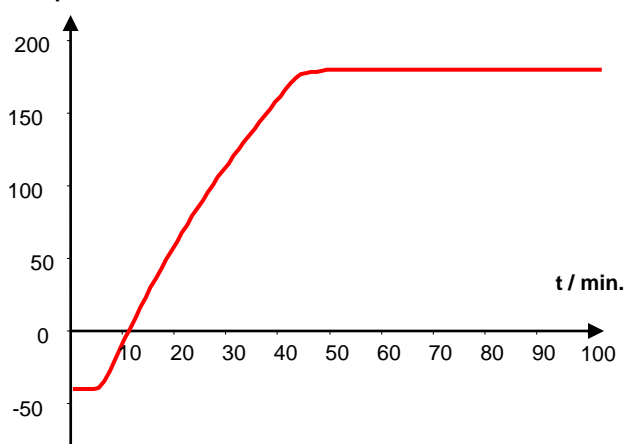

**Cooling-down graph MKF 240**

Temp. / °C

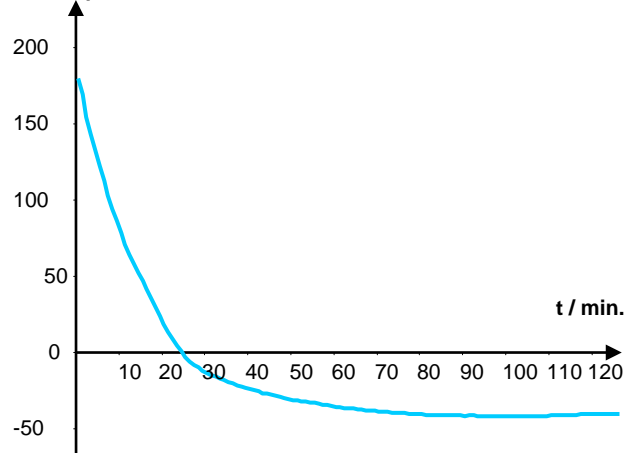

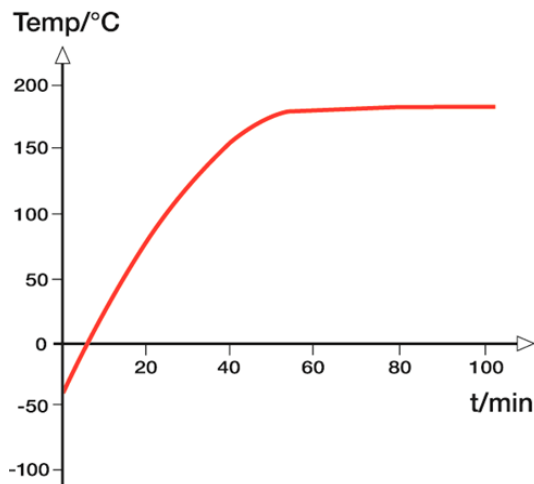
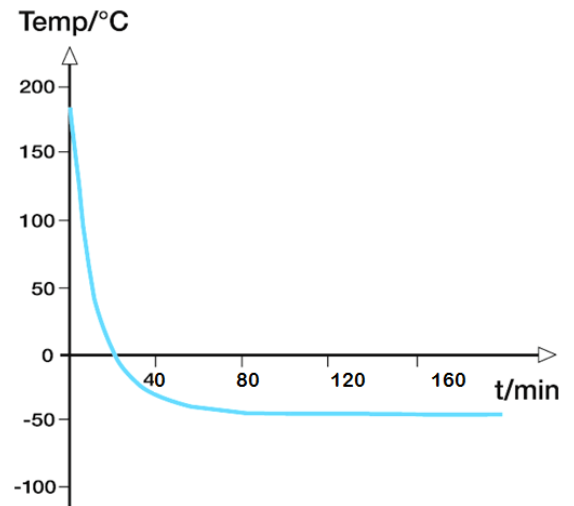
**Heating-up graph MKF 720**

**Cooling-down graph MKF 720**

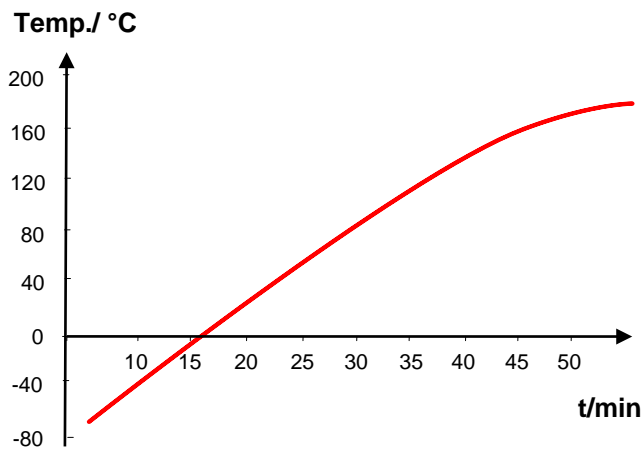
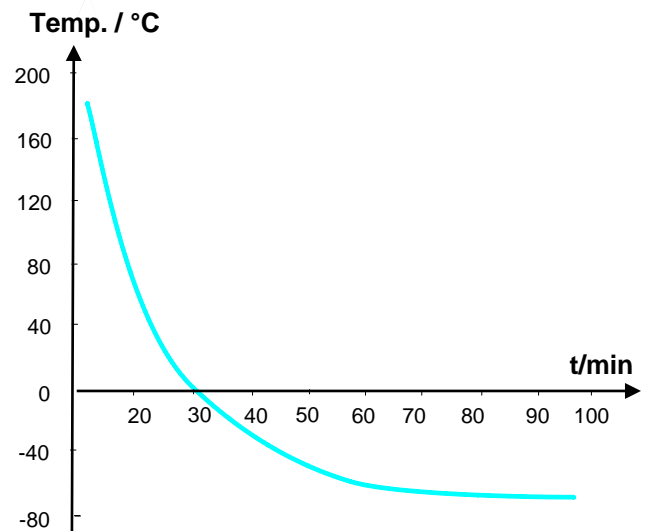
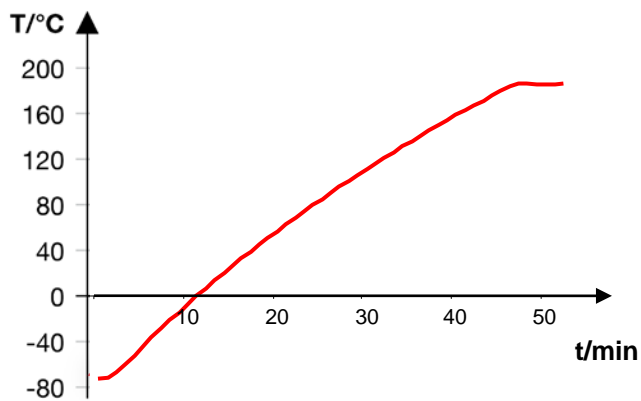
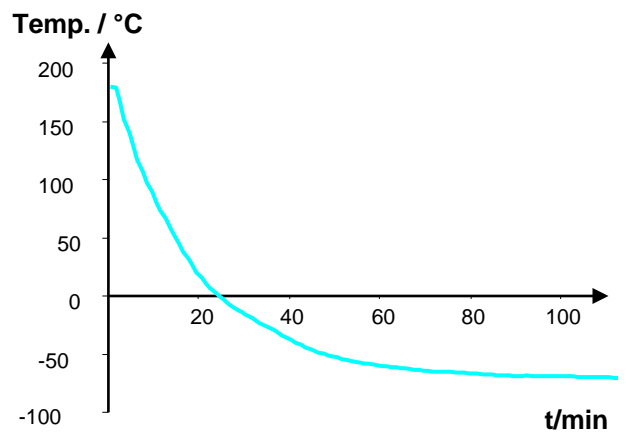
## 25.9 MKFT heating-up and cooling-down graphs

**Heating-up graph MKFT 115**

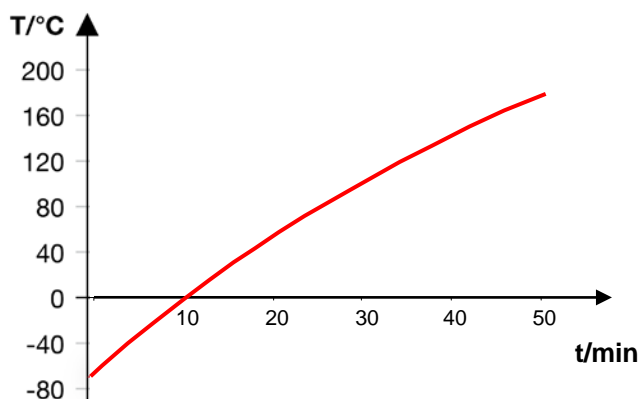
**Cooling-down graph MKFT 115**

**Heating-up graph MKFT 240**

**Cooling-down graph MKFT 240**

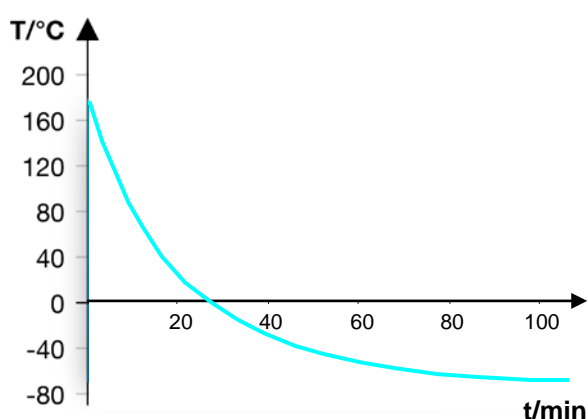
Heating-up graph MKFT 720



Cooling-down graph MKFT 720



### 25.10 MKF heat compensation graphs

MKF 56 heat compensation

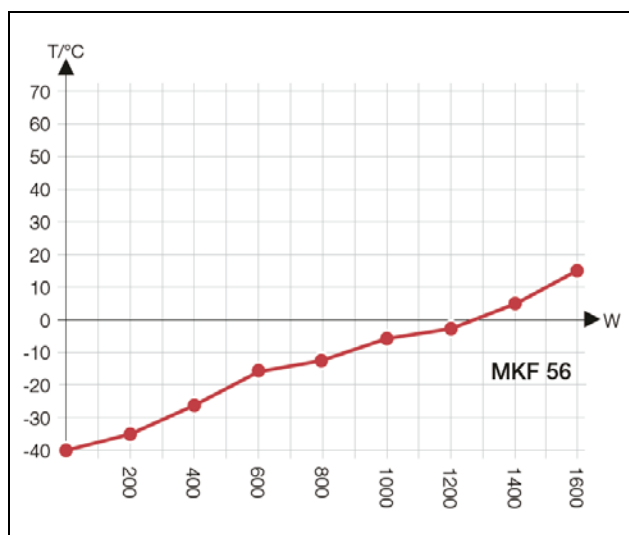

MKF 115 heat compensation

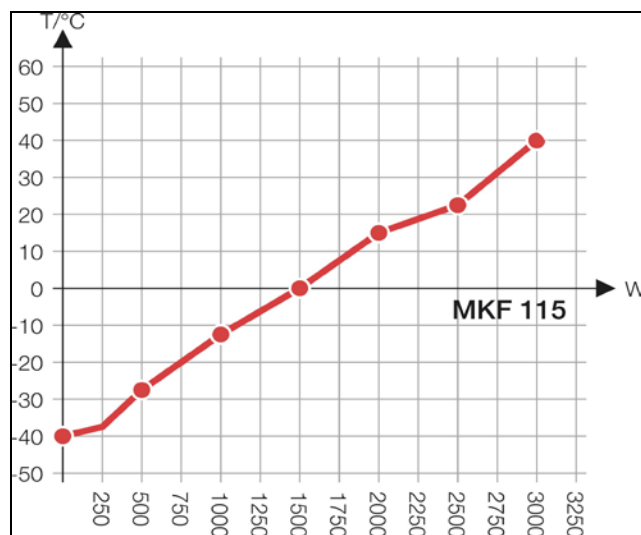

MKF 240 heat compensation

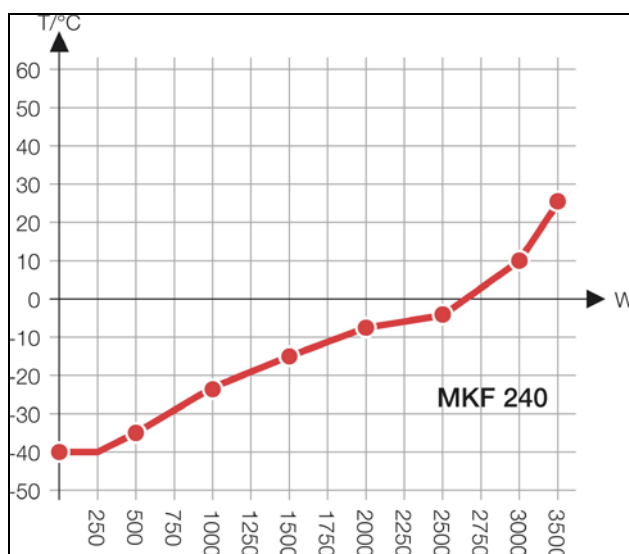

MKF 720 heat compensation

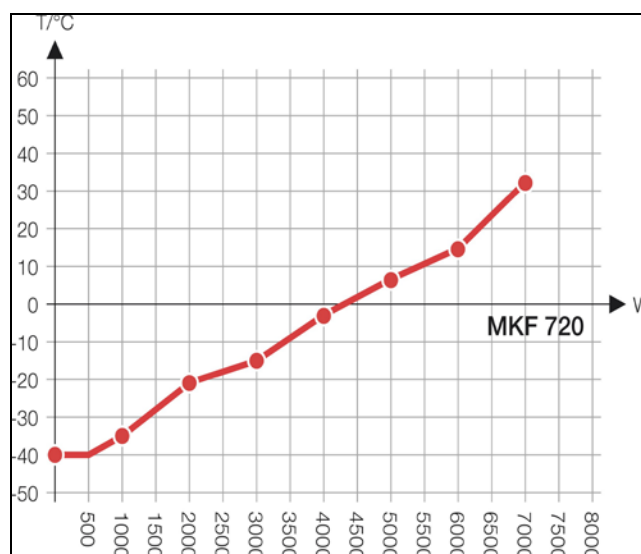



Bringing in a heat load leads to continuous operation of refrigerating machine. In this case frequent maintenance intervals are necessary.

### 25.11 MKFT heat compensation graphs

**MKFT 115 heat compensation**

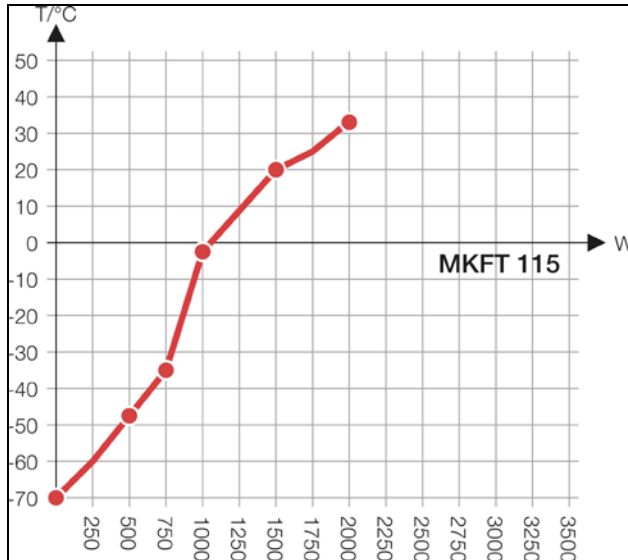

**MKFT 240 heat compensation**

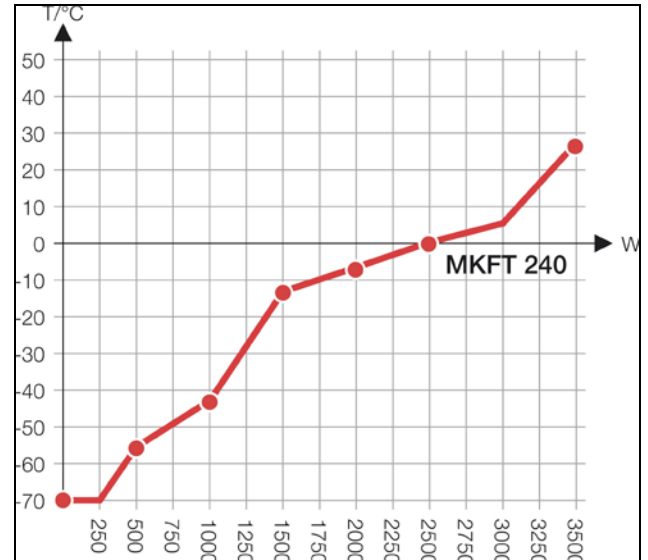

**MKFT 720 heat compensation**

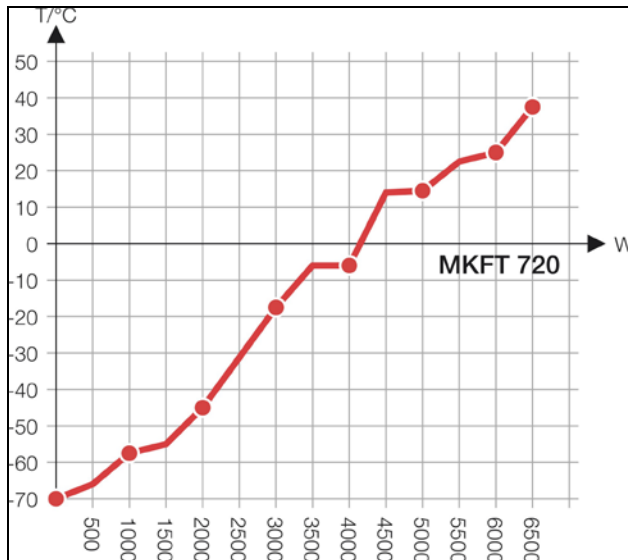

Bringing in a heat load leads to continuous operation of refrigerating machine. In this case frequent maintenance intervals are necessary.

## 25.12 Dimensions

MKF 56 dimensions:

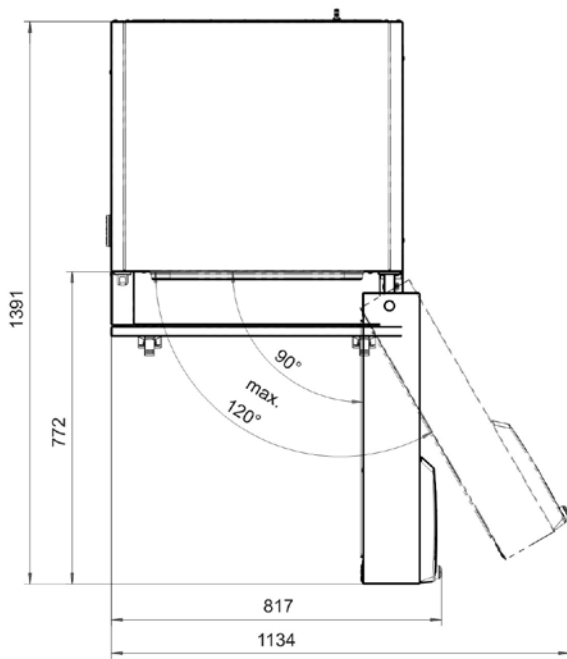
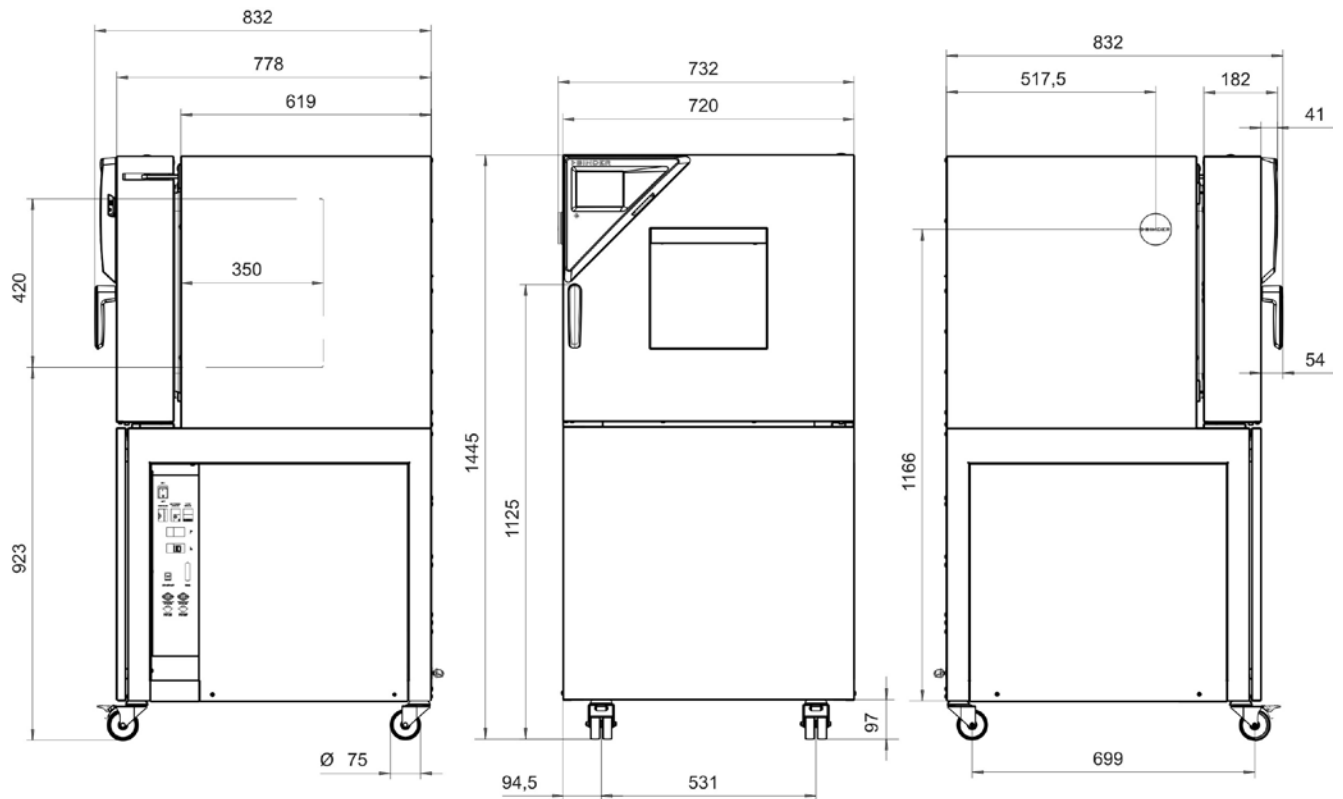

[mm]

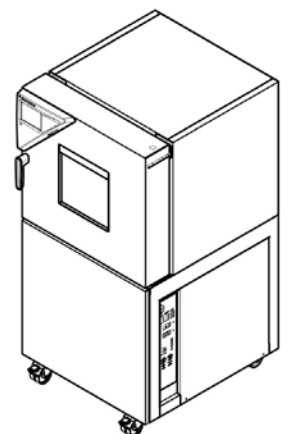
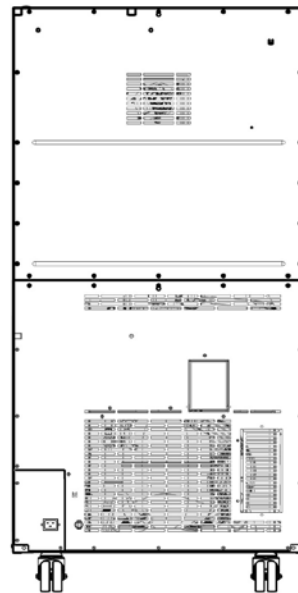

MKF / MKFT 115 dimensions:

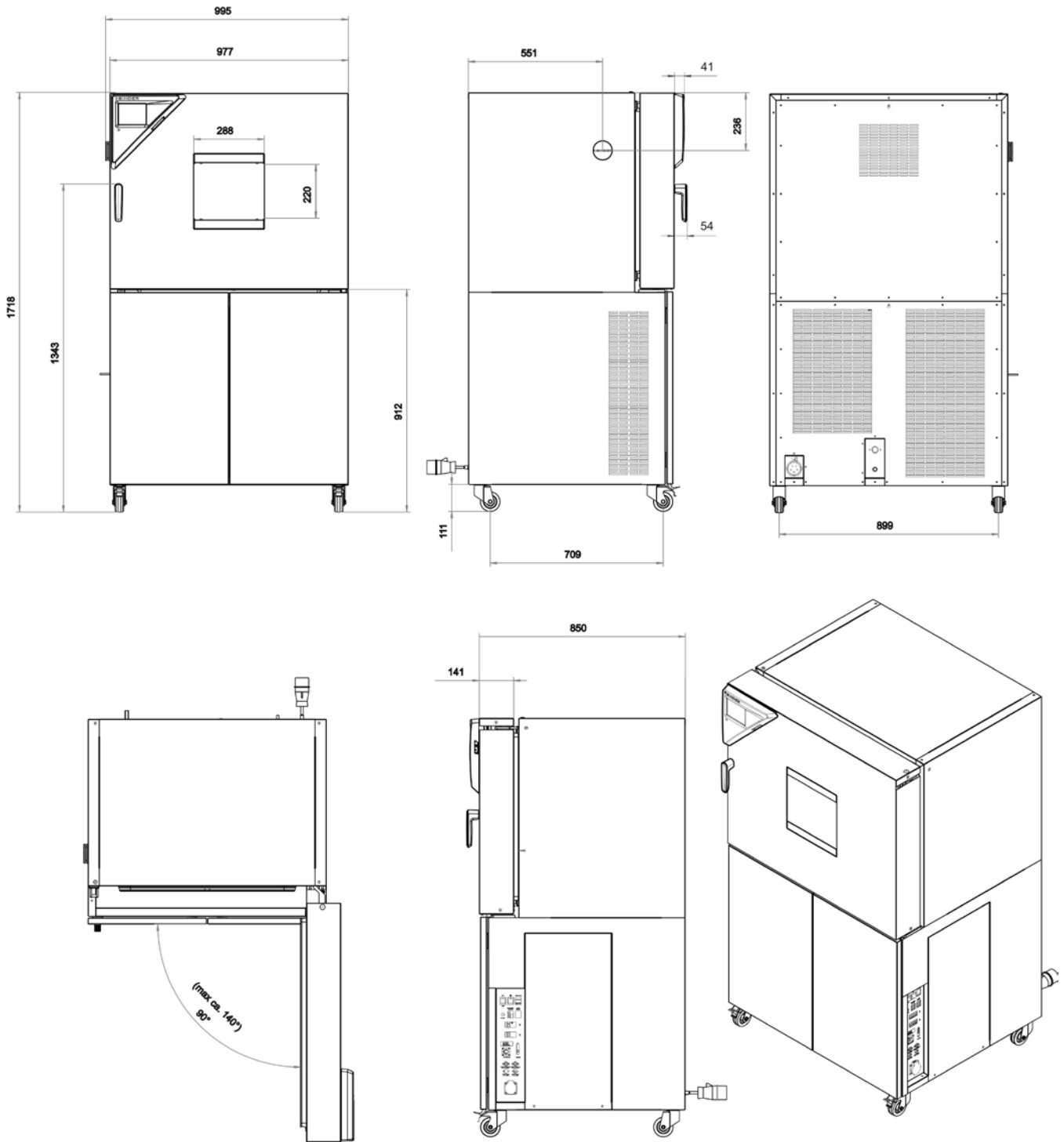

[mm]



MKF 240 dimensions:

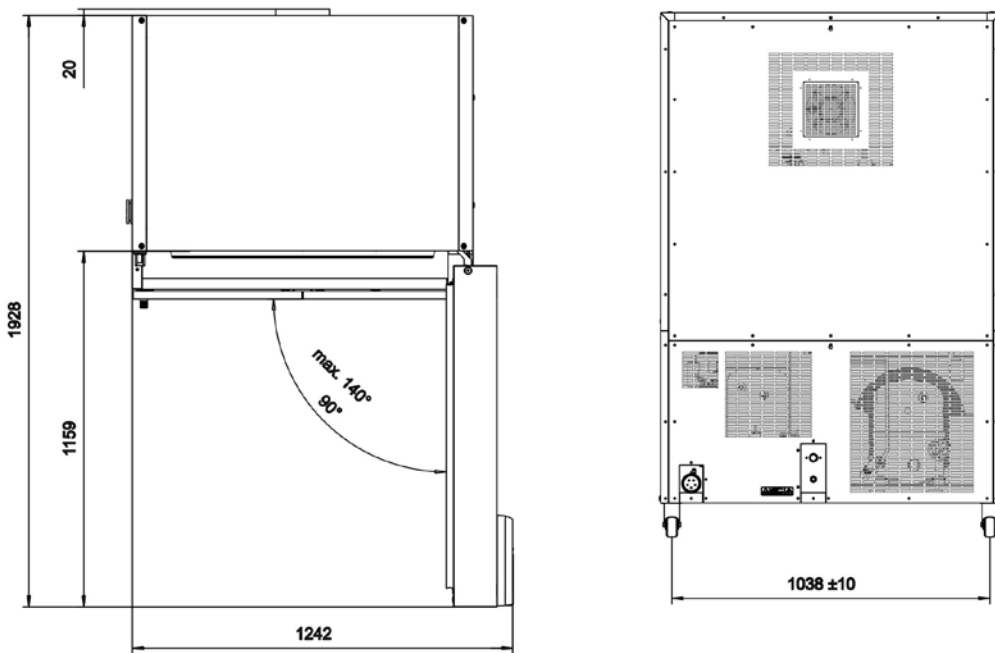
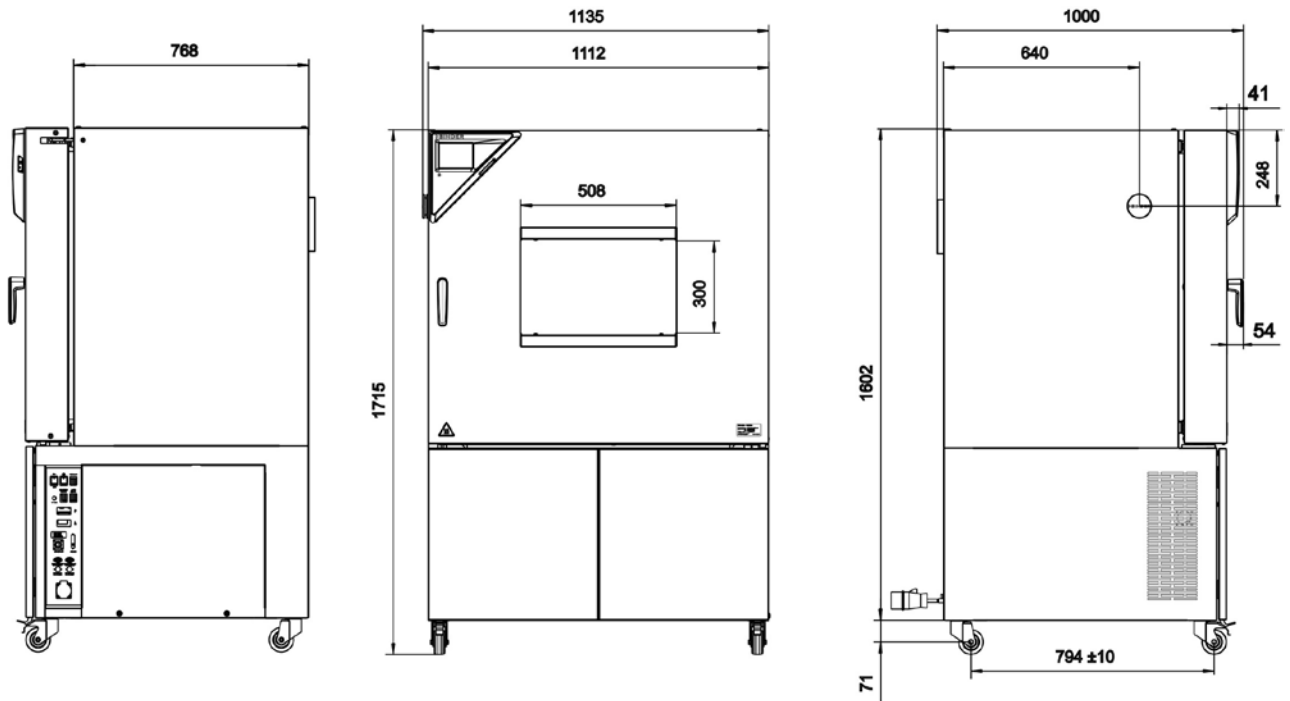

[mm]

**MKFT 240 dimensions:**

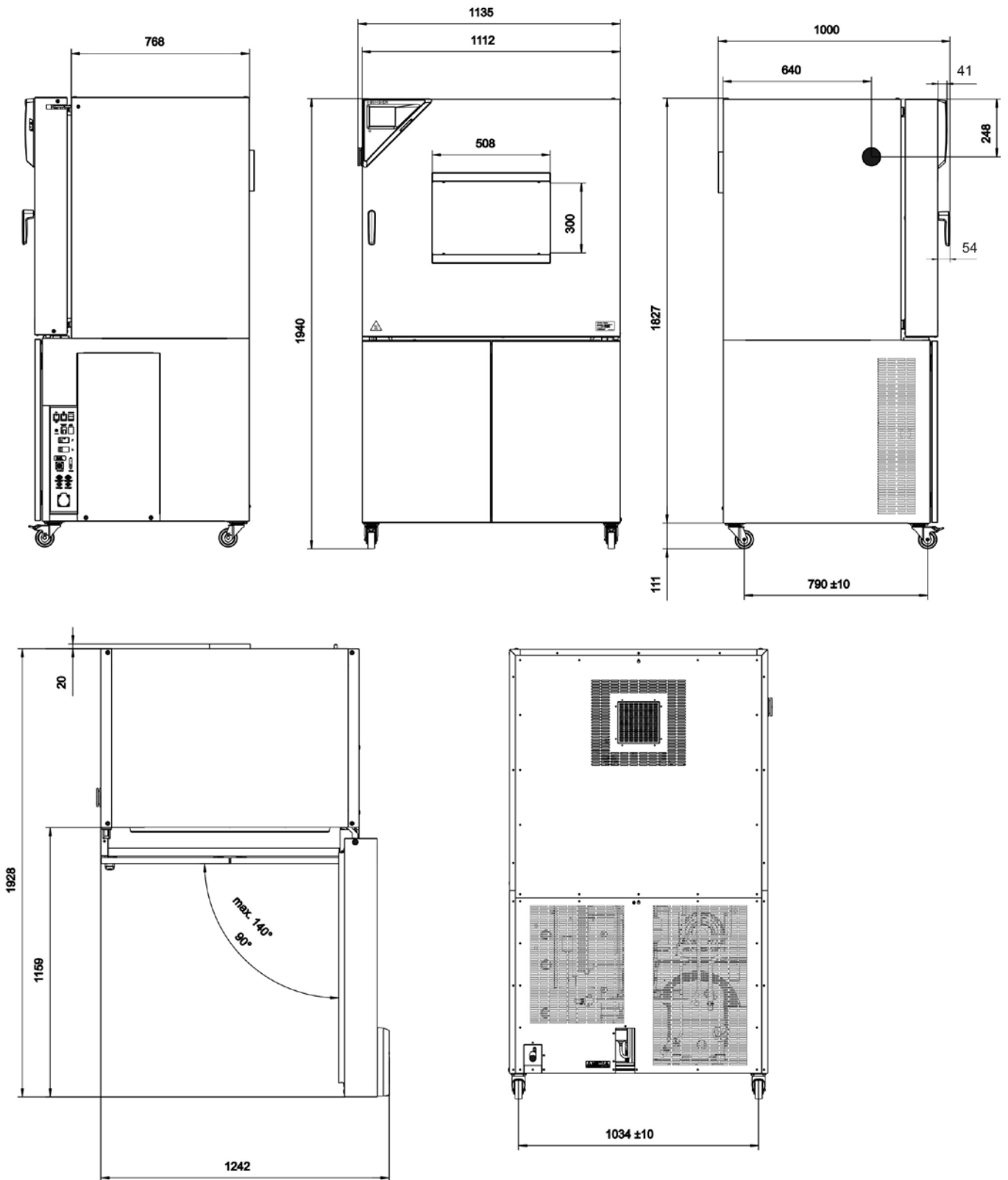

[mm]

MKF / MKFT 720 dimensions:

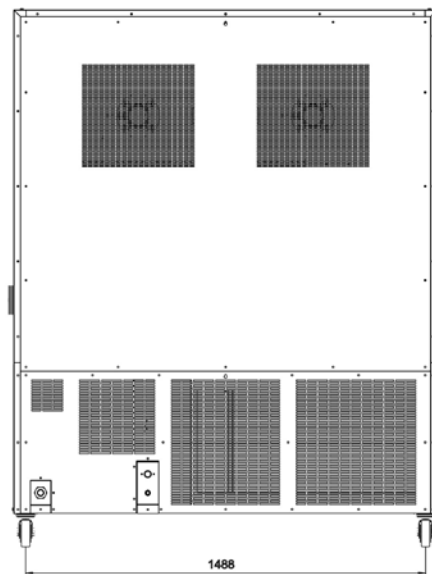
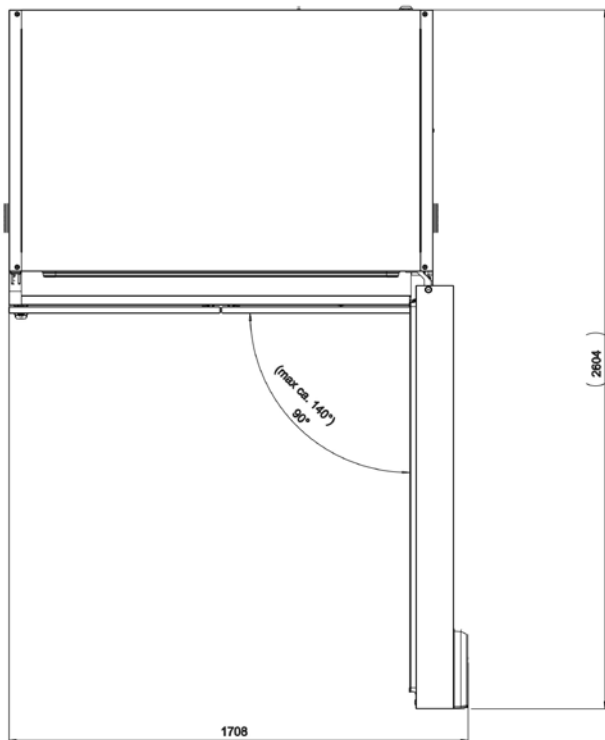
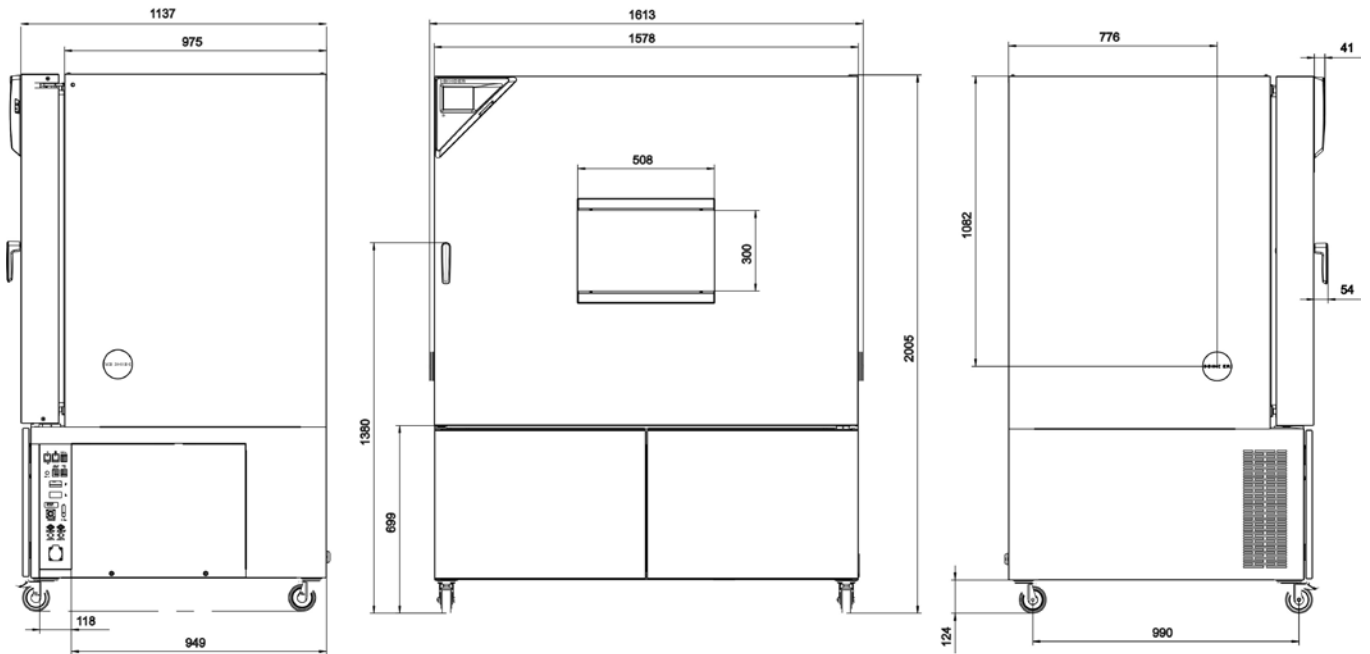

[mm]

## 26. Certificates and declarations of conformity

### 26.1 EU Declaration of Conformity for MKF

  
 Best conditions for your success



**EU-Konformitätserklärung / EU Declaration of Conformity / Déclaration de conformité UE / Declaración de conformidad UE / Dichiarazione di conformità UE / Декларация соответствия EU**

Hersteller / Manufacturer / Fabricant / Fabricante / Fabbricante / Производитель	BINDER GmbH
Anschrift / Address / Adresse / Dirección / Indirizzo / Адрес	Im Mittleren Ösch 5, 78532 Tuttlingen, Germany
Produkt / Product / Produit / Producto / Prodotto / Продукт	Wechselklimaschränke Alternating climate chambers Enceintes climatiques pour des conditions variables Cámaras de clima alternante Camere per condizioni climatiche con alternanza Камеры моделирования условий окружающей среды для сложных температурных условий
Typenbezeichnung / Type / Type / Tipo / Tipo / Тип	MKF 56, MKF 115, MKF 240, MKF 720

Die oben beschriebenen Maschinen sind konform mit folgenden EG/EU-Richtlinien (gemäß Veröffentlichung im Amtsblatt der europäischen Kommission):

The machines described above are in conformity with the following EC/EU Directives (as published in the Official Journal of the European Union):

Les machines décrites ci-dessus sont conformes aux directives CE/UE suivantes (selon leur publication dans le Journal officiel de l'Union européenne):

La máquina descrita arriba cumple con las siguientes directivas de la CE/UE (publicados en el Diario oficial de la Unión Europea):

Le macchine sopra descritte sono conforme alle seguenti direttive CE/UE (secondo la pubblicazione nella Gazzetta ufficiale della Commissione europea):

Машина, указанная выше, полностью соответствует следующим регламентам ЕС/ЕУ (опубликованным в Официальном журнале Европейского Содружества):

- **2006/42/EC**  
Maschinenrichtlinie 2006/42/EG / Machinery directive 2006/42/EC / Directive Machines 2006/42/EC / Directiva 2006/42/CE (Máquinas) / Direttiva macchine 2006/42/CE / Директива о машинах 2006/42/EC
- **2014/30/EU**  
EMV-Richtlinie 2014/30/EU / EMC Directive 2014/30/EU / Directive CEM 2014/30/UE / Directiva CEM 2014/30/UE / Direttiva EMC 2014/30/UE / Директива ЭМС 2014/30/EU
- **2011/65/EU**  
RoHS-Richtlinie 2011/65/EU / RoHS Directive 2011/65/EU / Directive RoHS 2011/65/UE / Directiva RoHS 2011/65/UE / Direttiva RoHS 2011/65/UE / Директива RoHS 2011/65/EU

1 / 3

BINDER GmbH Postfach 102 D-78502 Tuttlingen **Anschrift:** BINDER GmbH Im Mittleren Ösch 5 D-78532 Tuttlingen  
**Kontakt:** Telefon: +49 (0) 74 62 / 20 05 - 0 | Telefax: +49 (0) 74 62 / 20 05 - 100 | info@binder-world.com | www.binder-world.com  
**Geschäftsführung:** Dipl.-Ing. Peter M. Binder | Amtsgericht Stuttgart, HRB 727150 | Sitz der Gesellschaft: Tuttlingen  
**Bankverbindung:** Kreissparkasse Tuttlingen Konto-Nr.: 2266 BLZ: 643 500 70 | IBAN-Code: DE05643 500700 000002266 | SWIFT-Code: SOLA DE S1TUT  
**S-Account** 2202 611 55 | IBAN-Code: DE7464350070 0220 261155 | SWIFT-Code: SOLA DE S1TUT  
**Deutsche Bank Tuttlingen** Konto-Nr.: 2 138 709 BLZ: 653 700 75 | IBAN-Code: DE56653 70075 0213870900 | SWIFT-Code: DEUT DE SS603  
 Altgeräte-Entsorgung gemäß WEEE-Reg.-Nr. DE 37004983

Die oben beschriebenen Maschinen entsprechen aufgrund ihrer Konzipierung und Bauart sowie in der von uns in Verkehr gebrachten Ausführung den einschlägigen grundlegenden Sicherheits- und Gesundheitsanforderungen der genannten EG/EU-Richtlinien.

The machines described above are conform to the mentioned EC/EU directives in regard to the relevant safety and health demands due to their conception and style of construction as well as to the version put onto market by us.

Les machines décrites ci-dessus correspondent aux demandes de sécurité et de santé des directives citées de la CE/UE due à leur conception et construction et dans la réalisation mise sur le marché par nous.

Las máquinas descritas arriba se corresponden con los requisitos básicos pertinentes de seguridad y salud de las citadas directivas de la CE/UE debido a su concepción y fabricación, así como a la realización llevada a cabo por nosotros.

Le macchine sopra descritte sono conforme ai requisiti essenziali di sanità e sicurezza pertinenti delle summenzionate direttive CE/UE in termini di progettazione, tipo di costruzione ed esecuzione messa da noi in circolazione.

Машины описано выше, соответствует указанным директивам ЕС/ЕУ в отношении требований соответствующей безопасности и здоровья по концепции и конструкции так же как и версия, применяемая нами на рынке.

Die oben beschriebenen Maschinen tragen entsprechend die Kennzeichnung CE.

The machines described above, corresponding to this, bear the CE-mark.

Les machines décrits ci-dessus, en correspondance, portent l'indication CE.

Las máquinas descritas arriba, en conformidad, llevan la indicación CE.

Le macchine sopra descritte sono contrassegnate dal marchio CE.

Машины описано выше, в соответствии с изложенным выше маркированы знаком CE.

Die oben beschriebenen Maschinen sind konform mit folgenden harmonisierten Normen:

The machines described above are in conformity with the following harmonized standards:

Les machines décrits ci-dessus sont conformes aux normes harmonisées suivantes:

Las máquinas descritas arriba cumplen con las siguientes normas:

Le macchine sopra descritte sono conforme alle seguenti normative armonizzate:

Машины описано выше, полностью соответствуют следующим стандартам:

Sicherheit / Safety / Sécurité / Seguridad / Sicurezza / Нормативы по безопасности
<ul style="list-style-type: none"> <li>• EN ISO 12100:2010 + Corr. 1:2011</li> <li>• EN ISO 13732-1:2008</li> <li>• EN 60204-1:2006 + A1:2009 + Corr. :2010</li> </ul>
EMV / EMC / CEM / CEM / EMC / ЭМС
<ul style="list-style-type: none"> <li>• EN 61326-1:2013</li> </ul>
RoHS
<ul style="list-style-type: none"> <li>• EN 50581:2012</li> </ul>

78532 Tuttlingen, 24.01.2018

BINDER GmbH

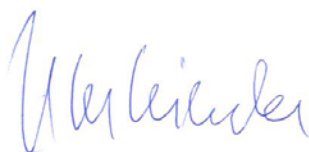

P. M. Binder

Geschäftsführender Gesellschafter  
Managing Director  
Directeur général  
Director general  
Direttore Generale  
Директор



J. Bollaender

Leiter F & E und Dokumentationsbevollmächtigter  
Director R & D and documentation representative  
Chef de service R&D et autorisé de documentation  
Responsable I & D y representante de documentación  
Direttore R & D e responsabile della documentazione  
Глава департамента R&D представитель документации

3 / 3

**BINDER GmbH** Postfach 102 D-78502 Tuttlingen **Anschrift:** BINDER GmbH im Mittleren Ösch 5 D-78532 Tuttlingen  
**Kontakt:** Telefon: +49 (0) 74 62 / 20 05 – 0 | Telefax: +49 (0) 74 62 / 20 05 – 100 | info@binder-world.com | www.binder-world.com  
**Geschäftsführung:** Dipl.-Ing. Peter M. Binder | Amtsgericht Stuttgart, HRB 727150 | Sitz der Gesellschaft: Tuttlingen  
**Bankverbindung:** Kreissparkasse Tuttlingen Konto-Nr.: 2266 BLZ: 643 500 70 | IBAN-Code: DE05643 500700 000002266 | SWIFT-Code: SOLA DE S1TUT  
\$-Account 2202 611 55 | IBAN-Code: DE7464350070 0220 261155 | SWIFT-Code: SOLA DE S1TUT  
Deutsche Bank Tuttlingen Konto-Nr.: 2 138 709 BLZ: 653 700 75 | IBAN-Code: DE56653 70075 0213870900 | SWIFT-Code: DEUT DE SS603  
Altgeräte-Entsorgung gemäß WEEE-Reg.-Nr. DE 37004983



## 26.2 EU Declaration of Conformity for MKFT



**CE** EU-Konformitätserklärung / EU Declaration of Conformity / Déclaration de conformité UE / Declaración de conformidad UE / Dichiarazione di conformità UE / Декларация соответствия EU

Hersteller / Manufacturer / Fabricant / Fabricante / Fabbricante / Производитель	BINDER GmbH
Anschrift / Address / Adresse / Dirección / Indirizzo / Адрес	Im Mittleren Ösch 5, 78532 Tuttlingen, Germany
Produkt / Product / Produit / Producto / Prodotto / Продукт	Wechselklimaschränke mit Tieftemperatur Alternating climate chambers with deep temperature Enceintes climatiques pour des conditions variables à basses températures Cámaras de clima alternante con zona de baja temperatura Camere per condizioni climatiche con alternanza, con zona di temperatura bassa Камеры моделирования условий окружающей среды для сложных условий в области низких температур
Typenbezeichnung / Type / Type / Tipo / Tipo / Тип	MKFT 115, MKFT 240, MKFT 720

Die oben beschriebenen Maschinen sind konform mit folgenden EG/EU-Richtlinien (gemäß Veröffentlichung im Amtsblatt der europäischen Kommission):

The machines described above are in conformity with the following EC/EU Directives (as published in the Official Journal of the European Union):

Les machines décrites ci-dessus sont conformes aux directives CE/UE suivantes (selon leur publication dans le Journal officiel de l'Union européenne):

La máquina descrita arriba cumple con las siguientes directivas de la CE/UE (publicados en el Diario oficial de la Unión Europea):

Le macchine sopra descritte sono conforme alle seguenti direttive CE/UE (secondo la pubblicazione nella Gazzetta ufficiale della Commissione europea):

Машина, указанная выше, полностью соответствует следующим регламентам ЕС/ЕУ (опубликованным в Официальном журнале Европейского Содружества):

- **2006/42/EC**  
Maschinenrichtlinie 2006/42/EG / Machinery directive 2006/42/EC / Directive Machines 2006/42/EC / Directiva 2006/42/CE (Máquinas) / Direttiva macchine 2006/42/CE / Директива о машинах 2006/42/EC
- **2014/30/EU**  
EMV-Richtlinie 2014/30/EU / EMC Directive 2014/30/EU / Directive CEM 2014/30/UE / Directiva CEM 2014/30/UE / Direttiva EMC 2014/30/UE / Директива ЭМС 2014/30/EU
- **2011/65/EU**  
RoHS-Richtlinie 2011/65/EU / RoHS Directive 2011/65/EU / Directive RoHS 2011/65/UE / Directiva RoHS 2011/65/UE / Direttiva RoHS 2011/65/UE / Директива RoHS 2011/65/EU

1 / 3

BINDER GmbH Postfach 102 D-78502 Tuttlingen **Anschrift:** BINDER GmbH Im Mittleren Ösch 5 D-78532 Tuttlingen  
**Kontakt:** Telefon: +49 (0) 74 62 / 20 05 – 0 | Telefax: +49 (0) 74 62 / 20 05 – 100 | info@binder-world.com | www.binder-world.com  
**Geschäftsführung:** Dipl.-Ing. Peter M. Binder | Amtsgericht Stuttgart, HRB 727150 | Sitz der Gesellschaft: Tuttlingen  
**Bankverbindung:** Kreissparkasse Tuttlingen Konto-Nr.: 2266 BLZ: 643 500 70 | IBAN-Code: DE05643 500700 000002266 | SWIFT-Code: SOLA DE S1TUT  
 \$-Account 2202 611 55 | IBAN-Code: DE7464350070 0220 261155 | SWIFT-Code: SOLA DE S1TUT  
 Deutsche Bank Tuttlingen Konto-Nr.: 2 138 709 BLZ: 653 700 75 | IBAN-Code: DE56653 70075 0213870900 | SWIFT-Code: DEUT DE SS603  
 Altgeräte-Entsorgung gemäß WEEE-Reg.-Nr. DE 37004983

Die oben beschriebenen Maschinen entsprechen aufgrund ihrer Konzipierung und Bauart sowie in der von uns in Verkehr gebrachten Ausführung den einschlägigen grundlegenden Sicherheits- und Gesundheitsanforderungen der genannten EG/EU-Richtlinien.

The machines described above are conform to the mentioned EC/EU directives in regard to the relevant safety and health demands due to their conception and style of construction as well as to the version put onto market by us.

Les machines décrites ci-dessus correspondent aux demandes de sécurité et de santé des directives citées de la CE/UE due à leur conception et construction et dans la réalisation mise sur le marché par nous.

Las máquinas descritas arriba se corresponden con los requisitos básicos pertinentes de seguridad y salud de las citadas directivas de la CE/UE debido a su concepción y fabricación, así como a la realización llevada a cabo por nosotros.

Le macchine sopra descritte sono conforme ai requisiti essenziali di sanità e sicurezza pertinenti delle summenzionate direttive CE/UE in termini di progettazione, tipo di costruzione ed esecuzione messa da noi in circolazione.

Машины описано выше, соответствует указанным директивам ЕС/ЕУ в отношении требований соответствующей безопасности и здоровья по концепции и конструкции так же как и версия, применяемая нами на рынке.

Die oben beschriebenen Maschinen tragen entsprechend die Kennzeichnung CE.

The machines described above, corresponding to this, bear the CE-mark.

Les machines décrits ci-dessus, en correspondance, portent l'indication CE.

Las máquinas descritas arriba, en conformidad, llevan la indicación CE.

Le macchine sopra descritte sono contrassegnate dal marchio CE.

Машины описано выше, в соответствии с изложенным выше маркированы знаком CE.

Die oben beschriebenen Maschinen sind konform mit folgenden harmonisierten Normen:

The machines described above are in conformity with the following harmonized standards:

Les machines décrits ci-dessus sont conformes aux normes harmonisées suivantes:

Las máquinas descritas arriba cumplen con las siguientes normas:

Le macchine sopra descritte sono conforme alle seguenti normative armonizzate:

Машины описано выше, полностью соответствуют следующим стандартам:

Sicherheit / Safety / Sécurité / Seguridad / Sicurezza / Нормативы по безопасности
<ul style="list-style-type: none"> <li>• EN ISO 12100:2010 + Corr. 1:2011</li> <li>• EN ISO 13732-1:2008</li> <li>• EN 60204-1:2006 + A1:2009 + Corr. :2010</li> </ul>
EMV / EMC / CEM / CEM / EMC / ЭМС
<ul style="list-style-type: none"> <li>• EN 61326-1:2013</li> </ul>
RoHS
<ul style="list-style-type: none"> <li>• EN 50581:2012</li> </ul>

2 / 3

**BINDER GmbH** Postfach 102 D-78502 Tuttlingen **Anschrift:** BINDER GmbH Im Mittleren Ösch 5 D-78532 Tuttlingen  
**Kontakt:** Telefon: +49 (0) 74 62 / 20 05 – 0 | Telefax: +49 (0) 74 62 / 20 05 – 100 | info@binder-world.com | www.binder-world.com  
**Geschäftsführung:** Dipl.-Ing. Peter M. Binder | Amtsgericht Stuttgart, HRB 727150 | Sitz der Gesellschaft: Tuttlingen  
**Bankverbindung:** Kreissparkasse Tuttlingen Konto-Nr.: 2266 BLZ: 643 500 70 | IBAN-Code: DE05643 500700 000002266 | SWIFT-Code: SOLA DE S1TUT  
**\$-Account** 2202 611 55 | IBAN-Code: DE7464350070 0220 261155 | SWIFT-Code: SOLA DE S1TUT  
**Deutsche Bank Tuttlingen** Konto-Nr.: 2 138 709 BLZ: 653 700 75 | IBAN-Code: DE56653 70075 0213870900 | SWIFT-Code: DEUT DE 55603  
 Altgeräte-Entsorgung gemäß WEEE-Reg.-Nr. DE 37004983



78532 Tuttlingen, 24.01.2018

BINDER GmbH



P. M. Binder

Geschäftsführender Gesellschafter

Managing Director

Directeur général

Director general

Direttore Generale

Директор



J. Bollaender

Leiter F & E und Dokumentationsbevollmächtigter

Director R & D and documentation representative

Chef de service R&D et autorisé de documentation

Responsable I & D y representante de documentación

Direttore R & D e responsabile della documentazione

Глава департамента R&D представитель документации

3 / 3

**BINDER GmbH** Postfach 102 D-78502 Tuttlingen **Anschrift:** BINDER GmbH Im Mittleren Ösch 5 D-78532 Tuttlingen  
**Kontakt:** Telefon: +49 (0) 74 62 / 20 05 – 0 | Telefax: +49 (0) 74 62 / 20 05 – 100 | info@binder-world.com | www.binder-world.com  
**Geschäftsführung:** Dipl.-Ing. Peter M. Binder | Amtsgericht Stuttgart, HRB 727150 | Sitz der Gesellschaft: Tuttlingen  
**Bankverbindung:** Kreissparkasse Tuttlingen Konto-Nr.: 2266 BLZ: 643 500 70 | IBAN-Code: DE05643 500700 000002266 | SWIFT-Code: SOLA DE S1TUT  
\$-Account 2202 611 55 | IBAN-Code: DE7464350070 0220 261155 | SWIFT-Code: SOLA DE S1TUT  
Deutsche Bank Tuttlingen Konto-Nr.: 2 138 709 BLZ: 653 700 75 | IBAN-Code: DE56653 70075 0213870900 | SWIFT-Code: DEUT DE SS603  
Altgeräte-Entsorgung gemäß WEEE-Reg.-Nr. DE 37004983

## 26.3 Certificate for the GS mark of conformity of the "Deutsche Gesetzliche Unfallversicherung e.V." (German Social Accident Insurance) DGUV

Zertifikat  
Nr. **NV 16171**  
vom 17.06.2016

 **DGUV Test**  
Prüf- und Zertifizierungsstelle  
Nahrungsmittel und Verpackung  
Fachbereich Nahrungsmittel

### GS-Zertifikat

Name und Anschrift des Zertifikatsinhabers: (Auftraggeber)	<b>Binder GmbH</b> Im Mittleren Ösch 5 78532 Tuttlingen
Produktbezeichnung:	<b>Klimaschränke      Umweltsimulationsschrank</b>
Typ:	MK 56, MK 115, MK 240, MK 720, MKF 56, MKF 115, MKF 240, MKF 720, MKT 115, MKT 240, MKT 720, MKFT 115, MKFT 240, MKFT 720
Prüfgrundlage:	GS-NV 5:2015/12 Prüfgrundsätze für Kühl- und Gefriermaschinen für Industrie und Gewerbe
Zugehöriger Prüfbericht:	Prüfbericht zum Zertifikat NV 16171
Weitere Angaben:	Das Zertifikat bezieht sich auf die im zugehörigen Prüfbericht beschriebene Ausführung des Produkts. Ersatz für NV 14136.

Das geprüfte Baumuster stimmt mit den in § 21 Absatz 1 des Produktsicherheitsgesetzes genannten Anforderungen überein. Der Bescheinigungsinhaber ist berechtigt, das umseitig abgebildete GS-Zeichen an den mit dem geprüften Baumuster übereinstimmenden Produkten anzubringen. Der Bescheinigungsinhaber hat dabei die umseitig aufgeführten Bedingungen zu beachten.

Dieses Zertifikat einschließlich der Berechtigung zur Anbringung des GS-Zeichens ist gültig bis:  
**23.06.2019**

Weiteres über die Gültigkeit, eine Gültigkeitsverlängerung und andere Bedingungen regelt die Prüf- und Zertifizierungsordnung.



PZB04\_D  
11.14

Deutsche Gesetzliche Unfallversicherung (DGUV) e.V.  
Spitzenverband der gewerblichen Berufsgenossenschaften  
und der Unfallversicherungsträger der öffentlichen Hand  
Vereinsregister-Nr. VR 751 B, Amtsgericht Charlottenburg

DGUV Test Prüf- und Zertifizierungsstelle Nahrungsmittel und Verpackung  
Fachbereich Nahrungsmittel  
Dynamostraße 7-11 • 68165 Mannheim • Deutschland  
Telefon: +49 (0) 6 21 44 56-34 30 • Fax: +49 (0) 800 1977 553 16625

Rückseite GS-Zertifikat: NV 16171

### GS-Zeichen



Normalausführung



Bei einer Höhe von 20 mm oder weniger  
auch zulässige Ausführung

1)Zertifikats-Nummer

1. Der Zertifikatsinhaber hat die Voraussetzungen einzuhalten, die bei der Herstellung des umseitig genannten Produktes zu beachten sind, um die Übereinstimmung mit dem geprüften Baumuster zu gewährleisten.
2. Die Prüf- und Zertifizierungsstelle des Fachbereichs Nahrungsmittel führt in regelmäßigen Abständen Kontrollmaßnahmen zur Überwachung der Herstellung und rechtmäßigen Verwendung des GS-Zeichens durch.
3. Die für die Herstellung verantwortliche Person hat sich zur Einhaltung der Voraussetzungen nach Nummer 1 und Duldung der Kontrollmaßnahmen verpflichtet.
4. Die Prüf- und Zertifizierungsstelle entzieht dem Zertifikatsinhaber die Zuerkennung des GS-Zeichens, wenn sich die Anforderungen nach § 21 Absatz 1 Produktsicherheitsgesetz geändert haben oder die Voraussetzungen nach Nummer 1 nicht eingehalten werden.
5. Das GS-Zeichen darf nur verwendet und mit ihm darf nur geworben werden, wenn die Voraussetzungen nach § 22 Produktsicherheitsgesetz erfüllt sind.

## 27. Product registration

# Online Product Registration

Register your BINDER now!

[www.binder-world.com/register](http://www.binder-world.com/register)

The registration is free and takes just a few seconds

Advantages:

- ▶ Short response times if service is needed
- ▶ Fair prices when relocating or installing equipment
- ▶ Calibration as required at no charge in case of recalls
- ▶ Free information on news, product upgrades and accessories

Easy registered in 3 steps:



1. List serial number here:

-

2. Go online: [www.binder-world.com/register](http://www.binder-world.com/register)

3. Register serial number

## 28. Contamination clearance certificate

### 28.1 For chambers located outside the USA and Canada

#### Declaration regarding safety and health

Erklärung zur Sicherheit und gesundheitlichen Unbedenklichkeit

The German Ordinance on Hazardous Substances (GefStofV), and the regulations regarding safety at the workplace, require that this form be filled out for all products that are returned to us, so that the safety and the health of our employees can be guaranteed.

Die Sicherheit und Gesundheit unserer Mitarbeiter, die Gefahrstoffverordnung GefStofV und die Vorschriften zur Sicherheit am Arbeitsplatz machen es erforderlich, dass dieses Formblatt für alle Produkte, die an uns zurückgeschickt wird.

	<p>Note: A repair is not possible without a completely filled out form. Ohne Vorliegen des vollständig ausgefüllten Formblattes ist eine Reparatur nicht möglich.</p>
---	---

- A completely filled out form must be transmitted via Fax (+49 (0) 7462 2005 93555) or by letter in advance, so that this information is available before the equipment/component part arrives. A second copy of this form must accompany the equipment/component part. In addition, the carrier should be informed.

Eine vollständig ausgefüllte Kopie dieses Formblattes soll per Telefax (Nr. +49 (0) 7462 2005 93555) oder Brief vorab an uns gesandt werden, so dass die Information vorliegt, bevor das Gerät/Bauteil eintrifft. Eine weitere Kopie soll dem Gerät/Bauteil beigelegt sein. Ggf. ist auch die Spedition zu informieren.

- Incomplete information or non-conformity with this procedure will inevitably lead to substantial delays in processing. Please understand the reason for this measure, which lies outside our area of influence and will help us to speed up this procedure.

Unvollständige Angaben oder Nichteinhalten dieses Ablaufs führen zwangsläufig zu beträchtlichen Verzögerungen in der Abwicklung. Bitte haben Sie Verständnis für Maßnahmen, die außerhalb unserer Einflussmöglichkeiten liegen und helfen Sie mit, den Ablauf beschleunigen.

- **Please print and fill out this form completely.**

Bitte unbedingt vollständig ausfüllen!

<b>1.</b>	<b>Unit/ component part / type: / Gerät / Bauteil / Typ:</b>
<b>2.</b>	<b>Serial No./ Serien-Nr.:</b>
<b>3.</b>	<b>Details about utilized substances / biological substances / Einzelheiten über die eingesetzten Substanzen/biologische Materialien:</b>
<b>3.1</b>	<b>Designations / Bezeichnungen:</b>
a)	_____
b)	_____
c)	_____
<b>3.2</b>	<b>Safety measures required for handling these substances / Vorsichtsmaßnahmen beim Umgang mit diesen Stoffen:</b>
a)	_____
b)	_____
c)	_____

<b>3.3</b>	<b>Measures to be taken in case of skin contact or release into the atmosphere / Maßnahmen bei Personenkontakt oder Freisetzung:</b>
a)	_____
b)	_____
c)	_____
d)	_____
<b>3.4</b>	<b>Other important information that must be taken into account / Weitere zu beachtende und wichtige Informationen:</b>
a)	_____
b)	_____
c)	_____
<b>4.</b>	<b>Declaration on the risk of these substances (please checkmark the applicable items) / Erklärung zur Gefährlichkeit der Stoffe (bitte Zutreffendes ankreuzen) :</b>
<input type="checkbox"/>	<b>4.1 For non toxic, non radioactive, biologically harmless materials / für nicht giftige, nicht radioaktive, biologisch ungefährliche Stoffe:</b>
	<b>We hereby guarantee that the above-mentioned unit / component part... / Wir versichern, dass o.g. Gerät/Bauteil...</b>
<input type="checkbox"/>	Has not been exposed to or contains any toxic or otherwise hazardous substances / weder giftige noch sonstige gefährliche Stoffe enthält oder solche anhaften.
<input type="checkbox"/>	That eventually generated reaction products are non-toxic and also do not represent a hazard / auch evtl. entstandene Reaktionsprodukte weder giftig sind noch sonst eine Gefährdung darstellen.
<input type="checkbox"/>	Eventual residues of hazardous substances have been removed / evtl. Rückstände von Gefahrstoffen entfernt wurden.
<input type="checkbox"/>	<b>4.2 For toxic, radioactive, biologically harmful or hazardous substances, or any other hazardous materials / für giftige, radioaktive, biologisch bedenkliche bzw. gefährliche Stoffe oder anderweitig gefährliche Stoffe.</b>
	<b>We hereby guarantee that ... / Wir versichern, dass ...</b>
<input type="checkbox"/>	The hazardous substances, which have come into contact with the above-mentioned equipment/component part, have been completely listed under item 3.1 and that all information in this regard is complete / die gefährlichen Stoffe, die mit dem o.g. Gerät/Bauteil in Kontakt kamen, in 3.1 aufgelistet sind und alle Angaben vollständig sind.
<input type="checkbox"/>	That the unit /component part has not been in contact with radioactivity / das Gerät/Bauteil nicht mit Radioaktivität in Berührung kam
<b>5.</b>	<b>Kind of transport / transporter / Transportweg/Spediteur:</b>
	Transport by (means and name of transport company, etc.) / Versendung durch (Name Spediteur o.ä.)
	_____
	Date of dispatch to BINDER GmbH / Tag der Absendung an BINDER GmbH:
	_____

**We hereby declare that the following measures have been taken / Wir erklären, dass folgende Maßnahmen getroffen wurden:**

- Hazardous substances were removed from the unit including component parts, so that no hazard exists for any person in the handling or repair of these items / das Gerät/Bauteil wurde von Gefahrstoffen befreit, so dass bei Handhabung/Reparaturen für die betreffenden Person keinerlei Gefährdung besteht
- The unit was securely packaged and properly identified / das Gerät wurde sicher verpackt und vollständig gekennzeichnet.
- Information about the hazardousness of the shipment (if required) has been provided to the transporter / der Spediteur wurde (falls vorgeschrieben) über die Gefährlichkeit der Sendung informiert.

We hereby commit ourselves and guarantee that we will indemnify BINDER GmbH for all damages that are a consequence of incomplete or incorrect information provided by us, and that we will exempt BINDER GmbH from eventual damage claims by third parties./ Wir versichern, dass wir gegenüber BINDER für jeden Schaden, der durch unvollständige und unrichtige Angaben entsteht, haften und BINDER gegen eventuell entstehende Schadensansprüche Dritter freistellen.

We are aware that, in accordance with Article 823 of the German Civil Code (BGB), we are directly liable with regard to third parties, in this instance especially the employees of BINDER GmbH, who have been entrusted with the handling / repair of the unit / component. / Es ist uns bekannt, dass wir gegenüber Dritten – hier insbesondere mit der Handhabung/Reparatur des Geräts/des Bauteils betraute Mitarbeiter der Firma BINDER - gemäß §823 BGB direkt haften

Name: \_\_\_\_\_

Position/Title: \_\_\_\_\_

Date / Datum: \_\_\_\_\_

Signature / Unterschrift: \_\_\_\_\_

Company stamp / Firmenstempel:



Equipment that is returned to the factory for repair must be accompanied by a completely filled out contamination clearance certificate. For service and maintenance on site, such a contamination clearance certificate must be submitted to the service technician before the start of any work. No repair or maintenance of the equipment is possible, without a properly filled out contamination clearance certificate.



## 28.2 For chambers located in the USA and Canada

### Product Return Authorization Request

Please complete this form and the Customer Decontamination Declaration (next 2 pages) and attach the required pictures. E-mail to: IDL\_SalesOrderProcessing\_USA@binder-world.com

After we have received and reviewed the complete information we will decide on the issue of a RMA number. Please be aware that size specifications, voltage specifications as well as performance specifications are available on the internet at [www.binder-world.us](http://www.binder-world.us) at any time.

Take notice of shipping laws and regulations.

	Please fill:	
Reason for return request	<input type="radio"/> Duplicate order	
	<input type="radio"/> Duplicate shipment	
	<input type="radio"/> Demo	<i>Page one completed by sales</i>
	<input type="radio"/> Power Plug / Voltage	115V / 230 V / 208 V / 240V
	<input type="radio"/> Size does not fit space	
	<input type="radio"/> Transport Damage	Shock watch tripped? ( <i>pictures</i> )
	<input type="radio"/> Other (specify below)	
	_____	
Is there a replacement PO?	<input type="radio"/> Yes <input type="radio"/> No	
	<i>If yes -&gt; PO #</i>	
	<i>If yes -&gt; Date PO placed</i>	
Purchase order number		
BINDER model number		
BINDER serial number		
Date unit was received		
Was the unit unboxed?	<input type="radio"/> Yes <input type="radio"/> No	
Was the unit plugged in?	<input type="radio"/> Yes <input type="radio"/> No	
Was the unit in operation?	<input type="radio"/> Yes <input type="radio"/> No	
<i>Pictures of unit attached?</i>	<input type="radio"/> Yes <input type="radio"/> No	Pictures have to be attached!
<i>Pictures of Packaging attached?</i>	<input type="radio"/> Yes <input type="radio"/> No	

	Customer Contact Information	Distributor Contact Information
Name		
Company		
Address		
Phone		
E-mail		



## Customer (End User) Decontamination Declaration

### Health and Hazard Safety declaration

To protect the health of our employees and the safety at the workplace, we require that this form is completed by the user for all products and parts that are returned to us. (Distributors or Service Organizations cannot sign this form)

	<p>NO RMA number will be issued without a completed form. Products or parts returned to our NY warehouse without a RMA number will be refused at the dock.</p>
---	--

A second copy of the completed form must be attached to the outside of the shipping box.

<b>1.</b>	<b>Unit/ component part / type:</b>
<b>2.</b>	<b>Serial No.</b>
<b>3.</b>	<b>List any exposure to hazardous liquids, gasses or substances and radioactive material</b>
<b>3.1</b>	<b>List with MSDS sheets attached where available or needed (if there is not enough space available below, please attach a page):</b>
a)	_____
b)	_____
c)	_____
<b>3.2</b>	<b>Safety measures required for handling the list under 3.1</b>
a)	_____
b)	_____
c)	_____
<b>3.3</b>	<b>Measures to be taken in case of skin contact or release into the atmosphere:</b>
a)	_____
b)	_____
c)	_____
d)	_____
<b>3.4</b>	<b>Other important information that must be considered:</b>
a)	_____
b)	_____
c)	_____

**4. Declaration of Decontamination**

**For toxic, radioactive, biologically and chemically harmful or hazardous substances, or any other hazardous materials.**

**We hereby guarantee that**

- 4.1 Any hazardous substances, which have come into contact with the above-mentioned equipment / component part, have been completely listed under item 3.1 and that all information in this regard is complete.
- 4.2 That the unit /component part has not been in contact with radioactivity
- 4.3 Any Hazardous substances were removed from the unit / component part, so that no hazard exists for a persons in the shipping, handling or repair of these returned unit
- 4.4 The unit was securely packaged in the original undamaged packaging and properly identified on the outside of the packaging material with the unit designation, the RMA number and a copy of this declaration.
- 4.5 Shipping laws and regulations have not been violated.

**I hereby commit and guarantee that we will indemnify BINDER Inc. for all damages that are a consequence of incomplete or incorrect information provided by us, and that we will indemnify and hold harmless BINDER Inc. from eventual damage claims by third parties.**

Name: \_\_\_\_\_

Position: \_\_\_\_\_

Company: \_\_\_\_\_

Address: \_\_\_\_\_

Phone #: \_\_\_\_\_

Email: \_\_\_\_\_

Date: \_\_\_\_\_

Signature: \_\_\_\_\_



Equipment returned to the NY warehouse for repair must be accompanied by a completed customer decontamination declaration. For service and maintenance works on site, such a customer decontamination declaration must be submitted to the service technician before the start of work. No repair or maintenance of the equipment is possible without a completed form.

