

HI5221 & HI5222

pH/mV/ISE/Temperature
Bench Meters



INSTRUCTION MANUAL

Dear Customer

Thank you for choosing a Hanna Instruments product.

Please read this instruction manual carefully before using this instrument. This manual will provide you with the necessary information for correct use of this instrument, as well as a precise idea of its versatility.

If you need additional technical information, do not hesitate to e-mail us at tech@hannainst.com or view our worldwide contact list for a Hanna representative near you at www.hannainst.com.

All rights are reserved. Reproduction in whole or in part is prohibited without the written consent of the copyright owner, Hanna Instruments Inc., Woonsocket, Rhode Island, 02895, USA.

PRELIMINARY EXAMINATION	4
GENERAL DESCRIPTION	5
FUNCTIONAL DESCRIPTION	6
SPECIFICATIONS	9
OPERATIONAL GUIDE	10
DISPLAYING MODES.....	11
SYSTEM SETUP	15
pH SETUP	21
mV SETUP	35
ISE SETUP (HI5222 only)	37
pH CALIBRATION	45
pH MEASUREMENT	49
mV & Relative mV MEASUREMENTS	51
ISE CALIBRATION (HI5222 only)	53
ISE MEASUREMENT (HI5222 only)	56
TEMPERATURE CALIBRATION	63
LOGGING	64
PC INTERFACE	68
ADDITIONAL INFORMATION	69
pH BUFFER TEMPERATURE DEPENDENCE	72
ELECTRODE CONDITIONING AND MAINTENANCE	73
TROUBLESHOOTING GUIDE	75
TEMPERATURE CORRELATION FOR pH SENSITIVE GLASS	76
ACCESSORIES	77

Remove the instrument from the packing material and examine it carefully to make sure that no damage has occurred during shipping. If there is any damage, notify your Dealer or the nearest Hanna Customer Service Center.

The meters are supplied complete with:

- [HI1131B](#) Glass body Combination pH Electrode
- [HI7662-W](#) Temperature probe
- [HI7082S](#) Electrolyte Solution
- [HI76404W](#) Electrode Holder
- pH Calibration Solutions Kit
- Capillary dropper pipette
- 12 Vdc Power Adapter
- Instruction Manual and Quick Reference Guide
- Certificate

[HI5221-01](#) and [HI5222-01](#) are supplied with 12 Vdc/120 Vac adapter.

[HI5221-02](#) and [HI5222-02](#) are supplied with 12 Vdc/230 Vac adapter.

Note: Save all packing material until you are sure that the instrument works properly. Any defective item must be returned in the original packing with the supplied accessories.

HI5221 and **HI5222** are professional bench meters with a color graphic LCD for pH (with Calibration Check), ORP (Oxidation Reduction Potential), ISE (**HI5222** only) and Temperature measurements. The display can be configured as a single channel or dual channel display (**HI5222** only). Each channel can be configured as pH, mV, Relative mV or ISE (**HI5222** only).

The main features of the instruments are:

- Single (**HI5221**) or two (**HI5222**) input channels;
- Capacitive touch keypad;
- pH calibration using up to five pH buffers: choose from the list of Hanna buffers (pH 1.68, 3.00, 4.01, 6.86, 7.01, 9.18, 10.01 and 12.45) or custom buffers (up to 5 custom buffers);
- ISE calibration using up to five standards: choose from the list of nominal standard values (e.g. for ppm: 0.010, 0.100, 1.00, 10.0, 100, 1000, 10000 ppm) and/or from 5 user-supplied custom standard values (up to 5 custom solutions);
- AutoHold feature to freeze first stable reading on the LCD;
- Two selectable alarm limits;
- User Selectable logging modes: Automatic logging, Manual logging with or without AutoHold;
- Continuous Lot logging directly on meter, with selectable log interval: Store up to 100,000 total data points;
- Up to 100 logging lots; a single lot can have up to 50,000 data points; **HI5222** (same for each measurement channel). Log files include GLP information;
- Basic Measurement can be viewed with detailed GLP information, or with a Graph or a Log History;
- User-friendly interface on large color graphic LCD (240 x 320 pixels) with user selectable color palette;
- PC interface via USB; download logged data to PC or use for Real time logging (**HI92000** PC application required);
- Dedicated Help key with contextual message;
- Profile feature: store up to ten different user setup (**HI5222** - five on each channel).

HI5221 DESCRIPTION

FRONT PANEL



REAR PANEL

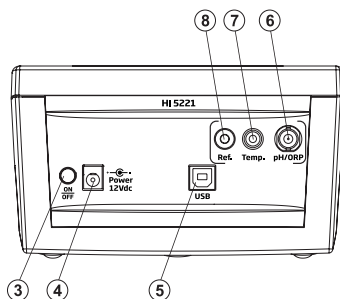

- 1) Liquid Crystal Display (LCD)
- 2) Capacitive touch keypad
- 3) ON/OFF switch
- 4) Power adapter socket
- 5) USB connector
- 6) BNC electrode connector for pH/ORP measurements
- 7) Temperature probe socket
- 8) Reference input socket

HI5222 DESCRIPTION

FRONT PANEL

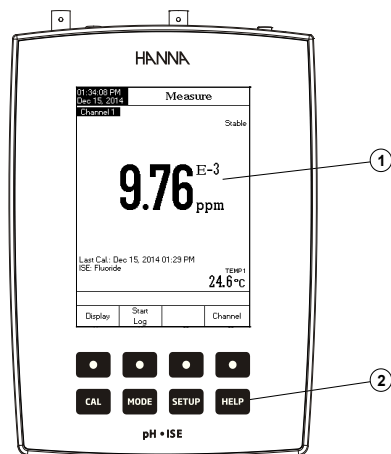

REAR PANEL

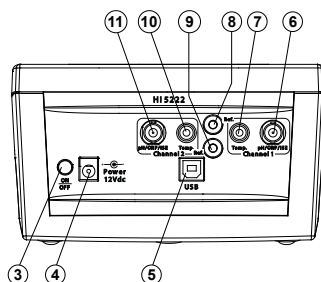

- 1) Liquid Crystal Display (LCD)
- 2) Capacitive touch keypad
- 3) ON/OFF switch
- 4) Power adapter socket
- 5) USB connector
- 6) BNC electrode connector for pH/ORP/ISE measurements (Channel 1)
- 7) Temperature probe socket (Channel 1)
- 8) Reference input socket (Channel 1)
- 9) Reference input socket (Channel 2)
- 10) Temperature probe socket (Channel 2)
- 11) BNC electrode connector for pH/ORP/ISE measurements (Channel 2)

KEYBOARD DESCRIPTION

FUNCTION KEYS

- CAL** To enter/exit calibration mode.
- MODE** To select the desired measurement mode, pH, mV, Rel mV (or ISE – HI5222 only).
- SETUP** To enter Setup (System, pH, mV or ISE) and to access Log Recall function.
- HELP** To obtain general information about the selected option/operation.

VIRTUAL KEYS

The upper row keys are assigned to the **virtual keys** placed on the bottom of the LCD, which allow you to perform the displayed function, depending on the current menu (e.g. for HI5222 Display, Start Log 1 and Channel in **Measure** mode).

Note: All the virtual keys are assigned to the highlighted channel (HI5222 only).

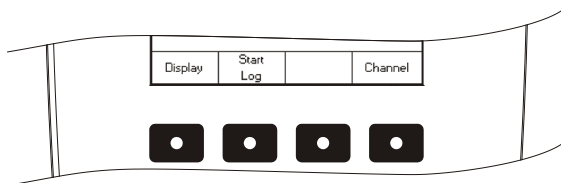

LCD GENERAL DESCRIPTION

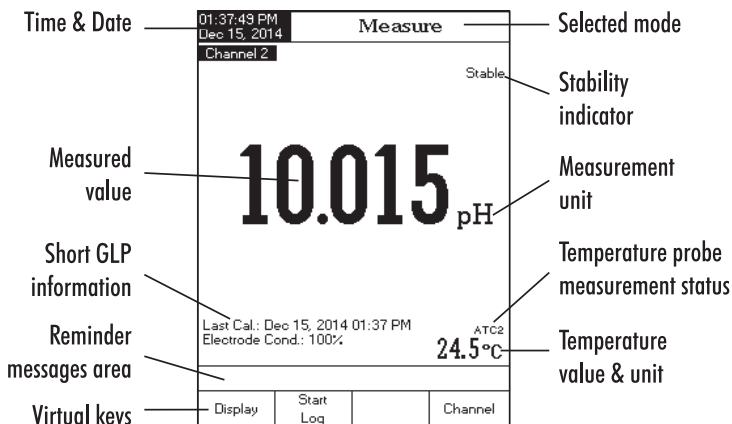

	HI5221	HI5222
Range	-2.0 to 20.0 pH / -2.00 to 20.00 pH / -2.000 to 20.000 pH	
	±2000.0 mV	
	-	e.g. 10 ⁻⁷ to 10 M, 0.005 to 10 ⁵ ppm, 5·10 ⁻⁷ to 5·10 ⁷ conc.
	-20.0 to 120.0 °C / -4.0 to 248.0 °F / 253.2 to 393.2 K	
Resolution	0.1 pH / 0.01 pH / 0.001 pH	
	0.1 mV	
	-	1, 2, 3 significant digit
	0.1 °C / 0.1 °F / 0.1 K	
Accuracy @25 °C / 77 °F	±0.1 pH / ±0.01 pH / ±0.002 pH ±1 last significant digit	
	±0.2 mV ±1 last significant digit	
	-	±0.5% (monovalent ions) ±1% (divalent ions)
	±0.2 °C / ±0.4 °F / ±0.2 K	
Relative mV offset range	±2000.0 mV	
pH Calibration	Up to five points calibration, 8 standard buffers available (pH 1.68, 3.00, 4.01, 6.86, 7.01, 9.18, 10.01, 12.45), and 5 custom buffers	
ISE Calibration	-	Up to five points calibration, seven fixed standard solutions available, for each measurement unit, and five custom solutions
Temperature User Calibration	3 points (0, 50, 100 °C)	
Input Channel	1 pH/mV	2 pH/mV/ISE
Temperature Compensation	Manual or Automatic	
GLP	Electrode offset / slope, calibration points, calibration time stamp, date, time and buffers/standards used	
Logging Record	Up to 100 lots, 50,000 records max/lot / maximum 100,000 data points/channel	
Logging Interval	14 selectable between 1 second and 180 minutes	
Logging Type	Automatic, Manual and Auto Hold	
pH Electrode	HI1131B	
Temperature Probe	HI7662-W	
PC Interface	Opto-isolated USB	
Input Impedance	10 ¹² Ω	
Display	Color Graphic LCD (240 x 320 pixels)	
Power Supply	12 Vdc adapter	
Environment	0 - 50 °C / 32 - 122 °F / 273 - 323 K max. 95% RH non-condensing	
Dimensions	160 x 231 x 94 mm (6.3 x 9.1 x 3.7")	
Weight	1.2 Kg (2.6 lbs.)	

POWER CONNECTION

Plug the 12 Vdc adapter into the power supply socket.

Notes: These instruments use non-volatile memory to retain the pH, ISE calibrations and all other settings, even when unplugged.

Make sure a fuse protects the main line.

ELECTRODE AND PROBE CONNECTIONS

For pH or ORP measurements, connect a pH/ORP electrode with internal reference to the BNC connector located on the rear panel of the instrument (to the desired channel - HI5222 only).

For ISE measurements, (HI5222 only) connect, to the desired channel, an ISE electrode with internal reference to the BNC connector located on the rear panel of the instrument.

For electrodes with a separate reference, connect the electrode's BNC to the BNC connector and the electrode's reference to the reference input socket.

For temperature measurement and automatic temperature compensation, connect the temperature probe to the appropriate socket (to desired channel - HI5222 only).

INSTRUMENT START UP

- Please ensure that the capacitive keypad is not covered by hand or other objects at the meter power on.
- Turn the instrument on from the power button located on the rear panel of the instrument.
- Please wait until the instrument finishes the initialization process.

Note: It is normal for the loading process to take a few seconds. If the instrument doesn't display the next screen, restart the meter using the power button. If the problem persists, contact your dealer.



CHANNEL SELECTION (HI5222 only)

- Press **Channel** while in **Measure** mode to access channel selection menu.

Four available options will be displayed: Channel 1, Channel 2, or multi-channel with the first or the second channel focused. The “Choose Channel Configuration” message is displayed in the Reminder messages area.

- Select the desired option by pressing the appropriate key: **Channel 1**, **Channel 1 Channel 2**, **Channel 1 Channel 2** or **Channel 1 Channel 2**.

The instrument will display in the selected option **Measure** mode.

11:23:44 AM Dec 15, 2014		Measure	
Channel 1		Stable	
9.66		E-3	
ppm		TEMP1	
Last Cal.: Dec 15, 2014 11:12 AM		ISE: Fluoride	
		24.8°C	
Channel 2		Stable	
7.090		pH	
Last Cal.: Dec 15, 2014 11:22 AM		Electrode Cond.: 100%	
		ATC2	
		25.2°C	
Choose Channel Configuration			
Channel 1	Channel 2	Channel 1	Channel 1
Channel 1	Channel 2	Channel 2	Channel 2

For each measurement mode (pH, mV, Rel mV or ISE) the following display configurations are available: Basic, Good Laboratory Practice (GLP) (pH, ISE only), Graph and Log History.

Basic

The main measured value and its units are displayed on the LCD, along with the temperature value, temperature probe status and basic calibration information when this option is accessed.

To choose the **Basic** display mode:

- Press **Display** while in **Measure** mode. The “Choose Display Configuration” message will be displayed in the Reminder messages area.
- Press **Basic**. The instrument will display the basic information for the selected measurement mode.

11:29:30 AM Dec 15, 2014		Measure	
Channel 2		Stable	
7.802		pH	
Last Cal.: Dec 15, 2014 11:27 AM		Electrode Cond.: Unknown	
		ATC2	
		25.2°C	
Display	Start Log		Channel

11:29:28 AM Dec 15, 2014		Measure	
Channel 1		Stable	
9.66		E-3	
ppm		TEMP1	
Last Cal.: Dec 15, 2014 11:12 AM		ISE: Fluoride	
		24.9°C	
Channel 2		Stable	
4.075		pH	
Last Cal.: Dec 15, 2014 11:27 AM		Electrode Cond.: Unknown	
		ATC2	
		25.2°C	
Display	Start Log1		Channel

GLP

Detailed GLP data will be displayed on the LCD for pH Measure and ISE Measure modes only when this option is selected: Last Calibration date and time, Offset and Slope values, Calibration Buffers/Standards and general information regarding the buffers/standards: the calibration temperature, temperature compensation mode, date and time. For **pH Measure**, the Electrode Condition is also displayed on the LCD in percent.

Note: If a one point pH calibration is performed or the current calibration does not include at least two consecutive standard buffers of pH 4.01, 7.01 (6.86) and 10.01 (9.18) buffers, the Electrode Condition will be unknown. Electrode condition remains active for 24 hours after a calibration.

To access the **GLP** display option:

- Press **Display** while in **Measure** mode. The “Choose Display Configuration” message will be displayed in the Reminder messages area.
- Press **GLP**. The instrument will display the detailed GLP data.

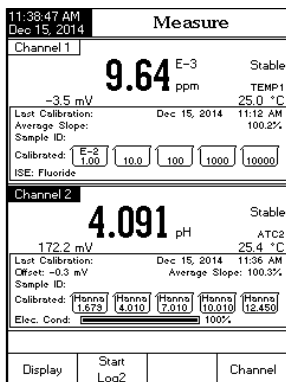
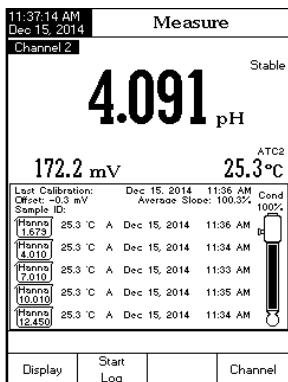

Graph

The on-line graph with currently logged values (pH, mV, Rel mV, or ISE vs. Seconds) will be displayed when this option is selected.

If there is no active log, the previously logged data for the selected parameter will be shown.

To access the **off-line / on-line graph**:

- Press **Display** while in **Measure / Logging** mode. The “Choose Display Configuration” message will be displayed in the Reminder messages area.
- Press **Graph**. Press **Start Log** to begin an online graph.

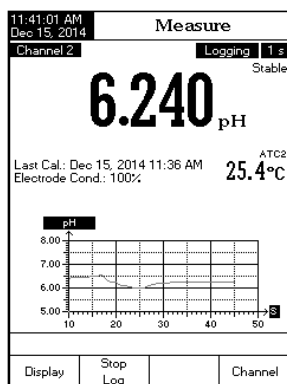
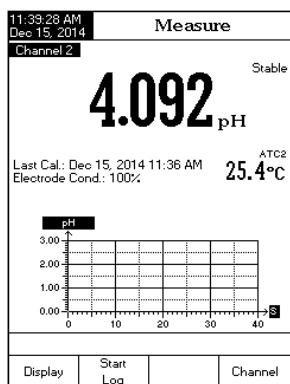

To Zoom Graph

- Press **Display** then **Graph**, **<** and **>** will appear in virtual keys.
- Use **<** and **>** to move along the X (Time) axis of the graph.
- Press **SETUP** to access the zoom menu for Y axis. Use **Zoom IN** or **Zoom OUT** for zooming Y (parameter) axis.
- Press **Escape** to return to the main menu.

When the **off-line graph** is displayed:

- Use the arrow keys to move along the X (Time) and Y (parameter) axes of the graph.
- Press **SETUP** to access the zoom menu for X and Y axes. Use **Zoom Time** or **Zoom pH** / **Zoom Rel mV** / **Zoom ISE** to switch between the active zooming axes. Press **Zoom IN** or **Zoom OUT** to zoom the selected axis.

*Note: While in zoom graph menu the **MODE** key is not accessible.*

*Press **Escape** to return to the main menu.*

Log History

The measurement, along with **Log History**, will be visible when this option is selected:

- 1) The last stored logged data (Not actively logging) or
- 2) The last data logged from an active logging lot or
- 3) An empty display - NO LOTS saved, NOT currently logging

The log history list also contains the appropriate mV values, the logged temperature, the temperature probe status source, as well as the records time stamp.

To access the **Log History** display option:

- Press **Display** while in **Measure** mode. The “Choose Display Configuration” message will be displayed in the Reminder messages area.
- Press **Log History**. The instrument will display the log history regarding the selected **Measure** mode.

*Notes: When an alarm condition is active, all logged records will have an exclamation mark “!”
If logged in Auto Hold, logged records will have an “H”.*

12:12:53 PM Dec 15, 2014		Measure	
Channel 2		Stable	
5.782		pH	
Last Cal.: Dec 15, 2014 11:36 AM		ATC2	
Electrode Cond.: 100%		25.7°C	
pH	mV	Temp(°C)	Time
Display	Start Log	Channel	

12:13:57 PM Dec 15, 2014		Measure	
Channel 2		Logging 1 s	
5.622		pH	
Last Cal.: Dec 15, 2014 11:36 AM		ATC2	
Electrode Cond.: 100%		25.7°C	
pH	mV	Temp(°C)	Time
5.622	81.5	25.7 A	12:13:57PM
5.622	81.5	25.7 A	12:13:56PM
5.622	81.5	25.7 A	12:13:55PM
5.622	81.5	25.7 A	12:13:54PM
5.622	81.5	25.7 A	12:13:53PM
5.622	81.5	25.7 A	12:13:52PM
5.622	81.5	25.7 A	12:13:51PM
5.629	81.1	25.7 A	12:13:50PM
5.632	81.0	25.7 A	12:13:49PM
Display	Stop Log	Channel	

*If another Measure mode is selected, the Log History will reset.
If the temperature unit is changed, all logged temperature values will be automatically displayed in the new temperature unit.*

The **System Setup** menu allows the user to customize the user interface, view meter information, set the external serial communication interface and to restore the manufacturer settings.

Accessing System Setup

- Press **SETUP** while in **Measure** mode.
- Press **System Setup**. The system setup options will be displayed on the LCD.

To access a **System Setup** option:

- Use **△** or **▽** to highlight the desired option.
- Press **Select** to access the selected option.



The following is a detailed description of the **System Setup** option screen:

Beeper

This option allows the user to turn an acoustic warning signal on or off. This function can be used to signal 4 different events: a stable signal, an alarm state, when every key is pressed or when an incorrect key is pressed. Enable (or disable) the **Beeper** for these events. Disabling the **Beeper** will stop audible signals.

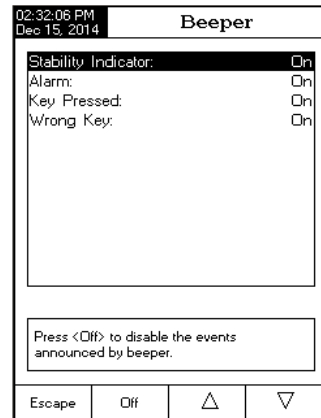

Saving Confirmation

Enable this option to force confirmation of a change made to a setting in GLP data option field or a **Sample ID** name. If **Saving Confirmation** is enabled, the user will have to accept the change with a key stroke. If **Saving Confirmation** is disabled, the changes made to these fields change automatically without asking for confirmation

GLP Data

Use this option to customize logging GLP information with specific identification data. When enabled, these ID tags will be included in the GLP section of all data logs for all modes of operation and both channels (**HI5222**). Each data field can use up to 10 characters.

The five available fields are:

Operator ID : used to add the name of the operator

Instrument ID : used to name an instrument with a discrete name, location or number

Company Name : used to include the Company ID to the GLP data field.

Additional Info : two data fields are available for general notes or notations.

To add the **GLP Data**:

- Press **SETUP** while in **Measure** mode.
- Press **System Setup**.
- Use **△** or **▽** to select the **GLP Data** option.
- Press **Select** and use **△** or **▽** to highlight the desired option.
- Press **Select** to edit the desired information. The Text Editor menu will be displayed on the LCD.
- Enter the desired information by accepting the highlighted character which is added to the text bar, using **Select**. The **▶** and **▽** keys help the user to select the desired character. It is also possible to delete the last character by positioning the cursor on the Backspace character (Ⓚ) and pressing **Select**.

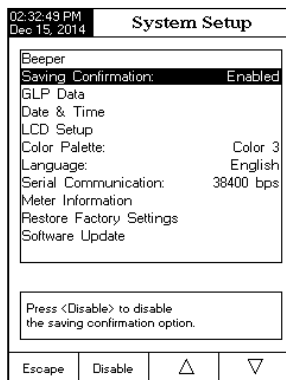

- Press **Escape** to return to the GLP Data options. If the Saving Confirmation is enabled, press **Yes** to accept the modified option, **No** to escape without saving or **Cancel** to return to the editing mode. Otherwise, the modified options are saved automatically.

Date & Time

Set the current date & time and the format in which they appear.

Set Date and Time

This option allows the user to set the current date (year/month/day) and time (hour/minute/second).

Notes: Only years starting with 2000 are accepted.

*The time is set using the selected time format. For 12 Hour time format only, the AM/PM can also be selected with **△** or **▽**.*

Set Time Format

Choose between 12-Hour (AM/PM) time format or 24-Hour time format.

Set Date Format

Choose the desired date format from 7 available options: DD/MM/YYYY, MM/DD/YYYY, YYYY/MM/DD, YYYY-MM-DD, Mon DD, YYYY, DD-Mon-YYYY or YYYY-Mon-DD.

To set the **Date & Time**:

- Press **SETUP** while in **Measure** mode.
- Press **System Setup**.
- Use **△** or **▽** to select the **Date & Time** option.
- Press **Select** and use **△** or **▽** to highlight the desired option you want to modify.
- Press **Select** to confirm your selection. Use **Next** / **Previous** to select next/previous entry to be edited. Press **Edit** and use **△** or **▽** to set the desired value, then press **Accept** to save the modified value (for **Set Date and Time** option). For the **Set Date Format** option press **Select** to confirm your selection and select one of the displayed options with **△** or **▽**.
- Press **Select** to confirm your selection and return to the **Date & Time** options or press **Escape** to cancel operation.

02:38:08 PM Dec 15, 2014		Date & Time	
Enter the date and time:			
year	month	day	
2014	12	15	
hour	minute	second	
02	37	49	PM
Press <Escape> to exit to previous screen. Press <Edit> to edit the focused entry. Press <Next> or <Previous> to select entry.			
Escape	Edit	Next	Previous

Note: If the time is changed with more than one hour before last pH/ISE calibration, a pop-up warning will appear on the LCD, notifying the user that a date/time conflict has occurred and some time-dependent modes could work improperly (e.g. Measure, GLP, Log).

LCD Setup

This option allows the user to set the Contrast, the Backlight of the LCD and the Backlight Saver. The Contrast parameter can be adjusted within 7 steps, while the Backlight parameter within 8 steps. The Backlight Saver can be set from 1 to 60 minutes or it can be OFF (disabled). All the changes are visible on the LCD for each parameter.

Note: If the instrument backlight turns off after the set period of time, press any key to turn it back on.

To set the **LCD Setup**:

- Press **SETUP** while in **Measure** mode.
- Press **System Setup**.
- Use **Δ** or **∇** to select the **LCD Setup** option.
- Press **Select** and use **Next** key to highlight the desired parameter.
- Use **Δ** or **∇** to adjust the contrast / backlight or to set the desired backlight saver time.
- Press **Escape** to confirm the modified options and return to the System Setup menu.

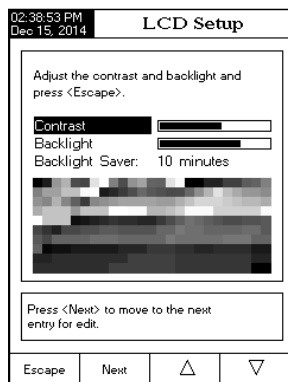

Color Palette

This option allow the user to choose desired color palette.

To select the Color Palette:

- Press **SETUP** while in **Measure** mode.
- Press **System Setup**.
- Use **Δ** or **∇** to select the **Color Palette** option.

Color 1	White background blue text
Color 2	Blue background white text
Color 3	White background black text
Color 4	Black background white text

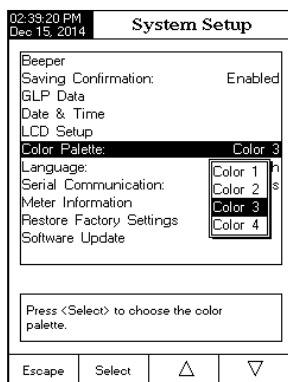

- Press **Select** and use **△** or **▽** to highlight the desired color.
- Press **Select** to confirm your selection and return to the System Setup menu or press **Escape** to return to the System Setup menu without changing.

Language

This option allows the user to choose the desired language in which all information will be displayed.

To select the **Language**:

- Press **SETUP** while in **Measure** mode.
- Press **System Setup**.
- Use **△** or **▽** to select the **Language** option.
- Press **Select** and use **△** or **▽** to highlight the desired language.
- Press **Select** to confirm your selection and return to the System Setup menu or press **Escape** to return to the System Setup menu without changing.



Serial Communication

This option allows the user to set the desired speed for the serial communication (baud rate) in bps. The meter and the PC program must have the same baud rate.

To set the **Serial Communication**:

- Press **SETUP** while in **Measure** mode.
- Press **System Setup**.
- Use **△** or **▽** to select the **Serial Communication** option.
- Press **Select** and use **△** or **▽** to highlight the desired baud rate.
- Press **Select** to confirm your selection and return to the System Setup menu or press **Escape** to return to the System Setup menu without changing.



Meter Information

This option provides general information about the instrument serial number (each instrument has a unique identification serial number), the software version and the factory calibration date and time (for mV and temperature).

Note: All instruments are factory calibrated for mV and temperature. One year after factory calibration, a warning message "Factory Calibration Expired" will be displayed when powering up the instrument. The instrument will still function, however, it should be taken to the nearest Hanna Customer Service for factory calibration.

To view the **Meter Information**:

- Press **SETUP** while in **Measure** mode.
- Press **System Setup**.
- Use **Δ** or **∇** to select the **Meter Information** option.
- Press **Select** to access the **Meter Information** menu.
- Press **Escape** to return to the System Setup menu.

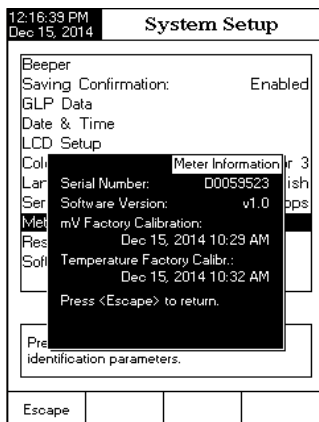

Restore Factory Settings

This option allows the user to erase all user settings and reset the instrument to the default factory settings in pH mode.

To restore the **Factory Settings**:

- Press **SETUP** while in **Measure** mode.
- Press **System Setup**.
- Use **Δ** or **∇** to select the **Restore Factory Settings** option.
- Press **Select** to confirm your selection. A pop-up menu will be displayed, asking for confirmation.
- Press **Yes** to confirm your selection and return to the System Setup or press **No** to return to the System Setup menu without restoring defaults.
- Press **Escape** to return to **Measure** mode.



Software update

This function allows the user to update instrument software. In order to start the PC upgrade application, you need to select the proper baud rate, the software update package and start the update.

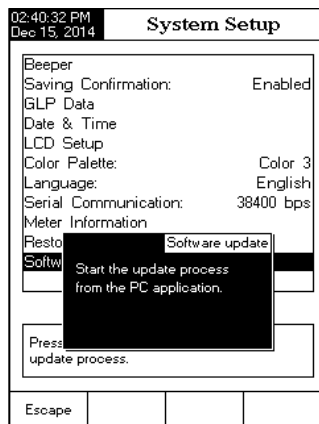

The **pH Setup** menu allows the user to set the parameters associated with pH measurement and calibration. These parameters can be set specifically for each channel (**HI5222** only). The settings will be applied only to the active channel.

Accessing pH Setup

- Press **MODE** while in **Measure** mode and then **pH** to select pH range for the desired channel.
- Press **SETUP** and then **pH Setup** to access **pH Setup** menu.

To access a **pH Setup** option:

- Use **Δ** or **∇** to highlight the desired option.
- Press **Select** to access the selected option.



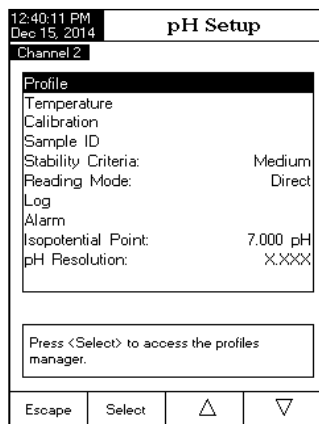

The following is a detailed description of the **pH Setup** option screens.



Profile

This option opens the **Profile** manager. Enabling **Profile** allows the user to Save, Load or Delete an application **Profile**. The **Profile** option allows the user to store up to ten separate profile applications (HI5222 - five profiles for each channel). Each Profile can be named and recalled at a moment's notice. A profile is a sensor setup complete with measurement units, logging and display preferences, calibration standards (Buffer or Standards including custom), setup of the Display screen for measurement (i.e. single, dual, graphing, GLP) and any other sensor configuration. Once saved, the exact same profile can be used at another time. This is a handy feature if the meter is used occasionally for additional applications because it saves time in the setup of the meter and ensures that the same procedure will be used.

To save the measurement configuration for pH mode:

- Press  and use  or  to highlight Profile.
- Press  /  to enable / disable this feature.

The available options are:

Save Profile: save the current profile.









Save Profile As...: save current profile using a specific name.

Load Profile: load from available profiles.



Delete Profile: delete a profile.

Save Current Profile

To save the current profile:

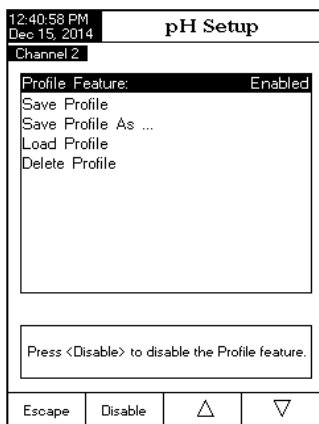
- Use  or  to select Save Profile As...
- Press . The Text Editor box will be displayed on the LCD.
- Enter the desired profile name by using  and  to highlight the desired character and then press  to add it to the text bar. It is also possible to delete the last character by positioning the cursor on the Backspace character () and pressing .
- Press  to return to the **Profile** options.
- Use **Save Profile** to save changes made to a presently used **Profile**. Changes will overwrite existing configurations.



- Select **Load Profile** to select a profile to use from the list of saved profiles. Highlight the desired profile and press .
- Select **Delete Profile** to remove a selected profile from the saved list. Highlight the profile and press .

Temperature

The temperature has a direct influence on pH. This option allows the user to choose the temperature source and units, as well as the desired manual temperature for manual temperature compensation mode.

Temperature Source (HI5222 only)













If using a temperature probe, Automatic Temperature Compensation will be performed relative to the displayed temperature, with the “ATC” indicator displayed on the LCD. For the HI5222, one temperature probe can be used for both measurement channels if desired. Select the source by selecting Manual, Channel 1 or Channel 2 . If no temperature probe is detected, Manual Temperature Compensation will be performed, with the “MTC” indicator on the LCD.

Temperature Unit

The desired temperature unit can be chosen (Celsius, Fahrenheit or Kelvin degrees) and the meter will automatically make the conversion for the selected unit.

If no temperature probe is connected, the desired temperature can be set manually. The default setting is 25.0 °C. If the measured temperature is different, the value can be manually adjusted to obtain an accurate pH measurement.

To set one of the **Temperature** options:

- Press  while in **pH Measure** mode.
- Press .
- Use  or  to select the **Temperature** option.
- Press  and use  or  to highlight the desired **Temperature** option you wish to modify.
- Press  and use  or  to highlight the desired option (for Temperature Source & Unit options) or use  or  to adjust the temperature value between the displayed limits (for Manual Temperature option).

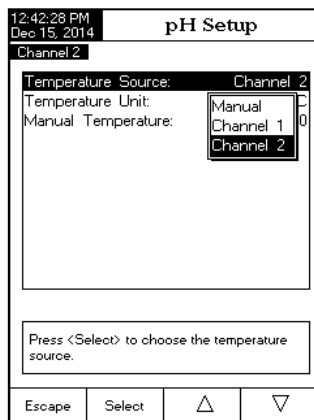

- Press **Select** to confirm your selection (for Temperature Source & Unit options) or press **Accept** to save the current value (for Manual Temperature option). Otherwise, press **Escape** to cancel operation.

Calibration

This option allows the user to setup desired buffers and calibration reminder.

Buffer Entry Type

Three settings are available for the pH buffers used for electrode calibration:

Automatic - the instrument automatically selects the closest buffer to the measured pH value from the predefined buffers chosen in the option **Edit Buffer Group**.

Semiautomatic - the instrument automatically selects the closest buffers to the measured pH value from all available buffers and you can choose the one used to be, from standard and custom buffers.

Manual Selection - the desired pH buffer is manually selected from all available buffers (standard and custom).

To set the **Buffer Entry Type**:

- Press **SETUP** while in **pH Measure** mode.
- Press **pH Setup**.
- Use **Δ** or **∇** to select the Calibration option.
- Press **Select** and use **Δ** or **∇** to highlight the **Buffer Entry Type** option.
- Press **Select** and use **Δ** or **∇** to highlight the desired option.
- Press **Select** to confirm your selection or press **Escape** to cancel operation.

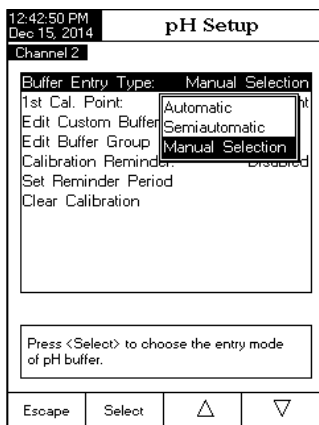

1st Cal. Point

Two options are available for the **1st Cal. Point** parameter: Point and Offset.

Point: A new buffer can be added to an existing calibration. The electrode slope will be reevaluated with the addition of this buffer (normal operation).

Offset: The new buffer calibration point can create a constant offset to all existing pH calibration data (existing calibration must have a minimum of two pH buffers).

To set the **1st Cal. Point**:

- Press **SETUP** while in **pH Measure** mode.
- Press **pH Setup**.
- Use **Δ** or **∇** to select the Calibration option.
- Press **Select** and use **Δ** or **∇** to highlight the **1st Cal. Point** option.
- Press **Point** / **Offset** as desired.
- Press **Escape** to return to previous menu.

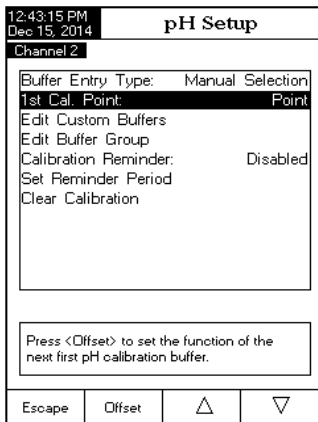

Edit Custom Buffers

If special custom pH buffers are required during calibration, the **Edit Custom Buffers** option is available. Up to five pH custom buffers can be added. If a custom buffer is used, the user must verify it's value at temperature of calibration.

To edit/set the **Custom Buffers**:

- Press **SETUP** while in **pH Measure** mode.
- Press **pH Setup**.
- Use **Δ** or **∇** to select the Calibration option.
- Press **Select** and use **Δ** or **∇** to highlight the **Edit Custom Buffers** option.
- For a previous set value, press **Invalidate Buffer** to set the custom buffer value to "----" if desired and confirm the setting by pressing **Yes**, otherwise press **Edit Buffer** to edit the selected custom buffer.
- While in edit custom buffer menu press **Reset Buffer** to set the custom buffer value to 7.000 pH and then use **Δ** or **∇** to set the desired custom buffer value.

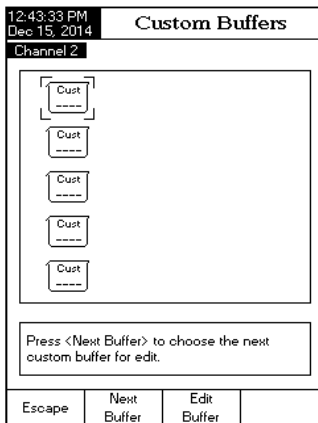

- Press **Escape** to exit custom buffer edit menu. If the Saving Confirmation is enabled, press **Yes** to accept the modified option, **No** to escape without saving or **Cancel** to return to the editing mode. Otherwise, the modified option is saved automatically.
- Use **Next Buffer** key to select the next custom buffer to be set or press **Escape** to return to Calibration options.

Edit Buffer Group

Accessing this option, the user can edit the desired group of five pH buffers for automatic buffer recognition (Automatic Buffer Entry Type). If the **Buffer Group** already contains five pH buffers, at least one pH buffer has to be removed in order to add another buffer.

To edit/set the **Buffer Group**:

- Press **SETUP** while in **pH Measure** mode.
- Press **pH Setup**.
- Use **Δ** or **∇** to select the Calibration option.
- Press **Select** and use **Δ** or **∇** to highlight the **Edit Buffer Group** option.
- Press **Select** and use **▶** and **∇** to choose the pH buffer to be included in the buffer group.
- Press **Add** or **Remove** to add/remove the selected pH buffer to/from the buffer group.
- Press **Escape** to return to Calibration options and to save the changes.

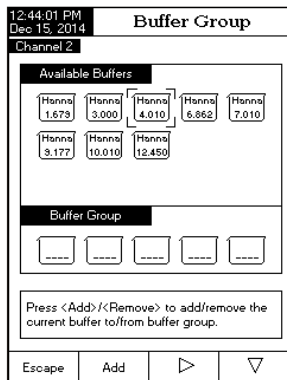

Calibration Reminder

This option allows the user to select a calibration reminder schedule if desired. Three options are available for the calibration reminder: Daily, Periodic or Disabled.

To set the **Calibration Reminder**:

- Press **SETUP** while in **pH Measure** mode.
- Press **pH Setup**.
- Use **Δ** or **∇** to select the Calibration option.

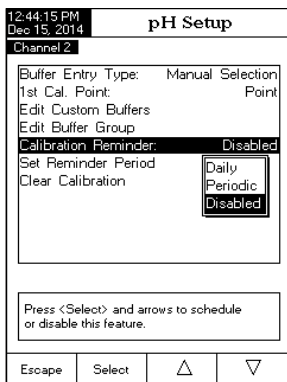

- Press **Select** and use **Δ** or **∇** to highlight the **Calibration Reminder** option.
- Press **Select** and use **Δ** or **∇** to highlight the desired option.
- Press **Select** to confirm your selection or press **Escape** to cancel operation.

Set Reminder Period

Schedule the calibration reminder timing with this option (verify Daily or Periodic is set for Calibration Reminder).

If a **Daily reminder** is desired, set the time of day you wish the reminder to occur.

If a **Periodic reminder** is desired, schedule time in days, hours and/or minutes after the last calibration for the reminder to occur.

To set the **Reminder Period**:

- Press **SETUP** while in **pH Measure** mode.
- Press **pH Setup**.
- Use **Δ** or **∇** to select the Calibration option.
- Press **Select** and use **Δ** or **∇** to highlight the **Set Reminder Period** option.
- Press **Select** and use **Next** / **Previous** to select next/previous entry to be edited.
- Press **Edit** and use **Δ** or **∇** to set the desired value, then press **Accept** to save the modified value.
- Press **Escape** to return to the Calibration options. If the Saving Confirmation is enabled, press **Yes** to accept the modified option, **No** to escape without saving or **Cancel** to return to the editing mode. Otherwise, the modified option is saved automatically.

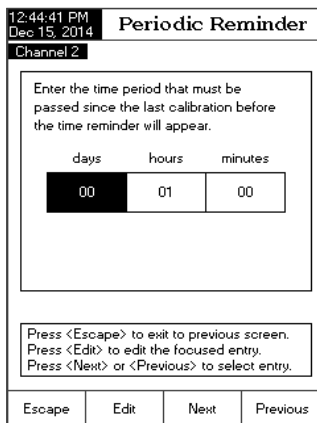

Clear Calibration

This feature deletes the pH electrode calibration for the attached electrode and channel (**HI5222**). A default meter calibration will replace the actual electrode calibration until a new electrode calibration is made.

To clear Calibration:

- Press **SETUP** while in **pH Measure** mode.
- Press **pH Setup**.
- Use **Δ** or **∇** to select the Calibration option.
- Press **Select** and use **Δ** or **∇** to highlight the **Clear Calibration** option.
- Press **Select** to clear calibration. A pop-up menu will be displayed asking for confirmation (when a calibration is available).
- Press **Yes** to confirm or press **No** to escape without saving and return to the Calibration options.

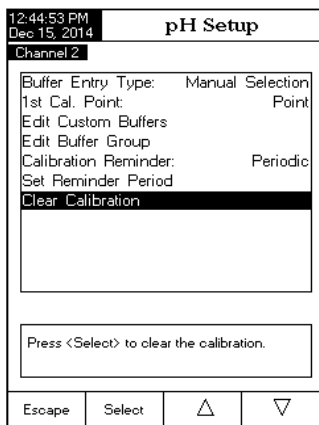

Sample ID

This option allows the user to assign an identification number/name. Two **Sample ID** options are available: ID Increment and Edit Sample ID.

ID Increment

Two choices are available for the sample ID:

None - the sample ID will be fixed and it can be set alphanumeric (see Edit Sample ID).

Automatic - the sample ID will automatically increment by one for each new log lot.

To set the **ID Increment** mode:

- Press **SETUP** while in **pH Measure** mode.
- Press **pH Setup**.
- Use **Δ** or **∇** to select the **Sample ID** option.
- Press **Select** and use **Δ** or **∇** to highlight the **ID Increment** option.
- Press **None** / **Automatic** as desired.
- Press **Escape** to return to previous menu.

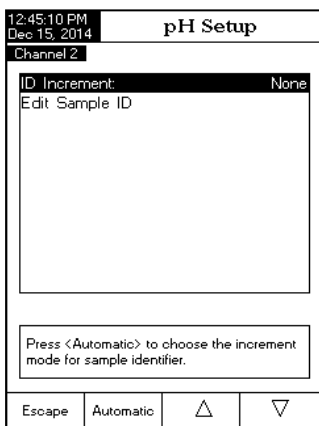

Edit Sample ID

This option allows the user to edit the sample ID.

Note: The ID Increment mode must be set to None, to use this feature.

To edit the Sample ID:

- Press **SETUP** while in **pH Measure** mode.
- Press **pH Setup**.
- Use **Δ** or **∇** to select the **Sample ID** option.
- Press **Select** and use **Δ** or **∇** to highlight the **Edit Sample ID** option.
- Press **Select** to confirm your selection.
- If the selected increment is None, the Text Editor menu will be displayed on the LCD, allowing you to enter the desired sample number/name by accepting the highlighted character which is added in the text bar, using **Select**. The **▶** and **∇** keys help the user to select the desired character.

It is also possible to delete the last character; position the cursor on the Backspace character and press **Select**.

- Press **Escape** to return to **Sample ID** options. If the Saving Confirmation is enabled, press **Yes** to accept the modified option, **No** to escape without saving or **Cancel** to return to the editing mode.

Otherwise, the modified options are saved automatically.

- If the selected increment mode is Automatic, the desired sample ID value can be set using **Δ** or **∇**.
- Press **Accept** to save the current value or press **Escape** to cancel operation.

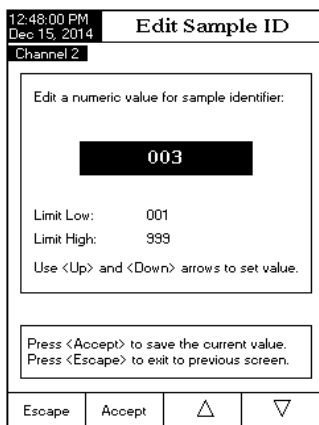
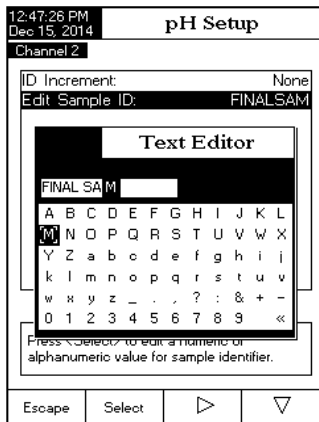

Stability Criteria

This option allows the user to select the signal stability criterion for the measured parameter (pH, mV, ISE):

Fast - this setting will give faster results with less accuracy.

Medium - this setting will give medium speed results with medium accuracy.

Accurate - this setting will give slower results with high accuracy.

To set the **Stability Criteria**:

- Press **SETUP** while in **pH Measure** mode.
- Press **pH Setup**.
- Use **Δ** or **∇** to select the **Stability Criteria** option.
- Press **Select** and use **Δ** or **∇** to highlight the desired option.
- Press **Select** to confirm your selection or press **Escape** to cancel operation.

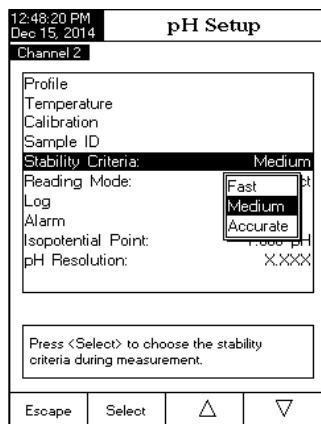

Reading Mode

This option allows the user to select between Direct and Direct/AutoHold pH reading mode. If choosing the AutoHold option, the current reading can be frozen on the LCD when **AutoHold** is pressed and the stability criterion is reached.

To set the **Reading Mode**:

- Press **SETUP** while in **pH Measure** mode.
- Press **pH Setup**.
- Use **Δ** or **∇** to select the **Reading Mode** option.
- Press **Direct** / **AutoHold** to select Direct / AutoHold option as desired.
- Press **Escape** to cancel operation.



Log

Note: See section Logging for available types of logging.

This option allows the user to edit the logging settings: Logging Type, Logging Data Configuration, Sampling Period and New Lot.

Logging Type

Three logging types are available: Automatic, Manual and Auto Hold.

Automatic - the measurement data is logged automatically at predefined time intervals;

Manual - a snapshot of the displayed measurement data is logged with time stamp when the user manually depresses Log;

Auto Hold - this is configured along with the Direct/AutoHold Reading Mode to take a snapshot of stable measurement data. Press to initiate a logging session. Press to initiate an Auto Hold event. The log occurs automatically once measurement stability is reached. This type log removes subjective data, as it only captures stable measurements.

To set the **Logging Type**:

- Press while in **pH Measure** mode.
- Press .
- Use or to select the **Log** option.
- Press and use or to highlight the **Logging Type** option.
- Press and use or to highlight the desired option.
- Press to confirm your selection or press to cancel operation.

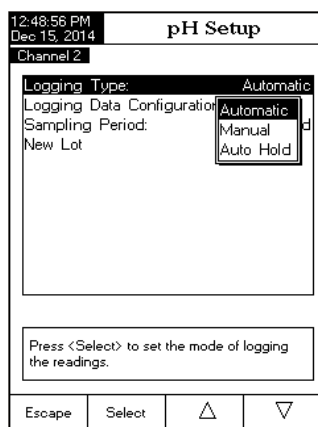

Logging Data Configuration

This option allows the user to select which additional parameters will accompany a log report: Date/Time, Calibration Data, Sample ID, Instrument ID, Operator ID, Company Name, Additional Info 1 and Additional Info 2.

To set the **Logging Data Configuration**:

- Press **SETUP** while in **pH Measure** mode.
- Press **pH Setup**.
- Use **Δ** or **∇** to select the **Log** option.
- Press **Select** and use **Δ** or **∇** to highlight the **Logging Data Configuration** option.
- Press **Select** and use **Δ** or **∇** to highlight the desired parameter to be logged in file.
- Press **Yes** to enable the parameter or **No** to disable it.
- Press **Escape** to return to previous menu.

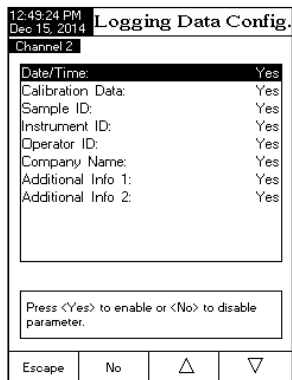

Sampling Period

This option allows the user to select the desired sampling period for automatic logging type.

To set the **Sampling Period**:

- Press **SETUP** while in **pH Measure** mode.
- Press **pH Setup**.
- Use **Δ** or **∇** to select the **Log** option.
- Press **Select** and use **Δ** or **∇** to highlight the **Sampling Period** option.
- Press **Select** and use **Δ** or **∇** to select the desired option.
- Press **Select** to confirm your selection or press **Escape** to cancel operation.

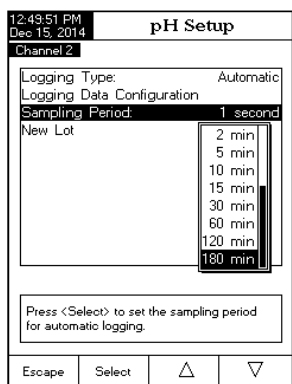

New Lot

This option is used to create a new lot when manual logging is used.

Note: If New Lot option is accessed and the Logging Type is Automatic, a warning message appears on the LCD informing the user that a new lot can be created only if the Logging Type is set as Manual.

To generate a **New Lot**:

- Press **SETUP** while in **pH Measure** mode.
- Press **pH Setup**.
- Use **Δ** or **∇** to select the **Log** option.
- Press **Select** and use **Δ** or **∇** to highlight the **New Lot** option.
- Press **Select** to generate a new manual lot. A pop-up menu will be displayed asking for confirmation.
- Press **Yes** to confirm or press **No** to escape without saving and return to the Log options.

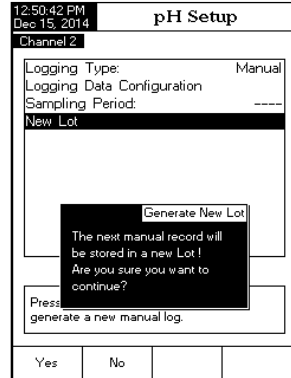

Alarm

This option allows the user to select the alarm settings: Alarm State and Alarm Limits. If the Alarm option is enabled, a continuous double beep will be heard, along with the “Alarm” indicator blinking on the LCD, each time the set limits in Measure mode are exceeded.

Note: Alarm Beeper must be set On for audible beep to be heard.

See: System Setup > Beeper > Alarm.

Alarm State

Three settings are available for the **Alarm State** option:

Disabled - the alarm will be disabled.

Inside Limits - the alarm state will trigger when the measured value is inside the set limits.

Outside Limits - the alarm state will trigger when the measured value is outside the set limits.

To set the **Alarm State**:

- Press **SETUP** while in **pH Measure** mode.
- Press **pH Setup**.
- Use **Δ** or **∇** to select the **Alarm** option.
- Press **Select** and use **Δ** or **∇** to highlight the **Alarm State** option.
- Press **Select** and use **Δ** or **∇** to highlight the desired option.
- Press **Select** to confirm your selection or press **Escape** to cancel operation.

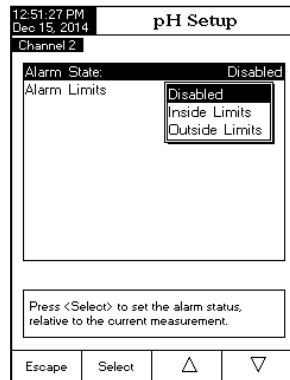

Alarm Limits

This option allows the user to set the alarm limits for the measured value.

Note: The Alarm High value can not be lower than the Alarm Low value.

To set the **Alarm Limits**:

- Press **SETUP** while in **pH Measure** mode.
- Press **pH Setup**.
- Use **Δ** or **∇** to select the **Alarm** option.
- Press **Select** and use **Δ** or **∇** to highlight the **Alarm Limits** option.
- Press **Select** and use **Next** / **Previous** to select next/previous entry to be edited.
- Press **Edit** and use **Δ** or **∇** to set the desired value, then press **Accept** to save the modified value.
- Press **Escape** to return to the Alarm options. The modified option is saved automatically.

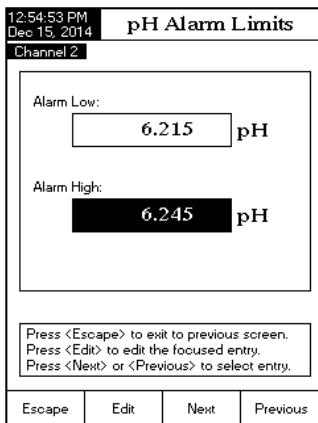

Isopotential Point

This option allows the user to edit the isopotential point of the electrode used for pH measurements. The isopotential point is the mV reading for an electrode at which temperature has no effect on the measurement. The ideal electrode has an isopotential point of 0.0 mV and 7.00 pH, while an actual electrode typically deviates slightly from the ideal values.

If the actual isopotential pH for an electrode is known, it can be set by accessing this option.

Note: If the isopotential point has been modified, recalibration must be performed.

To set the **Isopotential Point**:

- Press **SETUP** while in **pH Measure** mode.
- Press **pH Setup**.
- Use **Δ** or **∇** to select the **Isopotential Point** option.
- Press **Select** and set the desired isopotential pH value using **Δ** or **∇**.
- Press **Accept** to save the current value or press **Escape** to cancel operation.

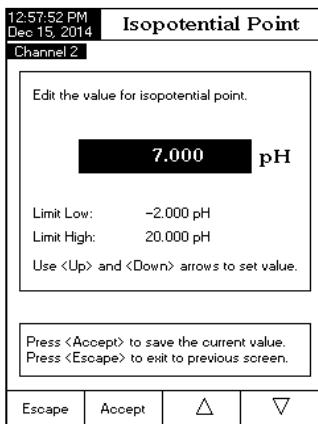

pH Resolution

Select the desired pH resolution with this option. Choose from one (X.X), two (X.XX) or three (X.XXX) digits displayed past the decimals.

To set the **pH Resolution**:

- Press **SETUP** while in **pH Measure** mode.
- Press **pH Setup**.
- Use **Δ** or **∇** to select the **pH Resolution** option.
- Press **Select** and use **Δ** or **∇** to highlight the desired option.
- Press **Select** to confirm your selection or press **Escape** to cancel operation.

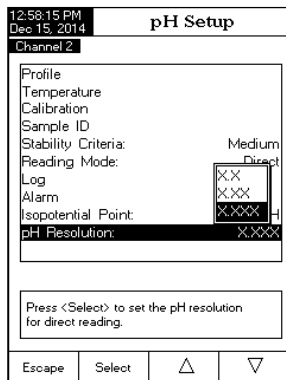

The mV Setup menu allows the user to set the parameters associated with mV and Relative mV measurements. These parameters can be set specifically for each channel (**HI5222** only). The settings will be applied only to the active channel.

Accessing mV Setup

- Press **MODE** while in **Measure** mode and then **mV** or **Rel mV** to select mV / Rel mV range for the desired channel.
- Press **SETUP** and then **mV Setup** to access mV Setup menu.

To access a mV Setup option:

- Use **Δ** or **∇** to highlight the desired option.
- Press **Select** to access the selected option.

The following is a detailed description of the **mV Setup** option screens.

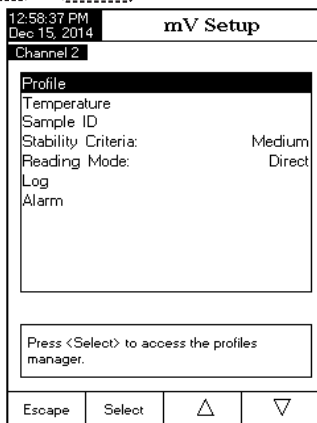

Profile- See pH Setup section.

Temperature

ORP measurements are not temperature compensated, although ORP values can change with temperature (e.g. reference electrode potential changes, sample equilibrium changes). It is important to report ORP values together with the reference electrode used and the temperature of measurement.

This option permits selection of the temperature source (HI5222 only) and measurement units.

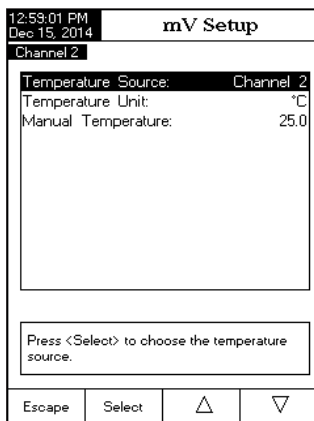

Temperature Source

If using a temperature probe, sample temperature will be displayed with the "ATC" indicator displayed on the LCD. For HI5222 only, the ATC option can be selected from Channel 1 or Channel 2. If no temperature probe is detected, a Manual set value will be displayed (and logged) with the measurement.

Temperature Unit

Select the desired temperature unit (Celsius, Fahrenheit or Kelvin degrees) and the meter will automatically convert to the selected unit.

Manual Temperature

If no temperature probe is connected, the desired temperature can be manually entered. The default setting is 25.0 °C.

Calibration (Relative mV only)

Calibration Reminder

This option allows the user to select a calibration reminder schedule if desired.

See pH Setup section > Calibration Reminder section for option access details.

Set Reminder Period

See pH Setup section > Set Reminder Period section.

Clear Calibration

This feature deletes the Relative mV calibration for the selected channel.

- Press **SETUP** while in **Rel mV** mode.
- Press **mV Setup** then use **△** or **▽** to access **Calibration** option.
- Press **Select** and use **△** or **▽** to highlight **Clear Calibration** option.
- Press **Select** to clear calibration. A pop-up menu will be displayed asking for confirmation (when a calibration is available).
- Press **Yes** to confirm or press **No** to escape without saving and return to the Calibration options.

Sample ID - See **pH Setup** section.

Stability Criteria - See **pH Setup** section.

Reading Mode - See **pH Setup** section.

Log - See **Logging** section, or **pH Setup** section.

Alarm - See **pH Setup** section.

The **ISE Setup** menu allows the user to set the parameters regarding ISE measurement and calibration. These parameters can be set specifically for each channel. The settings will be applied only to the active channel.

Accessing ISE Setup

- Press **MODE** while in **Measure** mode and then **ISE** to select ISE range for the desired channel.
- Press **SETUP** and then **ISE Setup** to access **ISE Setup** menu.

To access an **ISE Setup** option:

- Use **△** or **▽** to highlight the desired option.
- Press **Select** to access the selected option.

The following is a detailed description of the **ISE Setup** option screens.

12:59:30 PM Dec 15, 2014		ISE Setup	
Channel 2			
Profile			
Reading Mode:		Direct	
Temperature			
Calibration			
Electrode Type:		Fluoride	
Concentration Unit:		ppm	
Sample ID			
Stability Criteria:		Medium	
Log			
Alarm			
ISE Significant Digits:		XXX	
Press <Select> to access the profiles manager.			
Escape	Select	△	▽

Profile - See **pH Setup** section.

Reading Mode

This option allows the user to select the desired reading mode: **Direct**, **Direct/AutoHold**, **Known Addition**, **Known Subtraction**, **Analyte Addition** and **Analyte Subtraction**. Four of these Reading Modes are collectively known as **Incremental Methods** (see **ISE Theory** section for details). **Direct** measurements and **Direct/AutoHold** measurements are also available.

Direct

Direct measurements are analogous to taking pH measurements. The ISE is calibrated in ion standards and sample measurements are made directly. The ISE's manual should be consulted for tips and practices of making **Direct** measurements. The ion concentration can be read directly from the instrument.

Direct/AutoHold

Direct/AutoHold measurements are made similar to **Direct** measurements. The advantage of using **Direct/AutoHold** is a measurement that has not reached equilibrium will not be used. Only after the chosen stability criteria has been met will the meter go into the **Direct/AutoHold** mode. Using **Direct/AutoHold** removes the subjective nature of stability.

Known Addition

In the **Known Addition** method, a sample is measured with an ISE before and after the addition of a known volume of a standard. The mV difference is then used to calculate the concentration of the ion in the original sample.

Known Subtraction

In the **Known Subtraction** method, a sample is measured with an ISE before and after the addition of a known volume of a reactant standard. The reactant standard reacts with the measured ion in the sample, reducing its concentration. The mV difference is then used to calculate the concentration of the ion in the original sample. The stoichiometric ratio between reactant standard and ion in the sample must be known.

Analyte Addition

Analyte Addition is similar to the **Known Addition** method, with the difference being that an aliquot of sample is added to a known volume of standard. Both solutions contain the same measured ion. The standard is measured with an ISE before and after the addition of a known volume of a sample. The ion concentration is then calculated using the difference in mV potential. The sample should increase the concentration of the ion being measured.

Analyte Subtraction

In the **Analyte Subtraction** method, an aliquot of sample is added to a reactant standard of known concentration and volume. The sample partially reacts with the measured ion. The stoichiometric ratio between standard and sample must be known. The ion concentration is then calculated using the difference in mV potential.

To set the **Reading Mode**:

- Press **SETUP** while in **ISE Measure** mode.
- Press **ISE Setup**.
- Use **Δ** or **▽** to select the **Reading Mode** option.
- Press **Select** and use **Δ** or **▽** to highlight the desired option.
- Press **Select** to confirm your selection or press **Escape** to cancel operation.

01:00:45 PM Dec 15, 2014		ISE Setup	
Channel 2			
Profile:	JANE	Reading Mode:	Direct
Temperature	Direct	Calibration	Direct/Auto-Hold
Electrode Type:	Known Addition	Concentration Unit:	Known Subtraction
Sample ID	Analyte Addition	Stability Criteria:	Analyte Subtraction
Log	Alarm	ISE Significant Digits:	XXX
Press <Select> to choose the reading mode for ISE concentration measurements.			
Escape	Select	Δ	▽

Temperature

This option permits the user to configure all parameters related to ISE temperature measurements.

Temperature Source

The options are: Manual, Channel 1 or Channel 2. If no temperature probe is detected, a manually set value will be displayed (and logged) with the measurement. If a temperature probe is connected to either channel, it may be selected. The temperature measurement will be displayed and logged with the measurement and may be used for temperature compensation calculation if Temperature Compensation is enabled.

11:55:04 AM Dec 15, 2014		ISE Setup	
Channel 1			
Temperature Source:	Channel 1	Temperature Unit:	°C
Manual Temperature:	25.0	Temperature Compensation:	Enabled
Isopotential Point:	20.0 ppm		
Press <Select> to set the isopotential point value.			
Escape	Select	Δ	▽

Temperature Unit

Select the desired temperature unit (Celsius, Fahrenheit or Kelvin degrees) and the meter will automatically convert to the selected unit.

Manual Temperature

If no temperature probe is connected, the desired temperature can be set manually. The default setting is 25.0 °C. If the measured temperature is different, the value can be manually adjusted to obtain an accurate ion measurement.





Temperature Compensation

ISE measurements benefit from temperature compensated corrections if:

- standards and sample temperatures differ from each other
- the Isopotential Point of the ISE is known.

If sample and standards are made at the same temperature, leave this option disabled.

Isopotential Point

If the Temperature Compensation is enabled, the isopotential point of the ISE must be added in this parameter. Verify the Electrode Type and Concentration Unit are configured for the desired application. The Isopotential point will use the selected concentration unit. Use  and  to edit the isopotential point value and press  to save the value or press  to cancel operation.

Notes: A warning message will appear on the LCD informing the user to perform a new calibration.

A minimum of two ion standards is required for the ISE calibration.

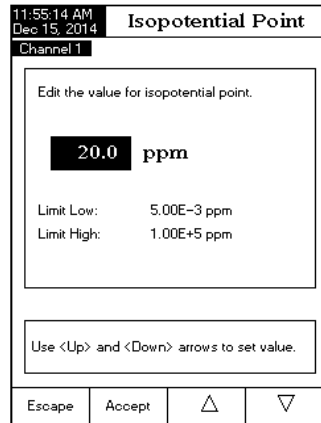

Calibration

This option allows the user to view and configure all ISE parameters related to ISE calibration.

Manual Entry

Two different standard groups can be used for calibration of ISE:

All Standards - During calibration the user can select the desired standards from a large list containing all the predefined standard values and the custom standards.

Group Standards - the user can pre-select a group of standards from the existent group of standards to be used during sensor calibration.

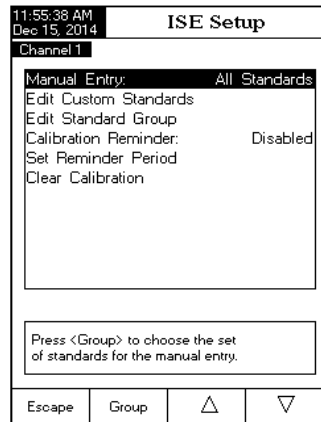

To set the **Manual Entry**:

- Press **SETUP** while in **ISE Measure** mode.
- Press **ISE Setup**.
- Use **Δ** or **∇** to select the **Calibration** option.
- Press **Select** and use **Δ** or **∇** to highlight the **Manual Entry** option.
- Press **All** or **Group** to select the desired option.

Edit Custom Standards

Use **Edit Custom Standards** function to add additional ISE standard values. Up to five custom standard values can be added. Set Electrode Type and Concentration Unit prior to adding these standards.

To edit/set the **Custom Standards**:

- Press **SETUP** while in **ISE Measure** mode.
- Press **ISE Setup**.
- Use **Δ** or **∇** to select the **Calibration** option.
- Press **Select** and use **Δ** or **∇** to highlight the **Edit Custom Standards** option.
- If you want to disable the custom standard, press **Invalidate Standard**. A pop-up menu will be displayed asking for confirmation. Press **Yes** to confirm (the custom standard value will turn to "----") or press **No** to cancel the operation.
- Use **Next Standard** key to select the next custom standard to be set.
- Press **Escape** to return to **Edit Custom Standard** options.

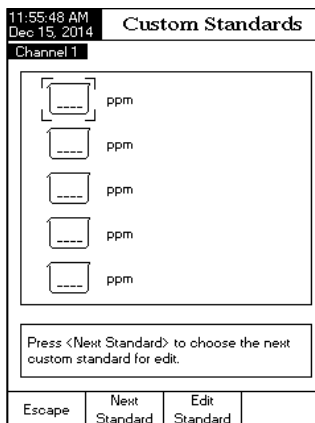











Edit Standard Group

If a Group Standard was selected in the parameter Manual Entry, this parameter is used to create your group of standards. If the Standard Group already contains five ISE standards, at least one ISE standard has to be removed in order to add another standard.

To edit/set the **Standard Group**:

- Press **SETUP** while in **ISE Measure** mode.
- Press **ISE Setup**.

- Use  or  to select the **Calibration** option.
- Press  and use  or  to highlight the **Edit Standard Group** option.
- Press  and use  and  to choose the ISE standard to be included in the standard group.
- Press  /  to add/remove the selected ISE standard to/from the standard group.
- Press  to return to **Calibration** options and to save the changes.

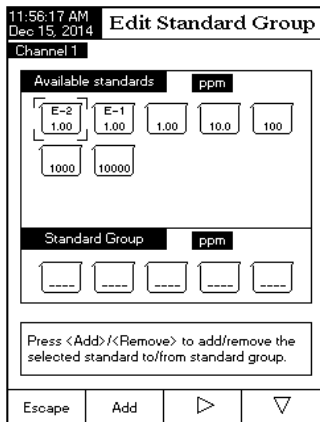

Calibration Reminder - See **Calibration** option from **pH Setup** section.







Set Reminder Period - See **Calibration** option from **pH Setup** section.

Clear Calibration - See **Calibration** option from **pH Setup** section.



Electrode Type

This option allows the user to select the desired Ion Selective Electrode used for measurements from a list: Ammonia, Bromide, Cadmium, Calcium, Carbon Dioxide, Chloride, Cupric, Cyanide, Fluoride, Iodide, Lead, Nitrate, Potassium, Silver, Sodium, Sulfate, Sulfide and five custom ISE. For the standard ISE it is possible to view the Ion constants (Name, Molar Weight and Electric Charge/Slope), while for the custom ISE all these constants can be manually set.

To set the **Electrode Type**:

- Press  while in **ISE Measure** mode.
- Press .
- Use  or  to select the **Electrode Type** option.
- Press  and use  or  to select the desired standard ISE or a custom one from the list.

For standard ISE:

- Press  to visualize the Ion Constants and then press  at any time to exit Ion Constants view mode.

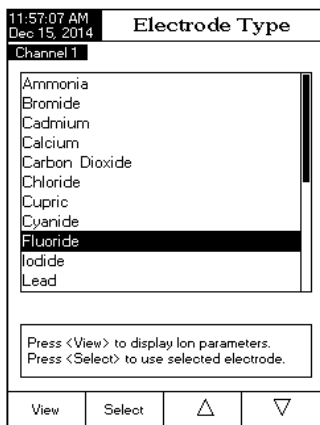

- Press **Select** to confirm your selection and return to ISE Setup options.

For custom ISE:

- Press **View** to edit the Ion Constants for the selected custom ISE. Use **Δ** or **∇** to select the desired constant and press **Select** to enter edit mode or **Escape** to cancel operation.
- For the ion Name the Text Editor menu will be displayed on the LCD. Enter the desired information by accepting the highlighted character which is added in the text bar, using **Select**. The **▶** and **∇** keys help the user to select the desired character. It is also possible to delete the last character by positioning the cursor on the Backspace character (⌫) and pressing **Select**. Press **Select** to return to the Ion Constants menu. If the Saving Confirmation is enabled, press **Yes** to accept the modified option, **No** to escape without saving or **Cancel** to return to the editing mode. Otherwise, the modified option is saved automatically.
- To set the appropriate Ion Molar Weight (in g/mol units) use **Δ** or **∇** to set the desired value and then press **Accept** to save the current value or press **Escape** to cancel operation.
- To select the appropriate Ion Charge/Slope use **Δ** or **∇** and then press **Select**. If the ion electric charge is None, its slope can be manually set by pressing **Edit**.

A pop-up menu will be displayed on the LCD, in which the slope value can be set using **Δ** or **∇**. Press **Accept** to save the modified value or press **Escape** to return to the previous menu.

11:57:26 AM Dec 15, 2014		Ion Constants	
Channel 1			
Name:	Fluoride		
Molar Weight:	18.998 g/mol		
Ion Charge/Slope:	-1 / -59.16		
Press <Escape> to return in previous panel.			
Escape			

11:57:59 AM Dec 15, 2014		Ion Molar Weight	
Channel 1			
Set the value for ion molar weight.			
10.000		g/mol	
Limit Low:	0.001 g/mol		
Limit High:	1000.000 g/mol		
Use <Up> and <Down> arrows to set value.			
Press <Accept> to save the current value. Press <Escape> to exit to previous screen.			
Escape	Accept	Δ	∇

Note: If an ISE calibration was performed and a different Ion Selective Electrode is selected (standard or custom), a warning message appears on the LCD informing the user to perform a new calibration or to select the previous ISE in order to perform accurate measurements.

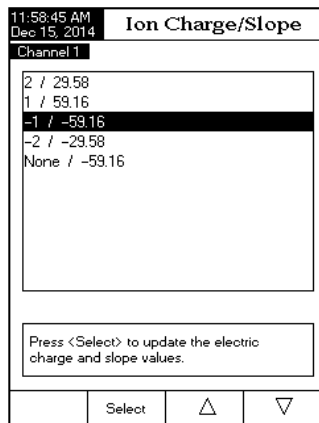

Concentration Unit

Select the desired concentration unit for the measured ion or chemical compound. The available concentration units are: ppt, g/L, ppm, mg/L, $\mu\text{g/mL}$, ppb, $\mu\text{g/L}$, mg/mL, M, mol/L, mmol/L, %w/v and User (custom unit).

To set the **Concentration Unit**:

- Press **SETUP** while in ISE Measure mode.
- Press **ISE Setup**.
- Use **Δ** or **∇** to select the **Concentration Unit** option.
- Press **Select** and use **Δ** or **∇** to highlight the desired option.
- Press **Select** to confirm your selection or press **Escape** to cancel operation.

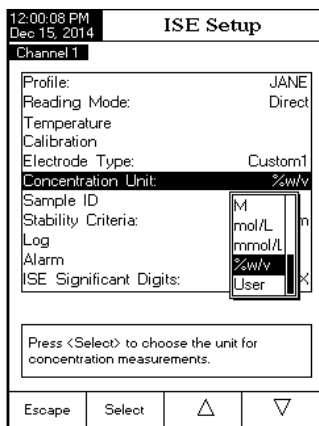

Sample ID - See **pH Setup** section.

Stability Criteria - See **pH Setup** section.

Log - See **pH Setup** section.

Note: The Logging Data Configuration option includes also the Ion Constants parameter. If you want it to appear in the log reports, it must be enabled.

Alarm - See **pH Setup** section.

Note: The Alarm Limits (Low and High) are set in the selected concentration unit of the measured

ISE Significant Digits

Accessing this option, the number of ISE significant digits can be set, with one (X), two (XX) or three (XXX) significant digits.

To set the **ISE Significant Digits**:

- Press **SETUP** while in ISE Measure mode.
- Press **ISE Setup**.
- Use **Δ** or **∇** to select the **ISE Significant Digits** option.
- Press **Select** and use **Δ** or **∇** to highlight the desired option.
- Press **Select** to confirm your selection or press **Escape** to cancel operation.

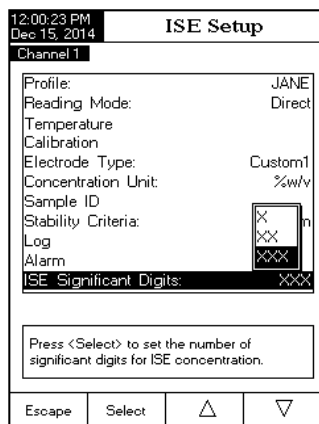

Calibrate the instrument often, especially if high accuracy is required.

The instrument should be recalibrated:

- Whenever the pH electrode is replaced.
- At least once a week.
- After testing aggressive chemicals.
- When "Electrode Cond. Unknown", "pH x Default Calibration" or "pH x Calibration Expired" message appears on the LCD, in the Reminder messages area. The "x" represents channel "1" or channel "2".

PREPARATION

Pour small quantities of the buffer solutions into clean beakers. If possible, use plastic beakers to minimize any EMC interferences.

For accurate calibration and to minimize cross-contamination, use two beakers for each buffer solution. One for rinsing the electrode and one for calibration.

If you are measuring in the acidic range, use pH 7.01 or 6.86 as first buffer and pH 4.01, 3.00 or 1.68 as second buffer. If you are measuring in the alkaline range, use pH 7.01 or 6.86 as first buffer and pH 10.01/9.18 or 12.45 as second buffer.

For extended range measurements (acidic and alkaline), perform a five points calibration by selecting five of the available buffers.

CALIBRATION PROCEDURE

There are 8 standard pH buffers that are temperature-compensated during pH calibrations: pH 1.68, 3.00, 4.01, 6.86, 7.01, 9.18, 10.01 and 12.45. The standard pH buffers are temperature compensated during calibration. Custom buffers require the user to use the actual buffer value at the temperature of use.

A minimum of a two point calibration using the standard pH buffers is required to determine the pH electrode condition. The buffers should bracket the sample measurement pH.

An extended pH measurement range will require calibration at multiple points. The meter is able of calibration with 5 pH buffers. For improved measurement accuracy, perform a multiple buffer calibration bracketing and including the pH range the sample measurements.

The buffer group that will be available during calibration was set in pH setup → Calibration Buffer Entry Type. The following example demonstrates pH electrode calibration if Manual selection was selected. In this case all of the 8 standard buffers will be available for calibration.

pH Calibration screen description

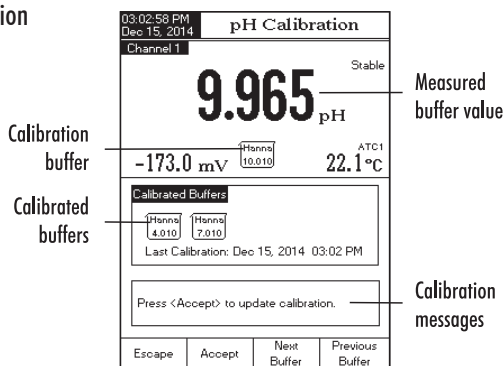

- Press **CAL**. If the instrument was calibrated before and calibration was not cleared, the old calibration can be cleared by pressing **Clear Cal**. After 10 seconds, **Clear Cal** will no longer be available.

Note: It is very important to clear calibration history when a new electrode is used because most errors and warning messages that appear during calibration depend on calibration history.

- Immerse the pH electrode and the temperature probe approximately 4 cm (1.5") into a buffer solution of your choice (pH 1.68, 3.00, 4.01, 6.86, 7.01, 9.18, 10.01, 12.45 or a custom buffer) and stir gently. The temperature probe should be close to the pH electrode.
- Select the pH calibration buffer used with Next Buffer or Previous Buffer. The "Please wait..." message will appear on the LCD until the reading is stable or the buffer is validated.
- If the pH buffer is validated, Accept will appear on the LCD. Press Accept to update calibration. The calibration buffer will be added to the Calibrated Buffers section.

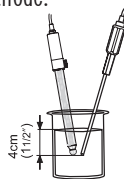

- Immerse the pH electrode and the temperature probe into the next buffer solution and follow the above procedure or press Escape to exit calibration.

Notes: The new added calibration point will replace an old one if the difference between them is ± 0.2 pH.

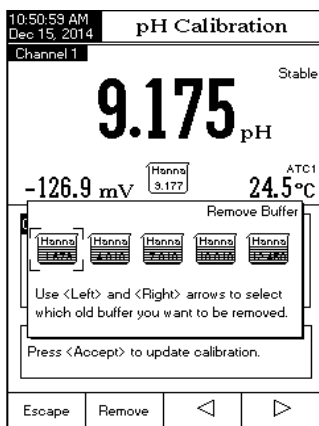

If the existing stored calibration is full (five calibration points), a pop-up menu will be displayed on the LCD in which you can select with < or > keys the buffer you want to replace with the current buffer. Press Remove to delete the selected buffer and then press Accept to update calibration with the new buffer.





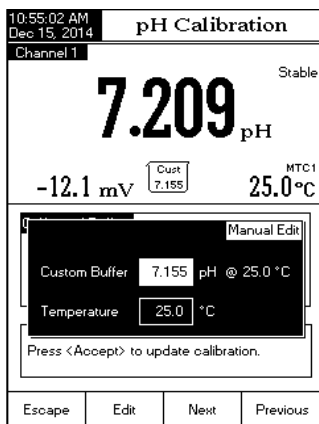

- If using manual temperature, after selecting the standard buffer, press SETUP. A pop-up menu will be displayed on the LCD in which the temperature value can be adjusted using Δ or ∇. Press Accept to save the new temperature value.

- If using Custom buffers, press SETUP after buffer has been accepted to change actual buffer conditions. A pop-up menu will be displayed on the LCD in which the custom buffer and the temperature value (MTC) can be adjusted by pressing Edit and then Δ or ∇ keys. Press Accept to save the modified value and then Next / Previous to select next/previous value to be adjusted.



- If the Automatic buffer entry type has been selected for the calibration procedure, the instrument will automatically select the closest buffer to the measured pH value from the edit buffer group (see pH Setup for details).
- If the Semiautomatic buffer entry type has been selected for the calibration procedure, the instrument will display only the closest buffers to the measured pH value from all the available buffers and the user must select with  or  the buffer being used

CALIBRATION MESSAGES

- **Move sensor to next buffer or check buffer:** this message appears when the difference between the pH reading and the value of the selected calibration buffer is significant. If this message is displayed, check if you have selected the appropriate calibration buffer.
- **Wrong buffer temperature:** this message appears if the buffer temperature is out of the defined buffer temperature range.
- **Clean the electrode or check the buffer. Press  to update calibration:** this message alerts the user that some dirt or deposits could be on the electrode. Refer to the electrode Cleaning Procedure.
- **Slope too low. Please check the buffer / Slope too high. Please check the buffer:** these messages appear if the current slope is under 80 % or over 110 % of default slope. Recalibrate the instrument using fresh buffers.
- **Slope too low. Press  to clear old calibration / Slope too high. Press  to clear old calibration:** verify the correct buffer has been selected and poured.
- **Unrecognized buffer. Please check the buffer or the buffer list** (for Semiautomatic and Automatic buffer entry type): this message appears if the current buffer value is not close to any of the buffers from the buffer list/group. Check if the current buffer is present in the buffer list or the appropriate buffer group was selected.
- **The current buffer was already calibrated:** change the buffer or press  to exit calibration mode.

Verify the pH electrode and instrument has been calibrated before making pH measurements.

DIRECT MEASUREMENT

To measure the pH of a sample using the Direct reading mode:

- Press **MODE** and then **pH** to select **pH Measure** mode (select channel first for **HI5222**).
- Select the Direct reading mode (see pH Setup for details).
- Place the electrode tip and the temperature probe approximately 4 cm (1.5”) into the sample to be tested. Allow time for the electrode to stabilize. “Stable” will appear.
- The measured pH value will be displayed on the LCD, together with a short GLP information and display preferences.

Note: If the reading is out of range, “—” will be displayed on the LCD.

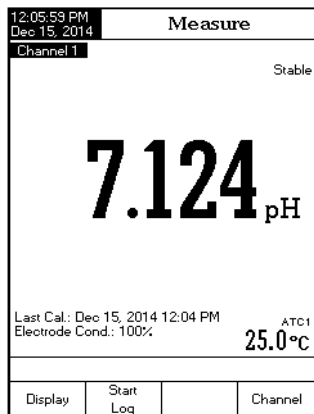

DIRECT/AUTOHOLD MEASUREMENT

To measure pH of a sample using the Direct/AutoHold reading mode:

- Press **MODE** and then **pH** to select **pH Measure** mode (for the selected channel - **HI5222** only).
- Select the Direct/AutoHold reading mode (see pH Setup for details).
- Place the electrode tip and the temperature probe approximately 4 cm (1.5”) into the sample to be tested.
- The measured pH value will be displayed on the LCD. Press **Auto Hold** and the “AutoHold” indicator will start blinking on the LCD until the stability criterion is reached. The pH value will be frozen on the LCD, along with “AutoHold” indicator.
- To return to normal **Measure** mode press **Continuous Reading**.

Note: If the reading is out of range, “—” will be displayed on the LCD.

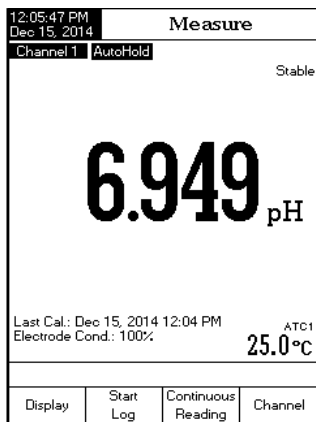

Outside Cal Range warns the user if the current reading is out of the calibrated area. The calibrated area is that part of the pH range in which the calibration point ensures an accurate reading. If the reading is taken out of the calibration area, the “**Outside Cal Range**” message will start blinking on the LCD. The calibrated area is calculated in accordance with the pH resolution used during the measurement. To avoid triggering this message, the buffer values have to be well-distributed in the desired measurement range.

If measurements are taken successively in different samples, it is recommended to rinse the electrode thoroughly with deionized water or tap water and then with some of the next sample before immersing it into the next sample solution.

The pH reading is affected by temperature. In order to measure the pH accurately, the temperature effect must be compensated. To use the Automatic Temperature Compensation (ATC) feature, connect and place the HI7662-W temperature probe into the sample as close as possible to the electrode and wait for a few seconds.

If the temperature of the sample is known, Manual Temperature Compensation (MTC) can be used by disconnecting the temperature probe.

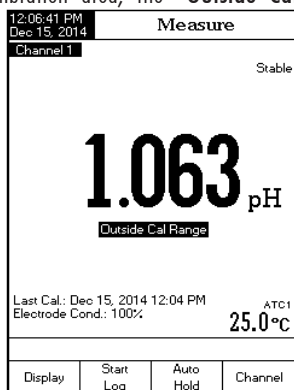

Notes: For single channel pH measurements (HI5221), “MTC” or “ATC” indicators will be displayed on the LCD, while for dual channel pH measurements (HI5222) “MTC1”/“MTC2” or “ATC1”/“ATC2” indicators will be displayed (Channel dependent).

For mV/Rel mV measurements, “NoProbe” or “TEMP” indicators will be displayed on the LCD (HI5221 only), respectively, “NoProbe 1”/“NoProbe 2” or “TEMP1”/“TEMP2” indicators (HI5222 only) for mV/Rel mV/ISE measurements, depending on the temperature probe status and channel selected.

When in MTC mode, the temperature can be modified by pressing for pH Measure mode and for mV /Rel mV Measure mode (HI5221 only) if the Reading Mode option is Direct (HI5222 only). The temperature value can be adjusted with or from -20.0 °C to 120.0 °C. Press to save the new temperature value or press to return to Measure mode.

When in ATC mode for pH, or TEMP for mV/Rel mV, “—” will be displayed on the LCD if the measured temperature is under or over temperature range (-20.0 °C to 120.0 °C).

mV/ORP MEASUREMENTS

Oxidation-reduction potential (ORP) measurements provide the quantification of the oxidizing or reducing power of the tested sample.

To correctly perform a redox measurement, the surface of the ORP electrode must be clean and smooth.

DIRECT MEASUREMENT

To measure the mV of a sample using the Direct reading mode:

- Press **MODE** and then **mV** to enter **mV Measure** mode (Select channel first for - HI5222 only).
- Select the Direct reading mode (see mV Setup for details).
- Place the tip of the ORP electrode 4 cm (1.5") into the sample to be tested and allow a few seconds for the reading to stabilize.
- The instrument will display the measured mV value on the LCD.

Note: If the reading is out of range, "—" will be displayed on the LCD.

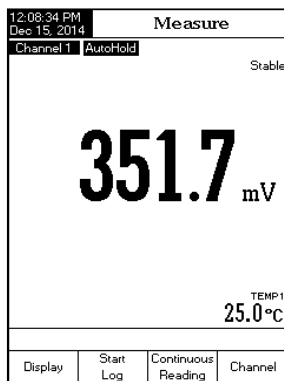

DIRECT/AUTOHOLD MEASUREMENT

To measure mV of a sample using the Direct/AutoHold reading mode:

- Press **MODE** and then **mV** to select **mV Measure** mode (Select channel first for - HI5222 only).
- Select the Direct/AutoHold reading mode (see mV Setup for details).
- Place the tip of the ORP electrode approximately 4 cm (1.5") into the sample to be tested.
- The measured mV value will be displayed on the LCD. Press **Auto Hold** and the "AutoHold" indicator will start blinking on the LCD until the stability criterion is reached. The mV value will be frozen on the LCD, along with "AutoHold" indicator.
- To return to normal **Measure** mode press **Continuous Reading**.

Note: If the reading is out of range, "—" will be displayed on the LCD.

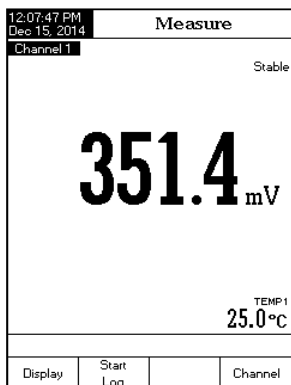

Relative mV MEASUREMENTS

To measure the Relative mV of a sample:

- Press **MODE** then **Rel mV** (select channel first for HI5222).
- Verify if a current calibration has been made.
- If required, conduct the single point Rel mV calibration. Verify the tip of the electrode is immersed into the known solution or ORP standard.
- Press **CAL**. Use **Δ** and **∇** keys set the standard value. Press **Accept** to store the calibration.
- Press **MODE** then **Rel mV** (select channel first for HI5222).
- Place calibrated sensor tip into the sample to be analyzed. The instrument will display the measured Relative mV value on the LCD, together with a short GLP information about the last calibration or Offset: 0.0 mV no Rel mV calibration was performed.

Notes: If the ORP sensor is not in solution or the measured mV potential is out of range, “—” will be displayed on the LCD.

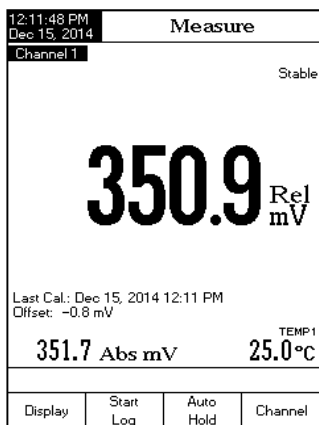
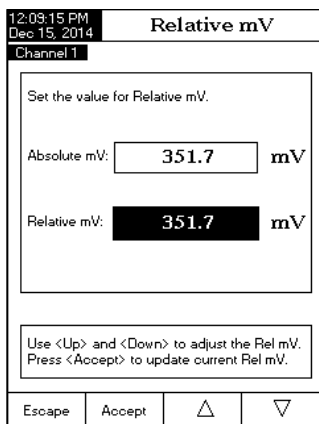

For greater accuracy, it is recommended to calibrate the ISE sensors frequently. The instrument should be recalibrated when "ISE x Calibration Expired" (the "x" represents channel "1" or channel "2") message appears on the LCD, in the Reminder messages area.

Due to electrode conditioning time, the electrode must be kept immersed a few seconds to stabilize. The user will be guided step by step during calibration with easy-to-follow messages on the display. This will make the calibration a simple and error-free procedure.

PREPARATION

Pour small quantities of the standard solutions into clean beakers. If possible, use plastic beakers to minimize any EMC interferences.

For accurate calibration and to minimize cross-contamination, use two beakers for each standard solution. One for rinsing the electrode and one for calibration.

Note: To read concentration (not activity) ISA must be added to the standards and samples. No corrections are needed due to dilutions.

CALIBRATION PROCEDURE

The ISE calibration and measurement can be performed with or without temperature compensation. If the temperature compensation option is enabled, the isopotential point of the electrode must be set in ISE Setup in order to perform correct concentration measurements.

Before calibrating, make sure that the appropriate Electrode Type has been selected in ISE Setup according to the measured Ion/compound.

ISE Calibration screen description

The screenshot shows the ISE Calibration screen with the following elements and labels:

- Time and Date:** 03:26:38 PM, Dec 15, 2014
- Title:** ISE Calibration
- Channel:** Channel 1
- Measured concentration:** 10100 mg/L (Stable)
- ISE:** ISE: Sodium
- Calibration Standard:** 371.2 mV (10000)
- Temperature:** 22.3°C (ATC1)
- Calibrated Standards:** E-2, 1.00, 10.0, 100, 1000
- Last Calibration:** Dec 15, 2014 03:25 PM
- Calibration messages:** Press <Accept> to update calibration.
- Navigation Buttons:** Escape, Accept, Next Standard, Previous Standard

The group of calibration standards is set under ISE Setup → Calibration. Select standards that are in the measurement range of the samples.

To calibrate the instrument:

- Press **CAL**. If the instrument was calibrated before and calibration was not cleared, the old calibration can be cleared by pressing **Clear Cal**. After 10 seconds, **Clear Cal** will no longer be available.

Note: It is very important to clear calibration history when a new electrode is used because most errors and warning messages that appear during calibration depend on calibration history.

- Add ISA to both standard solutions and samples.
- Immerse the Ion Selective Electrode and the temperature probe approximately 2 cm (1") into the less concentrated standard solution and stir gently.
- Select the appropriate standard solution concentration with **Next Standard** or **Previous Standard**. For **All Standards** manual entry mode, the standard concentration can be selected from a list containing all the predefined and custom standards. For **Group Standard** manual entry mode the standard concentration can be selected from the predefined group of standards. Press **Accept** to calibrate the electrode in the standard.

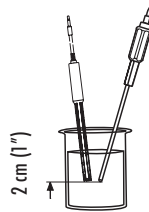

*Note: To adjust standard value: Press **SETUP**. A pop-up menu will be displayed on the LCD in which the concentration value can be adjusted using **Δ** or **∇**. Press **Accept** to save the new concentration value.*

- The "Please wait..." message will appear on the LCD for 10 seconds. Remove ISE from first standard, rinse tip and immerse the Ion selective electrode and the temperature probe into the next standard solution and follow the above procedure or press **Escape** to exit calibration.

Notes: The new added calibration point will replace an old one if the difference between them is less than 20 % of the standard solution.

*If the existing stored calibration is full (five calibration points), a pop-up menu will be displayed on the LCD in which you can select with **<** or **>** the standard solution you want to replace with the current one.*

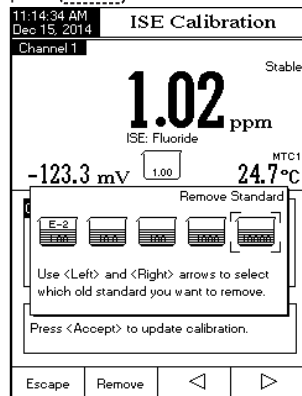

Press to delete the selected calibrated point and then press to update calibration with the new standard solution.

If the isopotential point of the electrode is unknown, the ISE calibration and measurements can be performed without temperature compensation (see ISE Setup, Temperature option for details).

When in MTC mode, after selecting a standard press , a pop-up menu will be displayed on the LCD in which the concentration and the temperature value can be adjusted by pressing and then or keys. Press to save the modified value and then / to select next/previous value to be adjusted. MTC value will have no effect on measurement but will be included on log data.

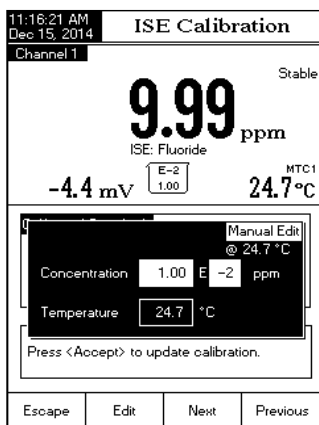

CALIBRATION MESSAGES

- **Wrong standard solution. Check the standard solution:** this message appears when the difference between the reading and the value of the selected standard solution concentration is significant. If this message is displayed, check if you have selected the appropriate calibration standard.
- **Standard too close. Check the standard or clear calibration:** this message appears when the difference between current ISE standard and the already calibrated standard is too low.
- **Slope too low/high. Check the standard solution.** Recalibrate using fresh standards.
- **Difference between standards temperature is too high.** Press to update calibration or clear old calibration.

Make sure the instrument and ISE sensor have been calibrated before making ISE measurements. When using one of the incremental methods for measurement, at least a two point ISE calibration must be performed to establish the electrode slope.

For accurate measurements, add the appropriate ISA (Ionic Strength Adjuster) to both samples and standards. Consult ISE manual for sensor preparation details.

DIRECT MEASUREMENT

To measure the concentration of a sample using the Direct reading mode:

- Press **MODE** and then **ISE** to select ISE Measure mode for the selected channel.
- Select the Direct reading mode (see ISE Setup for details).
- Add ISA to the sample solution.
- Submerge the Ion Selective Electrode tip and the temperature probe approximately 2 cm (1") into the sample. Allow time for the electrode to stabilize.
- The measured concentration value will be displayed on the LCD in the selected units.

Note: If the reading is out of range, "--" will be displayed on the LCD.

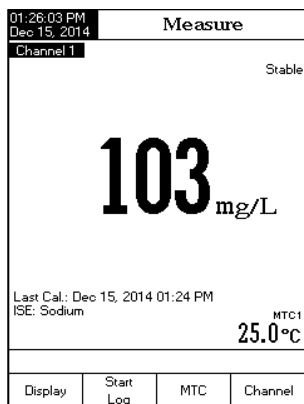

DIRECT/AUTOHOLD MEASUREMENT

To measure the concentration of a sample using the Direct/AutoHold reading mode:

- Press **MODE** and then **ISE** to select ISE Measure mode for the selected channel.
- Select the Direct/AutoHold reading mode (see ISE Setup for details).
- Add ISA to the sample solution.
- Dip the Ion Selective Electrode tip and the temperature probe approximately 2 cm (1") into the sample to be tested.

- The measured concentration value will be displayed on the LCD. Press **Auto Hold** the "AutoHold" indicator will blink on the LCD until the stability criterion is reached. The concentration value will be frozen on the LCD, along with "AutoHold" indicator.

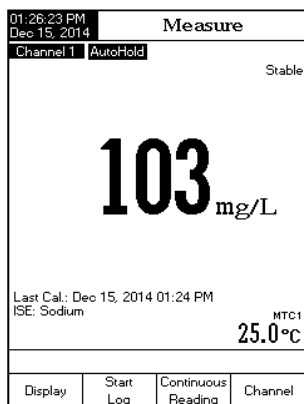

- To return to normal Measure mode press Continuous Reading

Note: If the reading is out of range, “—” will be displayed on the LCD.

KNOWN ADDITION

To measure the concentration of a sample using the Known Addition incremental method:

- Press MODE and then ISE to select ISE Measure mode for the selected channel.
- Select the Known Addition method (see ISE Setup for details).
- Prior to starting a KA procedure, the ISE sensor must be calibrated with a minimum of two standards containing ISA. The slope of the electrode will be used in all calculations involved in KA.
- If following an established procedure: Press KA Edit the method variables and follow the procedure below.

- Press Edit to set the method parameters. Press Next / Previous to select next/previous parameter to edit, then press Edit and use Δ or ▽ to set the desired parameter value. Press Accept to save the modified value and then press Escape to exit method parameters edit menu.

- If developing a procedure: Before attempting Known Addition analysis it is important to determine what sample volume, standard concentration and standard volume will produce the best results. As a general rule, the addition of standard should change the mV value of the sample by 15 - 20 mV. For a positively charged ion (i.e. Sodium, Potassium, Calcium), the standard addition should increase the mV. For a negatively charged ion (i.e. Sulfide, Fluoride, Chloride), the standard addition should decrease the mV. Start with a small trial. For example: Measure 50 mL of sample, add a magnetic stir bar, place on a stirrer, add ISA (consult ISE manual) and place ISE electrode tip into the sample. Put instrument in mV mode and record the observed mV. Using a micropipette, add a volume of the highest ISE standard available (i.e. 0.1M or 1000 ppm).

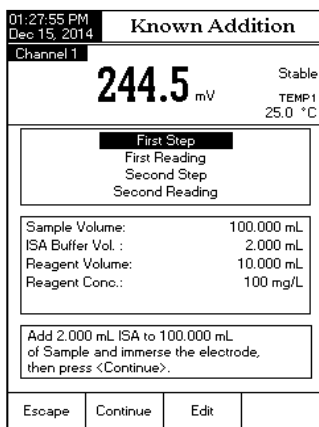
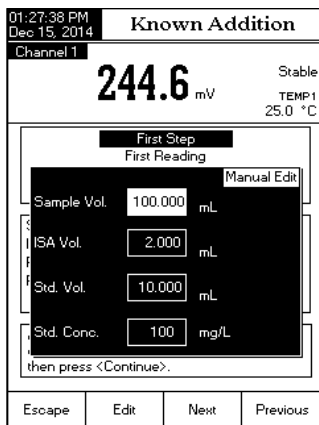

Start by adding 500 μL at a time (for example). Watch the change in mV. When you have observed approximately a 15 mV change from the original sample, calculate the total volume added. Adjust sample and standard volumes proportionally to standard volumes that can be measured with accuracy. Use volumetric pipettes for standard, ISA and sample addition.

- Press **KA**: Edit the procedure variables to the volumes determined in the prior step.

Procedure:

- Press **KA** to enter Known Addition mode.
- Volumetrically add sample to a clean beaker. Add a magnetic stir bar and place on a stir plate. Stir sample. The method will prompt user to add ISA. Place ISE sensor tip into the solution and a mV value will show on the display.
- Press **Continue** to take the first mV reading.
- When the reading is stable, press **Read** to store the first mV reading. The second step of the method will be displayed on the LCD in which the user is notified to add the Volume of Standard to the sample.
- Press **Continue** to take the second mV reading.
- When the reading is stable, press **Read** to store the second mV reading. The ISE measurement results will be displayed on the LCD.
- Press **Save** to log the current results into a ISE Method Report. Press **Direct Measure** to return to ISE Measure mode. Press **Start KA** to measure additional samples. Rinse ISE sample between samples.
- Press **Edit** to modify the method parameters.

*Note: Press **Escape** at any time to stop the measurement and return to ISE Measure mode.*

01:28:39 PM Dec. 15, 2014		ISE Results	
Channel 1		102 mg/L	
Sample ID:		Calculated Slope:	98.2 %
Reading 1:	244.5 mV	Reading 2:	244.5 mV
Sample Volume:	100.000 mL	Reagent Volume:	10.000 mL
ISA Volume:	2.000 mL	Reagent Conc.:	100 mg/L
Press <Direct Measure> to return in main measurement panel. Press <Save> to log the current results.			
Direct Measure	Save	Edit	Start KA

KNOWN SUBTRACTION

To measure the concentration of a sample using the Known Subtraction method:

- Press **MODE** and then **ISE** to select **ISE Measure** mode for the selected channel.
- Select the Known Subtraction method (see ISE Setup → Reading Mode).
- Prior to starting a KS procedure, the ISE sensor must be calibrated with a minimum of two standards containing ISA. The slope of the electrode will be used in all calculations involved in KS.

- If following an established procedure: Press **KS** then edit the method variables and follow the procedure below.
- Press **Edit** to set the method parameters. Press **Next** / **Previous** to select next/previous parameter to edit, then press **Edit** and use **Δ** or **▽** to set the desired parameter value. Press **Accept** to save the modified value and then press **Escape** to exit method parameters edit menu.
- If developing a procedure: Before attempting Known Subtraction analysis it is important to determine what sample volume, standard reactant concentration and standard volume will produce the best results and the way the reagent will react with the measured ion on a molar basis (stoichiometric factor). As a general rule, the addition of standard should change the mV value of the sample by 15-20 mV.

For a positively charged ion (i.e. Calcium), the reactant addition should decrease the mV. For a negatively charged ion (i.e. Sulfide, Fluoride, Chloride), the reactant addition should increase the mV. Start with a small trial. For example: Measure 50 mL of sample, add a magnetic stir bar, place on a stirrer, add ISA (consult ISE manual) and place ISE electrode tip in to the sample. Put instrument in mV mode and record the observed mV. Using a micropipette, add a volume of the reactant standard. Start by adding 500 μL at a time (for example). Watch the change in mV. When you have observed approximately a 15 mV change from the original sample, calculate the total volume added. Adjust sample and standard volumes proportionally to standard volumes that can be measured with accuracy. Use volumetric pipettes for standard, ISA and reagent addition.

- Press **KS** then edit the procedure variables to the volumes determined in the prior step.

Procedure:

- Press **KS** to enter Known Subtraction mode.
- Volumetrically add sample to a clean beaker. Add a magnetic stir bar and place on a stir plate. Stir sample. The method will prompt user to add ISA. Place ISE sensor tip into the solution and a mV value will show on the display.
- Press **Continue** to take the first mV reading.
- When the reading is stable, press **Read** to store the first mV reading. The second step of the method will be displayed on the LCD in which the user is notified to add the volume of reagent to the sample.
- Press **Continue** to take the second mV reading.

- When the reading is stable, press **Read** to store the second mV reading. The ISE measurement results will be displayed on the LCD.
- Press **Save** to log the current results into an ISE Method Report. Press **Direct Measure** to return to ISE Measure mode. Press **Start KS** to start another measurement. Rinse ISE sensor between samples.
- Press **Edit** to modify parameters.
*Note: Press **Escape** at any time to stop the measurement and return to ISE Measure mode.*

ANALYTE ADDITION

To measure the concentration of a sample using Analyte Addition method:

- Press **MODE** and then **ISE** to select **ISE Measure** mode for the selected channel.
- Select the Analyte Addition method (see ISE Setup → Reading Mode).
- Prior to starting an AA procedure, the ISE sensor must be calibrated with a minimum of two standards containing ISA. The slope of the electrode will be used in all calculations involved in AA.
- If following an established procedure: Press **AA** then edit the method variables and follow the procedure below.
- Press **Edit** to set the method parameters. Press **Next** / **Previous** to select next/previous parameter to edit, then press **Edit** and use **Δ** or **∇** to set the desired parameter value. Press **Accept** to save the modified value and then press **Escape** to exit method parameters edit menu.
- If developing a procedure: Before attempting Analyte Addition analysis, it is important to determine which standard volume, concentration and sample size will produce the best results. As a general rule, the standard must be less concentrated than the sample so the addition of sample will increase the total ion content of the solution from the beaker and change the mV value by at least 10 mV. For a positively charged ion (i.e. Sodium), the AA increases the mV. For a negatively charged ion (i.e. Sulfide, Fluoride, Chloride), the AA should decrease the mV. Start with a small trial. For example: Measure 50 mL of standard, add a magnetic stir bar and place on a stirrer, add ISA (consult ISE manual) and place ISE electrode tip into the sample. Put instrument in mV mode and record the observed mV. Using a micropipette, add a volume of the sample. Start by adding 500 μ L at a time (for example). Watch the change in mV. When you have observed approximately a 10 mV change from the original standard, calculate the total volume added. Adjust sample and standard volumes proportionally to standard volumes that can be measured with accuracy. Use volumetric pipettes for standard, ISA and sample addition.

- Press **AA** then edit the procedure variables to the volumes determined in the prior step.

Procedure:

- Press **AA** to enter Analyte Addition mode.
- Volumetrically add standard to a clean beaker. Add a magnetic stir bar and place on a stir plate. Stir standard. The method will prompt user to add ISA. Place ISE sensor tip into the solution and a mV value will show on the display.
- Press **Continue** to take the first mV reading.
- When the reading is stable, press **Read** to store the first mV reading. The second step of the method will be displayed on the LCD, in which the user is notified to add the Sample Volume to the standard solution. The method parameters are also displayed on the LCD.
- Press **Continue** to take the second mV reading.
- When the reading is stable, press **Read** to store the second mV reading. The ISE measurement results will be displayed on the LCD.
- Press **Save** to log the current results into an ISE Method Report. Press **Direct Measure** to return to **ISE Measure** mode.
- Press **Start AA** to start another measurement. Rinse ISE sensor between samples.
- Press **Edit** to modify the method parameters.

*Note: Press **Escape** at any time to stop the measurement and return to ISE Measure mode.*

ANALYTE SUBTRACTION

To measure the concentration of a sample using Analyte Subtraction method:

- Press **MODE** and then **ISE** to select **ISE Measure** mode for the selected channel.
- Select the Analyte Subtraction method (see ISE Setup → Reading Mode).
- Prior to starting an AS procedure, the ISE sensor must be calibrated with a minimum of two standards containing ISA. The slope of the electrode will be used in all calculations involved in AS.
- If following an established procedure: Press **AS** then edit the method variables and follow the procedure below.
- Press **Edit** to set the method parameters. Press **Next** / **Previous** to select next/previous parameter to edit, then press **Edit** and use **Δ** or **∇** to set the desired parameter value. Press **Accept** to save the modified value and then press **Escape** to exit method parameters edit menu.

- If developing a procedure: Before attempting Analyte Subtraction analysis, it is important to determine which sample volume, reactant volume and concentration, will produce the best results and the way the reagent will react with the measured ion on a molar basis (stoichiometric factor). As a general rule, the reactant should contain the measured ion so the sample addition will react with the ion and reduce the measured concentration of the sample. The change of the mV value, before and after the sample addition, should be at least 10 mV. Start with a small trial. For example: Measure 50 mL of reactant, add a magnetic stir bar and place on a stirrer, add ISA (consult ISE manual) and place ISE electrode tip into the sample. Put instrument in mV mode and record the observed mV. Using a micropipette, add a volume of the sample. Start by adding 500 μL at a time (for example). Watch the change in mV. When you have observed approximately a 10 mV change from the original value, calculate the total volume added. Adjust sample and standard volumes proportionally to standard volumes that can be measured with accuracy. Use volumetric pipettes for standard, ISA and sample addition.
- Press then edit the procedure variables to the volumes determined in the prior step.

Procedure:

- Press to enter Analyte Subtraction mode.
- Volumetrically add reactant to a clean beaker. Add a magnetic stir bar and place on a stir plate. Stir standard. The method will prompt user to add ISA. Place ISE sensor tip into the solution and a mV value will show on the display.
- Press to take the first mV reading.
- When the reading is stable, press to store the first mV reading. The second step of the method will be displayed on the LCD in which the user is notified to add the Sample Volume to the standard solution.
- Press to take the second mV reading.
- When the reading is stable, press to store the second mV reading. The ISE measurement results will be displayed on the LCD.
- Press to log the current results into an ISE Method Report. Press to return to ISE Measure mode. Press to start another measurement. Rinse sensor between samples.
- Press to modify the method parameters.

Note: Press at any time to stop the measurement and return to ISE Measure mode.

The user temperature calibration menu can be accessed during meter startup by simultaneously pressing three keys as shown in the drawing below. Press the keys after the short beep is heard at the meter power on. Keep all three keys pressed until Temp. Calibration menu appears.

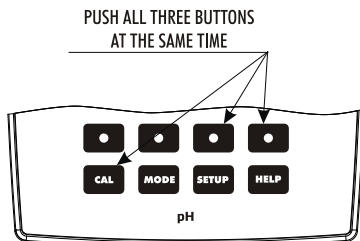

Note: The user temperature calibration is performed at three points: around 0 °C, 50 °C and 100 °C.

To perform the user temperature calibration:

- Select the desired temperature channel by pressing Channel (**HI5222** only).
- Press Start User Calib to start the temperature calibration. Adjust the temperature preset value using Δ or ▽ when necessary.
- Insert the temperature probe into the beaker with water at 0 °C.
- Wait for measurement to stabilize and then press Accept to confirm the calibration point.
- Repeat the previous steps for 50 °C and 100 °C.
- Save the calibration.
- Press Escape to return to measure mode.

Note: Press Clear User Calib if you want to clear the temperature user calibration.

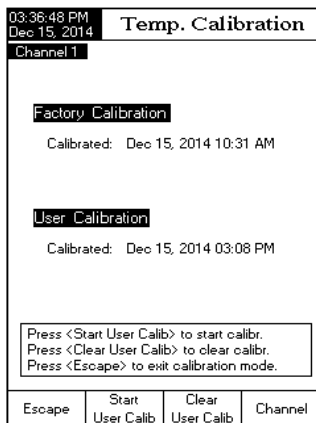

There are 5 ways the Reading Mode and Log may be configured together. The table below shows the combinations and indicates where the completed log will be stored.

Reading Mode	Log	log Recall
Direct	Automatic (1)	Automatic Log
	Manual (2)	Manual Log
	Auto Hold (NA)	Not Applicable
Direct/Auto-Hold	Automatic (3)	Automatic Log
	Manual (4)	Manual Log
	Auto Hold (5)	Manual Log

1) Direct Reading Mode and Automatic Log:

Real time continuous measurements are on display with continuous logging to meter memory. Press .

02:18:45 PM Dec 15, 2014		Measure	
Channel 1		102 mg/L	Stable
Last Cal.: Dec 15, 2014 01:24 PM ISE: Sodium		MTC1	25.0°C
Channel 2		233.8 mV	Stable
		TEMP2	25.0°C
Display	Start Log1	MTC	Channel

2) Direct Reading Mode and Manual Log:

Real time continuous measurements are on display and snapshots of measurement data are stored in the Manual log when the user presses **Log**. Subsequent snapshots will be added to the same Manual Lot every time the **Log** is depressed unless **New Lot** is selected under Log options.

*Note: When the **Log** is pressed the lot ID along with the current record number will appear for short time on the selected channel window on the top/left corner (e.g. L033_MV 8 - this means lot ID L033_mV and record number 8).*



3) Direct/AutoHold Reading Mode and Automatic Log

Press **Start Log** and then **Auto Hold** keys must be pressed on front display to initiate this function. Real time continuous measurements are on display with "AutoHold" flashing and real time continuous logging into meter memory, until the meter reaches the stability criteria to go into AutoHold mode. The stored sample logs will be marked with an "H" to indicate the AutoHold mode. The virtual key **Continuous Reading** returns operation to real time continuous measurements and **Stop Log** stops the logging session.

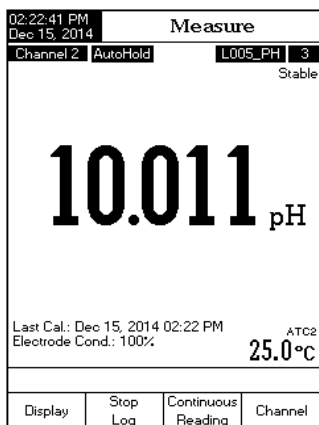

4) Direct/AutoHold Reading Mode and Manual Log

Press **Log** in order to add one new record in the log report. The manual log is working even if it is in AutoHold or Continuous Reading mode. Press **Auto Hold** to initiate the AutoHold event. "AutoHold" will flash until the stability criteria is reached and then the screen freezes in Auto Hold mode, the data is marked with an "H".

5) Direct/AutoHold Reading Mode and Auto Hold Log

Press **Start Log** and then **Auto Hold** keys initiate and automate the capture of stable data which is stored in the Recall Manual Log file. During the process, “AutoHold” will flash until the stability criteria is reached and then the screen freezes in AutoHold mode, the data is logged and marked with an “H”. The virtual key **Continuous Reading** returns operation to Real time continuous measurement. Press **Auto Hold** again to log a second stable data point. The lot ID along with the record index will appear for short time on the top/left corner on the selected channel window, every time a record will be added to the lot.

LOG RECALL

This feature allows the user to view all stored data. If no data was logged, the “No records were found” message will be displayed on the LCD in the Log Recall screen. Otherwise, the instrument will display all the memorized lots in accordance with the selected option: Automatic Log, Manual Log or ISE Method Report (HI5222 only).

To view the memorized data:

- Press **SETUP** while in **Measure** mode.
- Press **Log Recall**. The “Choose Log Report Type” message will be displayed in the Reminder messages area.
- Press **Automatic Log**, **Manual Log** or **ISE Method Report** to select the desired Log Report type. All logged lots for the selected Log Report type will be displayed on the LCD.
- To filter the displayed lots, press **MODE** and then the desired parameter **pH**, **mV** or **ISE** -HI5222 only. Only the selected measurement parameter lots will be displayed on the LCD.

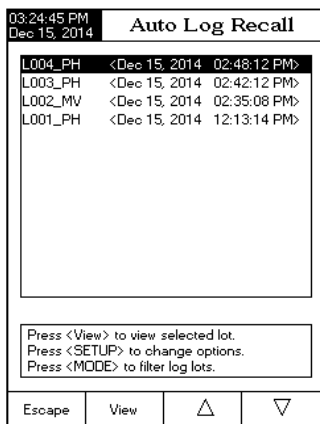
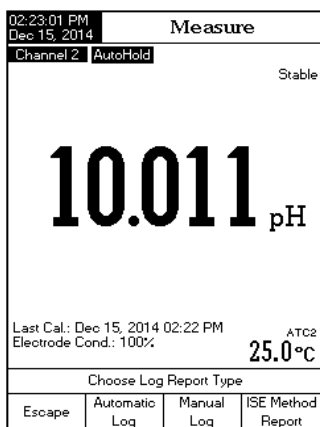

- Select the desired lot with △ or ▽ and press View to display the logged data from the highlighted lot. The “Please wait...” message will be displayed on the LCD for one second. The selected Logging Data Configuration options will be displayed on the LCD, together with GLP information (last calibration date and calibrated buffers/standards) if a calibration has been performed on the selected mode and the logged values (measured value, mV value, temperature value, temperature compensation mode and the logging time).

03:25:01 PM Dec 15, 2014		Log Report			
Log Lot:		L004_PH / Channel 2			
Log Type:		Automatic			
Company Name:					
Date & Time:		Dec 15, 2014 02:48:12 PM			
Instrument ID:					
Operator ID:					
Sample ID:		005			
Additional Info 1:					
Additional Info 2:					
Last Calibration:		Dec 15, 2014 02:47PM			
Calibrated Buffers					
Index	pH	mV	Slope(%)	Temp(°C)	Src
1.	4.010	168.6	37.3	25.0	A
	Hanna	Dec 15, 2014	02:46:43PM		
2.	7.010	-5.2	37.0	25.0	A
	Hanna	Dec 15, 2014	02:45:27PM		
3.	10.010	-177.4	37.0	25.0	A
	Hanna	Dec 15, 2014	02:47:46PM		
Index	pH	mV	Temp(°C)	Time	
1	3.787	-164.6	25.0 A	02:48:12PM	
2	3.787	-164.6	25.0 A	02:48:13PM	
3	3.787	-164.6	25.0 A	02:48:14PM	
Escape		View Graph		△	▽

Note: For automatic logging only, it is possible to view the plotted graph.

Press View Graph to display the graph.

By pressing Shift Axes it is possible to move the graph along the X or Y axis with the arrow keys. If pressing SETUP while the graph is displayed, the zoom menu for the X and Y axes will be accessed.

Press Zoom Time or Zoom pH / Zoom mV / Zoom Ret.mV / Zoom Ion to switch between the active zooming axes and then zoom in or out on the selected axis by pressing the appropriate virtual key.

- Press Escape to return to the previous menu at any time.

03:25:01 PM Dec 15, 2014		Log Report			
Log Lot:		L004_PH / Channel 2			
Log Type:		Automatic			
Company Name:					
Date & Time:		Dec 15, 2014 02:48:12 PM			
Instrument ID:					
Operator ID:					
Sample ID:		005			
Additional Info 1:					
Additional Info 2:					
Last Calibration:		Dec 15, 2014 02:47PM			
Calibrated Buffers					
Index	pH	mV	Slope(%)	Temp(°C)	Src
1.	4.010	168.6	37.3	25.0	A
	Hanna	Dec 15, 2014	02:46:43PM		
2.	7.010	-5.2	37.0	25.0	A
	Hanna	Dec 15, 2014	02:45:27PM		
3.	10.010	-177.4	37.0	25.0	A
	Hanna	Dec 15, 2014	02:47:46PM		
Index	pH	mV	Temp(°C)	Time	
1	3.787	-164.6	25.0 A	02:48:12PM	
2	3.787	-164.6	25.0 A	02:48:13PM	
3	3.787	-164.6	25.0 A	02:48:14PM	
Escape		View Graph		△	▽

To delete lots:

- Press **SETUP** while in **Log Recall** mode.
- Press **Delete** or **Delete All** to access delete or delete all mode. Otherwise, press **View** to return to **Log Recall** view mode.
- After selecting one of the deleting modes, use **Δ** or **▽** to select one lot and then press **Delete** or **Delete All** to delete the selected lot or all lots. The “Please wait...” message will be displayed on the LCD until the selected lot or all lots are deleted.
- Press **SETUP** and then press **View** to exit deleting mode and return to **Log Recall** view mode.
- Press **Escape** to exit **Log Recall** mode and return to **Measure** mode.

Note: Logged lots should also be deleted whenever “Please Delete Old Log Files” or “Low Data Logging Space” message appears on the LCD, in the Reminder messages area.

03:26:12 PM Dec 15, 2014		Auto Log Recall
L004_PH	<Dec 15, 2014 02:48:12 PM>	
L003_PH	<Dec 15, 2014 02:42:12 PM>	
L002_MW	<Dec 15, 2014 02:35:08 PM>	
L001_PH	<Dec 15, 2014 12:13:14 PM>	
Press <View> to select view mode. Press <Delete> for delete mode. Press <Delete All> for delete all mode.		
	View	Delete Delete All

Data transmission from the instrument to the PC can be done with the **HI92000** Windows® compatible software (optional). **HI92000** also offers graphing and on-line help features.

Data logged on the **HI5221** and **HI5222** meters can be exported to the most popular spreadsheet programs for further analysis.

HI5221 and **HI5222** instruments have an USB interface available.

Use a standard USB cable to connect your instrument to the PC.

Make sure that the instrument and the **HI92000** software have the same baud rate and the appropriate communication port.

The PC software may also be used for real time logging.

ISE THEORY

An Ion Selective Electrode (ISE) is an electrochemical sensor that changes voltage with the activity or concentration of ions in solutions. The change in voltage is a logarithmic relationship with concentration, and is expressed by the Nernst equation:

$$E = E^{\circ} + S \log(a)$$

where: E - the measured voltage;
 E° - standard voltage and other standard system voltages;
 a - the activity of the ion being measured;

$$S = \frac{2.303RT}{nF}$$

S - the Nernst slope factor and is derived from thermodynamic principles;
 R - the universal gas constant (8.314 J/(K·mol));
 T - the temperature in degrees Kelvin;
 F - the Faraday's constant (96,485 C/mol);
 n - the ion charge.

The slope may be positive or negative depending upon the Ion charge (n).

SPECIES	SLOPE (mV/decade)
Monovalent cation	+59.16
Monovalent anion	-59.16
Divalent cation	+29.58
Divalent anion	-29.58

Activity and concentration are related by an "activity coefficient", expressed as:

$$a = \gamma \cdot C$$

where: a - the activity of the ion being measured;
 γ - the activity coefficient;
 C - the concentration of the ion being measured.

In very dilute solutions γ approaches 1 so activity and concentration are the same.

Actual samples that are more concentrated have much smaller activity coefficients ($\gamma < 1$). The addition of an inert background salt to standards and samples stabilizes the activity coefficient so that concentration measurements may be made directly. Some of Hanna's Ionic Strength Adjuster formulations also may optimize pH and complex interferences, in addition to standardizing the ionic strength.

The Nernst equation can be written:

$$E = E^o + S \log(C)$$

ION SELECTIVE ANALYSIS METHODS

Direct Analysis

This method is a simple procedure for measuring multiple samples. It should only be used in the linear working regions of the sensor. A direct reading instrument such as the [HI5222](#) determines concentration of the unknown by a direct reading after calibrating the instrument with the standards. The instrument is calibrated as described in "ISE CALIBRATION & MEASUREMENTS" section, with two or more freshly made standards that are in the measurement range of the unknowns. Ionic strength adjustment is made to samples and standards. Unknowns are measured directly by the instrument. At lower concentrations, in non-linear regions of the electrode response, multiple calibration points will extend measurements to a practical detection limit. Calibrations must be performed more frequently in these cases.

Incremental Methods

Incremental methods are useful for the measurement of samples whose constituents are variable or concentrated. Incremental techniques can reduce errors from such variables as temperature, viscosity, or pH extremes and will provide indirect analysis of ions for which there is no ISE sensor for a direct measurement. There are four commonly used different incremental methods for sample measurement. They are Known Addition, Known Subtraction, Analyte Addition and Analyte Subtraction. [HI5222](#) allows the analyst to use these techniques as a simple routine procedure, thus eliminating calculations or tables. The method once set up can be used for repetitive measurements on multiple samples.

Known Addition and Known Subtraction

With Known addition, **standard is added** to a sample being measured. The standard and sample contain the same ion. mV are taken before and after the standard addition. From the change in mV, the sample concentration is determined.

$$C_{SAMP} = \frac{C_{STD} \cdot V_{STD} \cdot (V_{SAMP} + V_{ISA})}{(V_{SAMP} + V_{STD} + V_{ISA}) \cdot 10^{\frac{\Delta E}{S}} \cdot V_{SAMP}}$$

With Known subtraction, a known standard is added to an ionic sample being measured. The standard reacts with the measured ion in the sample in a known manner, thus removing measured ions from the solution. From the change in mV, the concentration of the sample is determined.

$$C_{SAMP} = \frac{C_{STD} \cdot V_{STD} \cdot f \cdot (V_{SAMP} + V_{ISA})}{(V_{SAMP} + V_{ISA}) - (V_{SAMP} + V_{STD} + V_{ISA}) \cdot 10^{\frac{\Delta E}{S}} \cdot V_{SAMP}}$$

where: C_{SAMP} - the sample concentration; ΔE - the difference of potential from the electrode;
 C_{STD} - the standard concentration; S - the electrode slope, determined in a previous calibration;
 V_{SAMP} - the sample volume; f - the stoichiometric ratio between sample and standard;
 V_{STD} - the standard volume;
 V_{ISA} - ISA volume

Example 1

You have sulfide samples and you are adding Ag^+ . The reaction is:

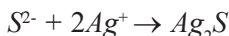

One mole sulfide sample reacts with 2 moles silver standard ($f = 1/2$).

Example 2

You have sulfide samples and you are adding Pb^{2+} . The reaction is:

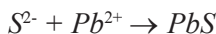

One mole sulfide sample reacts with 1 mole lead standard ($f = 1$).

Analyte Addition and Analyte Subtraction

Analyte Addition and Subtraction are variations of the previous two methods.

With Analyte Addition, **sample (analyte) is added** to an ion standard being measured. The standard and sample contain the same ion. mV are taken before and after the sample addition. From the mV the analyte concentration is determined.

$$C_{SAMP} = \frac{C_{STD} \cdot V_{STD}}{(V_{STD} + V_{ISA})} \cdot \frac{(V_{STD} + V_{SAMP} + V_{ISA}) \cdot 10^{\frac{\Delta E}{S}} - (V_{STD} + V_{ISA})}{V_{SAMP}}$$

With Analyte Subtraction, **sample (analyte) is added to an ion standard** being measured. The analyte reacts with the measured ion in a known manner thus removing measured ions from the solution. From the change in mV the concentration of the analyte is determined.

$$C_{SAMP} = f \cdot \left\{ \frac{(V_{STD} + V_{ISA})}{V_{SAMP}} - \left[1 + \frac{(V_{STD} + V_{ISA})}{V_{SAMP}} \right] \cdot 10^{\frac{\Delta E}{S}} \right\} \cdot \left(\frac{C_{STD} \cdot V_{STD}}{V_{STD} + V_{ISA}} \right)$$

where: C_{SAMP} - the sample concentration; ΔE - the difference of potential from the electrode;
 C_{STD} - the standard concentration; S - the electrode slope, determined in a previous calibration;
 V_{SAMP} - the sample volume;
 V_{STD} - the standard volume; f - the stoichiometric ratio between sample and standard;
 V_{ISA} - ISA volume;

Temperature has an effect on pH. The calibration buffer solutions are affected by temperature changes to a lower degree than normal solutions.

During calibration the instrument will automatically calibrate to the pH value corresponding to the measured or set temperature.

TEMP			pH BUFFERS								
°C	K	°F	1.679	3.000	4.010	6.862	7.010	9.177	10.010	12.454	
0	273	32	1.670	3.072	4.007	6.982	7.130	9.459	10.316	13.379	
5	278	41	1.670	3.051	4.002	6.949	7.098	9.391	10.245	13.178	
10	283	50	1.671	3.033	4.000	6.921	7.070	9.328	10.180	12.985	
15	288	59	1.673	3.019	4.001	6.897	7.046	9.273	10.118	12.799	
20	293	68	1.675	3.008	4.004	6.878	7.027	9.222	10.062	12.621	
25	298	77	1.679	3.000	4.010	6.862	7.010	9.177	10.010	12.450	
30	303	86	1.683	2.995	4.017	6.851	6.998	9.137	9.962	12.286	
35	308	95	1.688	2.991	4.026	6.842	6.989	9.108	9.919	12.128	
40	313	104	1.693	2.990	4.037	6.837	6.983	9.069	9.881	11.978	
45	318	113	1.700	2.990	4.049	6.834	6.979	9.040	9.847	11.834	
50	323	122	1.707	2.991	4.062	6.834	6.978	9.014	9.817	11.697	
55	328	131	1.715	2.993	4.076	6.836	6.979	8.990	9.793	11.566	
60	333	140	1.724	2.995	4.091	6.839	6.982	8.969	9.773	11.442	
65	338	149	1.734	2.998	4.107	6.844	6.987	8.948	9.757	11.323	
70	343	158	1.744	3.000	4.123	6.850	6.993	8.929	9.746	11.211	
75	348	167	1.755	3.002	4.139	6.857	7.001	8.910	9.740	11.104	
80	353	176	1.767	3.003	4.156	6.865	7.010	8.891	9.738	11.003	
85	358	185	1.780	3.002	4.172	6.873	7.019	8.871	9.740	10.908	
90	363	194	1.793	3.000	4.187	6.880	7.029	8.851	9.748	10.819	
95	368	203	1.807	2.996	4.202	6.888	7.040	8.829	9.759	10.734	

During calibration the instrument will display the pH buffer value at 25 °C.

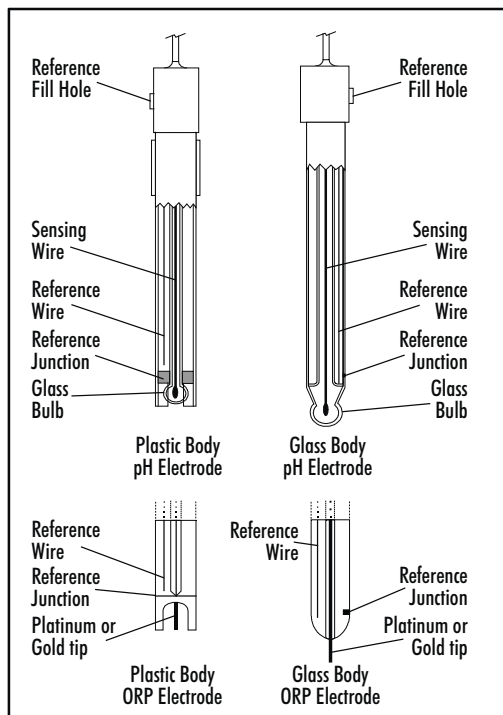

PREPARATION PROCEDURE

Remove the protective cap off the pH electrode.

SALT DEPOSITS MAY BE PRESENT. This is normal with electrodes. They will disappear when rinsed with water.

During transport, tiny bubbles of air may form inside the glass bulb affecting proper functioning of the electrode. These bubbles can be removed by “shaking down” the electrode as you would do with a glass thermometer.

If the bulb and/or junction is dry, soak the electrode in [HI70300](#) or [HI80300](#) Storage Solution for at least one hour.

For refillable electrodes:

If the filling solution (electrolyte) is more than 2 cm (1”) below the fill hole, add [HI7082](#) or [HI8082](#) 3.5M KCl Electrolyte Solution for double junction or [HI7071](#) or [HI8071](#) 3.5M KCl + AgCl Electrolyte Solution for single junction electrodes.

Unscrew the fill hole screw during measurements. This will allow electrolyte to flow out of the junction.

For AmpHel® electrodes:

If the electrode does not respond to pH changes, the battery may have run down and the electrode or battery (if replaceable) should be replaced.

MEASURE

Rinse the pH electrode tip with distilled water. Immerse the tip bottom 4 cm (1.5") in the sample and stir gently for a few seconds.

For a faster response and to avoid cross-contamination of the samples, rinse the electrode tip with a few drops of the solution to be tested, before taking measurements.

STORAGE PROCEDURE

To minimize clogging and ensure a quick response time, the glass bulb and the junction of pH electrode should be kept moist and not allowed to dry out.

Replace the solution in the protective cap with a few drops of [HI70300](#) or [HI80300](#) Storage Solution or, in its absence, Filling Solution ([HI7071](#) or [HI8071](#) for single junction and [HI7082](#) or [HI8082](#) for double junction electrodes). Follow the Preparation Procedure before taking measurements.

Note: NEVER STORE THE ELECTRODE IN DISTILLED OR DEIONIZED WATER.

PERIODIC MAINTENANCE

Inspect the electrode and the cable. The cable used for connection to the instrument must be intact and there must be no points of broken insulation on the cable or cracks on the electrode stem or bulb. Connectors must be perfectly clean and dry.

If any scratches or cracks are present, replace the electrode. Rinse off any salt deposits with water.

pH PROBE MAINTENANCE**For refillable electrodes:**

Refill the reference chamber with fresh electrolyte ([HI7071](#) or [HI8071](#) for single junction or [HI7082](#) or [HI8082](#) for double junction electrodes). Allow the electrode to stand upright for 1 hour. Follow the Storage Procedure above.

pH CLEANING PROCEDURE

- **General** Soak in Hanna [HI7061](#) or [HI8061](#) General Cleaning Solution for approximately 30 minutes.
- **Protein** Soak in Hanna [HI7073](#) Protein Cleaning Solution for 15 minutes.
- **Inorganic** Soak in Hanna [HI7074](#) Inorganic Cleaning Solution for 15 minutes. This is good at cleaning a black ceramic junction.
- **Oil/grease** Rinse with Hanna [HI7077](#) or [HI8077](#) Oil and Fat Cleaning Solution.

IMPORTANT: After performing any of the cleaning procedures, rinse the electrode thoroughly with distilled water, refill the reference chamber with fresh electrolyte (not necessary for gel-filled electrodes) and soak the electrode in [HI70300](#) or [HI80300](#) Storage Solution for at least 1 hour before taking measurements.

SYMPTOMS	PROBLEM	SOLUTION
Slow response/excessive drift	Dirty pH electrode. Dirty reference junction.	Soak the electrode tip in HI7061 solution for 30 min. and then clean the electrode. Soak in HI7074 .
Readings fluctuate up and down (noise).	Clogged/dirty junction. Low electrolyte level (refillable electrodes only).	Clean the electrode. Refill with fresh solution (for refillable electrodes only).
The LCD displays “_” during measurements (pH, mV, mV Rel or ISE).	Out of range in the appropriate scale.	Check to see if the pH bulb and reference junction are in the solution. Make sure the sample is in the specified range. Check the electrolyte level and the general state of the pH/ORP or ISE electrode.
Out of range in the mV scale.	Dry reference junction.	Soak in HI70300 Storage solution for at least one hour.
The instrument does not work with the temperature probe.	Out of order temperature probe.	Replace the probe.
The meter fails to calibrate or gives faulty readings.	Broken or out of order electrode.	Replace the electrode.
Explicit warnings are displayed during calibration.	Dirty/broken electrode, contaminated buffers.	Follow displayed instructions.
The electrode condition is not displayed after calibration.	Only one-point calibration has been performed.	Perform at least a two-point calibration.
The instrument does not start up.	Internal or software error.	Restart the instrument using the power switch or unplug adapter. If the error persists, contact your vendor.

The resistance of glass electrodes partially depends on the temperature. The lower the temperature, the higher the resistance. It takes more time for the reading to stabilize if the resistance is higher.

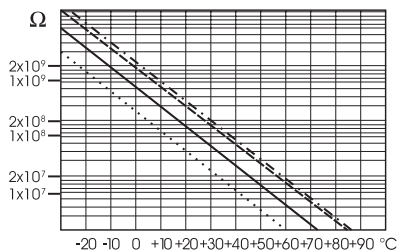

Since the resistance of the pH electrode is in the range of 50 – 200 MΩ, the current across the membrane is in the pico Ampere range. Large currents can disturb the calibration of the electrode for many hours.

The pH electrode’s life also depends on the temperature. If constantly used at high temperatures, the electrode life is drastically reduced.

Typical Electrode Life

Ambient Temperature	1 – 3 years
90 °C (194 °F)	Less than 4 months
120 °C (248 °F)	Less than 1 month

Alkaline Error

High concentrations of sodium ions interfere with readings in alkaline solutions. The pH at which the interference starts to be significant depends upon the composition of the glass. This interference is called alkaline error and causes the pH to be underestimated.

pH BUFFER SOLUTIONS

HI6016	pH 1.679 Buffer Solution, 500 mL bottle
HI6003	pH 3.000 Buffer Solution, 500 mL bottle
HI8004L	pH 4.01 Buffer Solution in FDA approved bottle, 500 mL
HI6004	pH 4.010 Buffer Solution, 500 mL bottle
HI8006L	pH 6.86 Buffer Solution in FDA approved bottle, 500 mL
HI6068	pH 6.862 Buffer Solution, 500 mL bottle
HI8007L	pH 7.01 Buffer Solution in FDA approved bottle, 500 mL
HI6007	pH 7.010 Buffer Solution, 500 mL bottle
HI8009L	pH 9.18 Buffer Solution in FDA approved bottle, 500 mL
HI8010L	pH 10.01 Buffer Solution in FDA approved bottle, 500 mL
HI6010	pH 10.010 Buffer Solution, 500 mL bottle
HI6124	pH 12.450 Buffer Solution, 500 mL bottle

ELECTRODE STORAGE SOLUTIONS

HI70300L	Storage Solution, 500 mL bottle
HI80300L	Storage Solution in FDA approved bottle, 500 mL

ELECTRODE CLEANING SOLUTIONS

HI70000P	Electrode Rinse Sachets, 20 mL, 25 pcs
HI7061L	General Purpose Solution, 500 mL bottle
HI7073L	Protein Cleaning Solution, 500 mL bottle
HI7074L	Protein Cleaning Solution, 500 mL bottle
HI7077L	Oil & Fat Cleaning Solution, 500 mL bottle
HI8061L	General Purpose Solution in FDA approved bottle, 500 mL
HI8073L	Protein Cleaning Solution in FDA approved bottle, 500 mL
HI8077L	Oil & Fat Cleaning Solution in FDA approved bottle, 500 mL

ELECTRODE REFILL ELECTROLYTE SOLUTIONS

HI7071	3.5M KCl + AgCl Electrolyte, 4x30 mL, for single junction electrodes
HI7072	1M KNO ₃ Electrolyte, 4x30 mL
HI7082	3.5M KCl Electrolyte, 4x30 mL, for double junction electrodes

HI8071	3.5M KCl + AgCl Electrolyte in FDA approved bottle, 4x30 mL, for single junction electrodes
HI8072	1M KNO ₃ Electrolyte in FDA approved bottle, 4x30 mL
HI8082	3.5M KCl Electrolyte in FDA approved bottle, 4x30 mL, for double junction electrodes
HI8093	1M KCl + AgCl Electrolyte in FDA approved bottle, 4x30 mL

ORP SOLUTIONS

HI7020L	Test Solution 200-275 mV, 500 mL bottle
HI7021L	Test Solution 240 mV, 500 mL bottle
HI7022L	Test Solution 470 mV, 500 mL bottle
HI7091L	Reducing Pretreatment Solution
HI7092L	Oxidizing Pretreatment Solution, 500 mL

pH ELECTRODES

All electrodes part numbers ending in B are supplied with a BNC connector and 1 m (3.3') cable, as shown below:

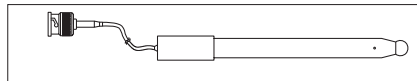

HI1043B

Glass body, double junction, refillable, combination pH electrode.

Use: strong acid/alkali.

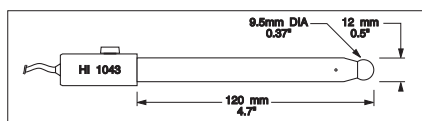

HI1053B

Glass body, triple ceramic, conical shape, refillable, combination pH electrode.

Use: emulsions.

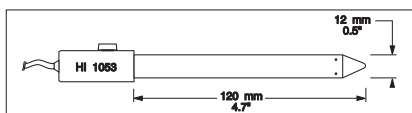

HI1083B

Glass body, micro, Viscolene, non refillable, combination pH electrode.

Use: biotechnology, micro titration.

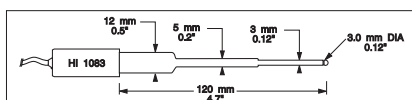
**HI1131B**

Glass body, refillable, double junction, combination pH electrode.

Use: general purpose.

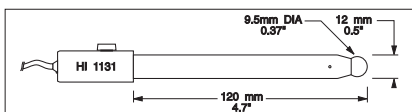
**HI1330B**

Glass body, semimicro, single junction, refillable, combination pH electrode.

Use: laboratory, vials.

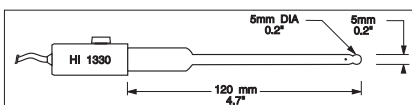
**HI1331B**

Glass body, semimicro, single junction, refillable, combination pH electrode.

Use: flasks.

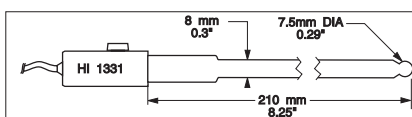
**HI1230B**

Plastic body (PEI), double junction, gel filled, combination pH electrode.

Use: general, field.

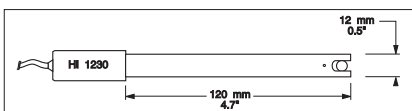

HI2031B

Glass body, semimicro, conical, single junction, refillable, combination pH electrode.

Use: semisolid products.

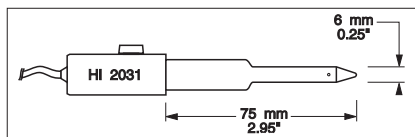

HI1332B

Plastic body (PEI), double junction, refillable, combination pH electrode.

Use: general purpose.

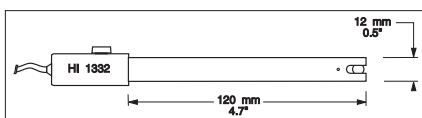

HI1413B

Glass body, single junction, flat tip, Viscolene, non refillable, combination pH electrode.

Use: surface measurement.

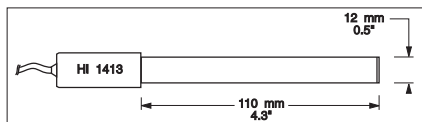

FC100B

Plastic body (PVDF), double junction, refillable, combination pH electrode.

Use: general purpose for food industry.

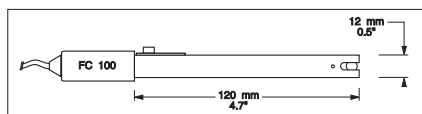

FC200B

Plastic body (PVDF), single junction, conical, Viscolene, non refillable, combination pH electrode.

Use: meat & cheese.

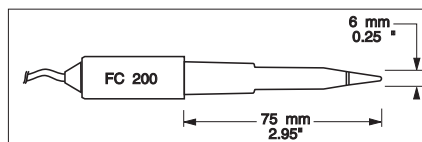

FC210B

Glass body, double junction, conical, Viscolene, non refillable, combination **pH** electrode.

Use: milk, yogurt.

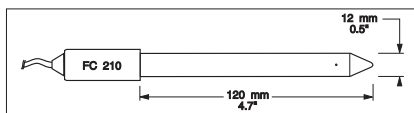
**FC220B**

Glass body, triple ceramic, single junction, refillable, combination **pH** electrode.

Use: food processing.

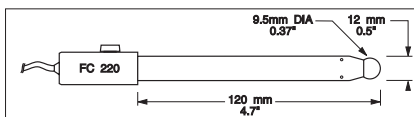
**FC911B**

Plastic body (PVDF), double junction, refillable with built-in amplifier, combination **pH** electrode.

Use: very high humidity.

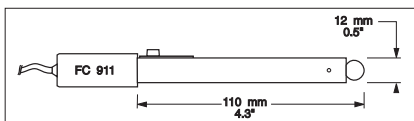
**ORP ELECTRODES****HI3131B**

Glass body, refillable, combination platinum **ORP** electrode.

Use: titration.

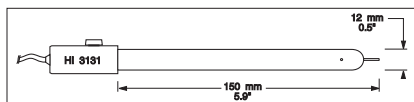
**HI3230B**

Plastic body (PEI), gel filled, combination platinum **ORP** electrode.

Use: general purpose.

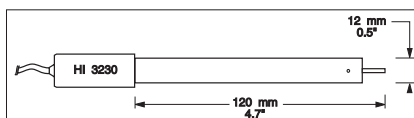

HI4430B

Plastic body (PEI), gel filled, combination gold **ORP** electrode.

Use: general purpose.

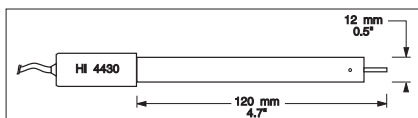

Consult the Hanna General Catalog for more electrodes with screw-type or BNC connectors.

**EXTENSION CABLE FOR SCREW-TYPE ELECTRODES
(SCREW TO BNC ADAPTER)**

HI7855/1 Extension cable 1 m (3.3') long

HI7855/3 Extension cable 3 m (9.9') long

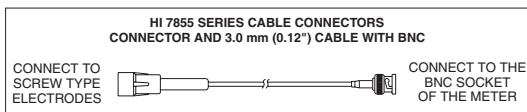

OTHER ACCESSORIES

HI710005/8	Voltage adapter from 120 Vac / 12 Vdc 800 mA (USA plug)
HI710006/8	Voltage adapter from 230 Vac / 12 Vdc 800 mA (European plug)
HI76404W	Electrode holder
HI8427	pH and ORP electrode simulator with 1 m (3.3') coaxial cable ending in female BNC connectors
HI931001	pH and ORP electrode simulator with LCD and 1 m (3.3') coaxial cable ending in female BNC connectors
HI7662-W	Temperature probe with 1 m (3.3') cable
HI92000	Windows® compatible software
HI920013	USB cable

Recommendations for Users

Before using this product, make sure that it is entirely suitable for your specific application and for the environment in which it is used.

Operation of this instrument may cause interference to other electronic equipment, requiring the operator to take steps to correct interference. Any variation introduced by the user to the supplied equipment may degrade the instrument's EMC performance.

To avoid damages or burns, do not put the instrument in microwave ovens. For your and the instrument's safety, do not use or store the instrument in hazardous environments.

Warranty

HI5221 and HI5222 are warranted for two years against defects in workmanship and materials when used for its intended purpose and maintained according to instructions. Electrodes and probes are warranted for six months. This warranty is limited to repair or replacement free of charge. Damage due to accidents, misuse, tampering or lack of prescribed maintenance is not covered. If service is required, contact your local Hanna Office. If under warranty, report the model number, date of purchase, serial number and the nature of the problem. If the repair is not covered by the warranty, you will be noticed of the charges incurred. If the instrument is to be returned to Hanna Instruments, first obtain a Returned Goods Authorization (RGA) number from the Technical Service department and then send it with shipping costs prepaid. When shipping any instrument, make sure it is properly packed for complete protection.

Hanna Instruments reserves the right to modify the design, construction or appearance of it's products without advance notice.

World Headquarters

Hanna Instruments Inc.
Highland Industrial Park
584 Park East Drive
Woonsocket, RI 02895 USA
www.hannainst.com

Local Office

Hanna Instruments USA
270 George Washington Highway
Smithfield, RI 02917
Phone: 800.426.6287
Fax: 401.765.7575
e-mail: tech@hannainst.com

Local Sales and Customer Service Office



MAN5222 05/16

Printed in ROMANIA